

Sandstrøm^{AV}

Full Motion TV Mount for Large TVs

Instruction Manual

SFML16

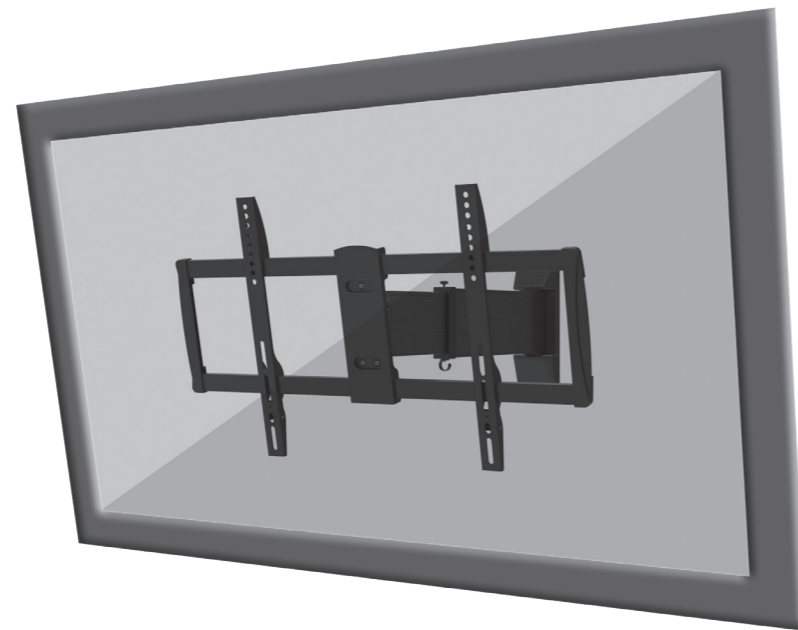

Thank you for purchasing your new product.

Please follow this quick start guide for a successful first time set up.

Read all the safety instructions carefully before use and keep the quick start guide for future reference.

SAFETY

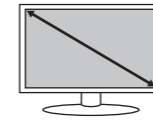

TV SIZE
37" - 75"



TV LOAD
40 kg

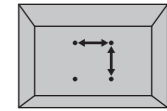

VESA COMPLIANCE
200 x 200 - 600 x 400 mm

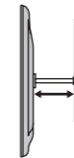

DISTANCE TO WALL
55 - 680 mm

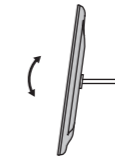

TILT ANGLE
-12° ~ +8°

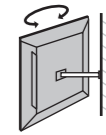

SWIVEL ANGLE
-90° ~ 90°

WARNING! READ THE FOLLOWING BEFORE STARTING INSTALLATION

- Assembly is required. Installation must be carried out by qualified personnel only. Incorrect assembly can result in severe personal injury and property damage.
- The supplied TV bracket is only for use on vertical walls constructed from solid brick, solid concrete, solid wood and solid wooden columns.
- It is the installers' responsibility to verify that the wall will safely support the total load of the TV and the TV bracket. Never exceed the designated maximum TV load.
- Parts are heavy; take care when handling. For some steps, 2 people are required for installation.
- Check the TV bracket frequently to ensure that it is safe and secure. Additional tools (not included) are required for the installation. Do not over-tighten screws.
- Keep this instruction manual for future reference.

Currys.co.uk

All the support you need.

Whether it's a tech emergency or you need plain good advice, we're always on hand to help.
UK: 0344 561 1234
IRE: 1890818 575

Partmaster
co.uk

Visit Partmaster.co.uk today for the easiest way to buy electrical spares and accessories. With over 1 million spares and accessories available we can deliver direct to your door the very next day. Visit www.partmaster.co.uk or call **0344 800 3456** (UK customers only) Calls charged at National Rate.



[Http://sandstromstyle.com](http://sandstromstyle.com)

Watch this video for quick assembling.

This Mount comes with a 3-year guarantee. If the product fails whilst in use for its intended purpose, please return it, along with your receipt, for a full refund or replacement. Please follow the instruction manual carefully when installing this device.

Currys Group Limited (co. no. 504877)
1 Portal Way, London, W3 6RS, UK

EU Representative
Currys Ireland Limited (259460)
3rd Floor Office Suite
Omni Park SC, Santry, Dublin 9, Republic of Ireland

IB-SFML16-211129V8

UNPACKING

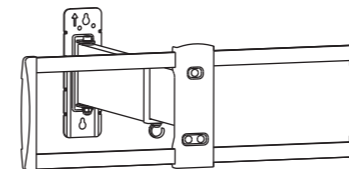

A1 × 4	A2 × 4	A3 × 4	A4 × 1	A5 × 1
A6 × 1	A7 × 2	A8 × 2		
B1 × 4	B2 × 4	B3 × 4	B4 × 4	
 Ø5 × 15mm	 Ø5 × 30mm	 Ø6 × 15mm	 Ø6 × 35mm	
B5 × 4	B6 × 4	B7 × 4		
 Ø8 × 20mm	 Ø8 × 35mm	 Ø8 × 50mm		
B8 × 4	B9 × 8	B10 × 4		
 Ø6-Ø8 × 5mm	 Ø6-Ø8 × 10mm	 Ø5 / Ø8		

