

# LOGIK

## 22" / 24" Full HD LED TV with DVD Player

Instruction Manual



L22FED12

---



L24FED12

---



# WE KNOWHOW™ TO HELP YOU WITH YOUR TV

We want you to be able to enjoy your new TV for many years. From getting it home and setting it up, to helping you to get the most out of your new purchase. And in the unlikely event your product lets you down, we can get it working again in no time.

Here are some of our TV services but if you want to know more look us up at [knowhow.com](http://knowhow.com) or call us on: **0844 561 1234**

## TV SET UP & DEMO

We'll assemble the stand and connect your new TV to the existing equipment. We'll tune your TV so it's ready to watch. We'll also give you a demonstration of your new TV's functions.

## TV WALLMOUNT & DEMO

We'll fix your TV to a suitable position on the wall and connect to your existing equipment, so it's all ready to go. We'll use neat wire management so you don't have to look at any untidy cabling and to complete your fuss-free installation, we'll test and demonstrate your TV's functions.

## FREESAT® SET UP & DEMO

We'll set up the Freesat® receiver and connect it to your existing dish, TV and cabling. We'll then tune in all available channels.

## AERIAL INSTALL & TUNE

We'll supply, install and align a new, high quality aerial and connect it to your Freeview receiver and TV. Then we'll scan and tune in all available digital channels.

## HOME THEATRE SET UP & DEMO

We'll un-box, connect and set up your new and existing equipment. We'll then configure, calibrate and optimise the equipment. To avoid ugly trailing cables, we'll clip them to your skirting board, if you'd like us to. Then we'll give you a demonstration.

## FAULT & FIX SERVICES

With our FAULT & FIX services, we can repair a wide range of products at our new state-of-the-art repair lab. This service is available for:

- Computer Desktops
- Laptops
- Netbooks
- TVs
- Games Consoles
- Sky & Freeview Digi Boxes



**KNOWHOW™**

at Currys. PC World. Dixons Travel. [Dixons.co.uk](http://Dixons.co.uk)

# Contents

---

<b>Preparation</b> .....	<b>5</b>
Unpacking the TV .....	5
Installing / Removing the Base Stand .....	6
Front / Right Side View and Controls.....	7
Rear View and Sockets.....	8
Installing Batteries in the Remote Control .....	9
Remote Control Operation Range.....	9
Remote Control .....	10
<b>Connections</b> .....	<b>13</b>
Making Video and Audio Connections.....	13
Connecting an AV Device Using an HDMI Cable.....	13
Connecting a Computer Using a VGA Cable .....	14
Connecting an AV Device Using a Component (YPbPr) Cable .....	14
Connecting an AV Device Using a SCART Cable .....	15
Connecting an AV Device Using Composite Cable .....	15
Connecting Headphones.....	16
<b>Initial Setup</b> .....	<b>17</b>
Turning the TV On for the First Time .....	17
– Target Region Descriptor.....	18
– Selecting the Input Source.....	18
– Channel Selection .....	19
– Display Channel Information .....	19
– Volume Adjustment.....	19
<b>Customising TV Settings</b> .....	<b>20</b>
Channel Setting (TV, DTV or Radio Mode).....	20
– Auto Tuning .....	20
– DTV Manual Tuning.....	21
– ATV Manual Tuning.....	21
– Channel Edit (ATV / DTV Mode).....	22
– Signal Information (DTV Mode).....	23
– CI (Common Interface) (DTV Mode).....	24
– Software Update (Over Air Download).....	25
– Software Update (USB).....	25
Picture Setting .....	26
Sound Setting .....	28
– Stereo / Dual Sound Reception (ATV Mode).....	29
Time Settings.....	29
Option Setting .....	30
– OSD Language.....	30
– Audio Language (DTV Mode).....	31
– Subtitle Language (DTV Mode) .....	32
– Hearing Impaired.....	32
– Country.....	32
– PVR File System (DTV Mode).....	33
– CEC (Consumer Electronics Control) .....	34
– Restore Factory Default.....	34
Lock Setting .....	35
– Lock System .....	35
– Set Password .....	36
– Block Channel .....	37
– Parental Guidance .....	38

<b>Using the Features .....</b>	<b>39</b>
EPG (Electronic Programme Guide) (DTV Mode) .....	39
– Switch On / Off EPG.....	39
– Select a Programme .....	39
Teletext (ATV Mode).....	40
– To Turn on Teletext Function.....	40
Digital Teletext (DTV Mode).....	41
– Teletext within Digital Service.....	41
<b>Entertainment .....</b>	<b>42</b>
Connecting a USB Storage Device.....	42
Viewing Photos.....	42
Listening to Music.....	43
Viewing Movies .....	44
My Text.....	45
<b>PVR (Personal Video Recorder).....</b>	<b>46</b>
Time Shift Function.....	46
Recording DTV Programme onto a USB Storage Device .....	47
Timer Programming .....	48
Play Recorded Programme .....	49
<b>Using the DVD Features.....</b>	<b>50</b>
Using the Built-in DVD Player .....	50
Compatible Disc Types .....	50
– Supported Formats.....	50
– Region Code .....	50
Basic DVD Playback Functions .....	51
– Playing the DVD .....	51
– Menu Playback (for DVD).....	51
– Stopping Playback.....	51
– Previous / Next (for DVD / CD / Multimedia discs) .....	51
– Forward / Backward (for DVD / CD / Multimedia discs).....	51
– Pause (for DVD / CD / Multimedia discs) .....	51
– Repeat (for DVD / CD / Multimedia discs) .....	51
– Display (for DVD / Multimedia discs).....	52
– Goto (for DVD / CD / Multimedia discs) .....	52
– Audio (for DVD / CD).....	52
– Repeat A-B (for DVD / CD).....	52
Program (for DVD) .....	52
Playing Multimedia Discs.....	53
Using the DVD Language Setup Page.....	55
Using the DVD Video Setup Page .....	55
Using the DVD Rating Setup Page.....	56
Using the DVD Misc Setup Page.....	56
<b>Maintenance .....</b>	<b>57</b>
<b>Hints and Tips .....</b>	<b>58</b>
<b>Display Modes .....</b>	<b>60</b>
YPbPr Mode .....	60
PC Mode .....	60
HDMI Mode .....	60
<b>Specifications .....</b>	<b>61</b>
<b>Safety Warnings .....</b>	<b>63</b>

**Thank you** for purchasing your new Logik 22" / 24" Full HD LED TV with DVD Player. Your new TV has many features and incorporates the latest technology to enhance your viewing experience. We recommend that you spend some time reading this instruction manual so that you fully understand these features. You will also find some hints and tips to help you resolve any issues. Read all the safety instructions carefully before use and keep this instruction manual for future reference.

## Unpacking the TV

Remove all packaging from the TV. Retain the packaging. If you dispose of it please do so according to local regulations.

The following items are included:

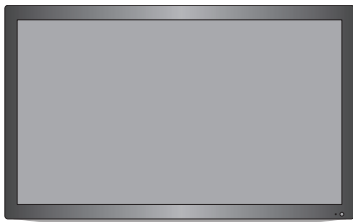

TV



TV Stand Support  
(P.N.: 115C2461101)



TV Base  
(P.N.: 102C2461113)



Remote Control / AAA Batteries x 2  
(P.N.: 504C1961101 & 32200007158)



Screw A x 1  
(P.N.: 209100422B1)



Screw B x 1  
(P.N.: 20912223101)



Instruction Manual  
(P.N.: 4031C226114)

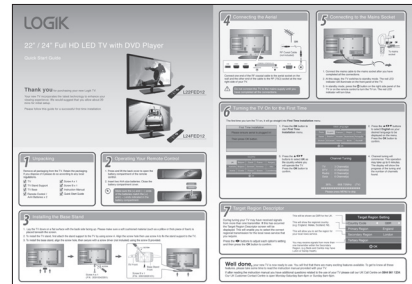

Quick Start Guide  
(P.N.: 4033C226120)

**GB**

Preparation



If items are missing, or damaged please contact Partmaster (UK only). Tel: 0844 800 3456 for assistance.

## Installing / Removing the Base Stand



The LCD display is very fragile, and must be protected at all times when installing and removing the base stand. Be sure that no hard or sharp object, or anything that could scratch or damage the LCD display, comes into contact with it. DO NOT exert pressure on the front of the TV at any time because the screen could crack.

1. Disconnect all cables connected to the TV.
2. Lay the TV down on a flat surface with the back side facing up. Please make sure a soft cushioned material (such as a pillow or thick piece of foam) is placed beneath the screen.
3. To install the TV stand, first attach the stand support to the TV by using screw A. Align the screw hole then use screw A to fix the stand support to the TV.

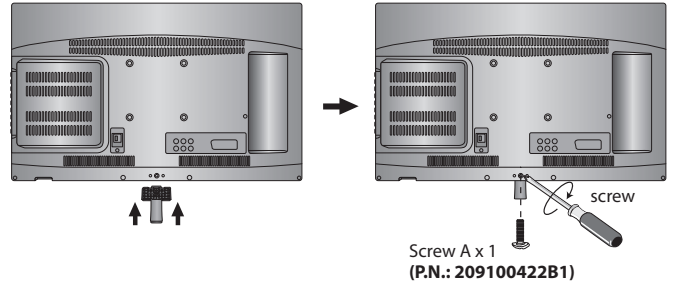

4. To install the base stand, align the screw hole, then secure with a screw driver (not included) using the screw B provided.

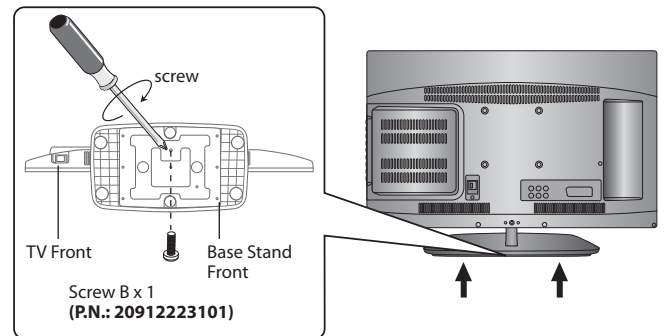

Remove the stand assembly before mounting the TV onto the wall.

5. To remove the stand assembly, untighten the screw holding the stand assembly to the rear of the TV. Slide the stand assembly out.



Keep all the spare screws should you want to use the stand assembly option.

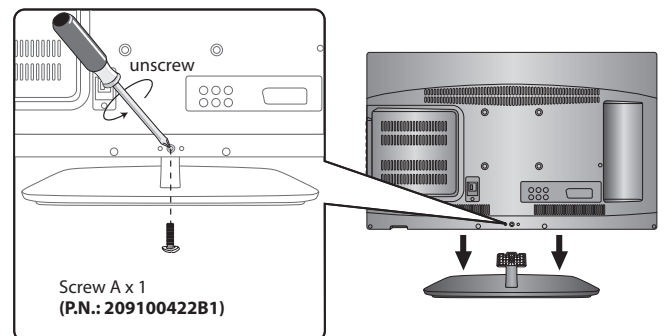

6. Mounting on the wall. This TV is designed to be wall-mounted with a standard 100 mm x 100 mm mounting kit (sold separately) designed for flat-panel TVs. Mount this TV according to the instructions included in the mounting kit. Due to space restrictions, we recommend that you make all connections (refer to page 18-21 and page 49 for details) before mounting on to the wall.

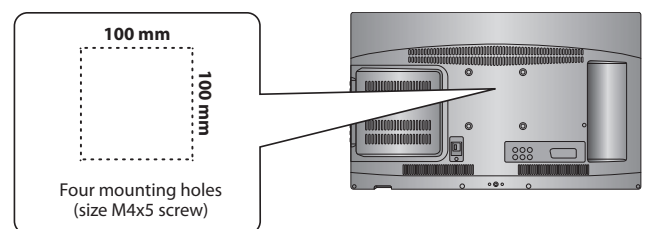

- Please read this instruction manual carefully while setting up your TV.
- If you require additional assistance please call our UK Call Centre on **0844 561 1234**. Our UK Customer Contact Centre is open Monday-Saturday 8am-8pm or Sunday 8am-6pm.

GB

Preparation

## Front / Right Side View and Controls

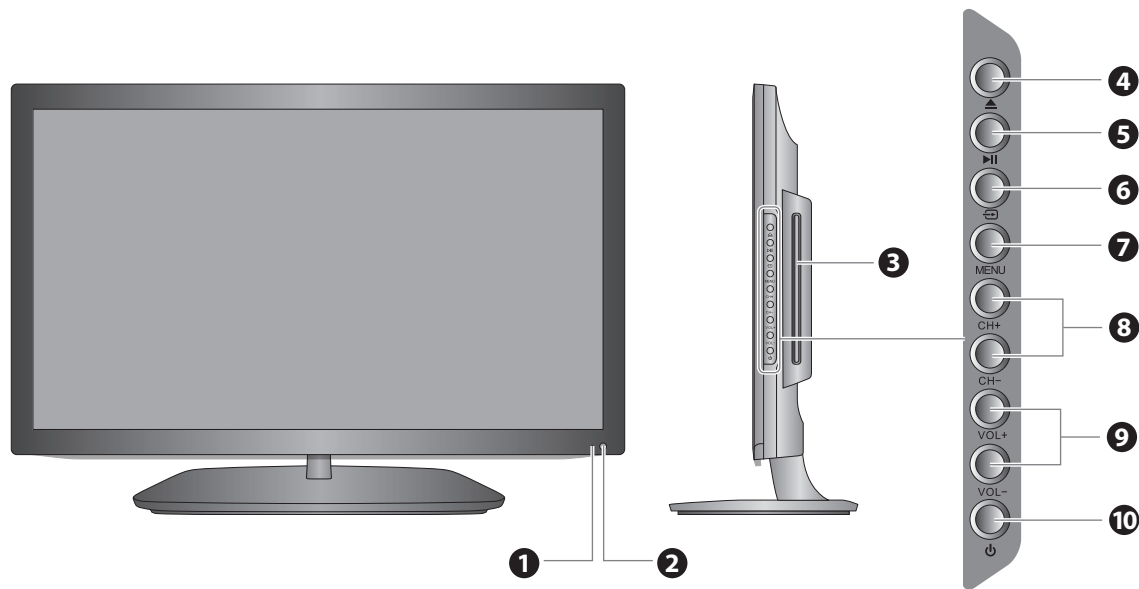

Item	Description
1 <b>POWER LED</b>	Illuminates blue when the TV is turned on. Illuminates red when the TV is in standby mode. The LED will flash blue and red when the timer programming has started in standby mode.
2 <b>IR (Infrared Receiver)</b>	Receives IR signals from the remote control. Do not put anything near the sensor, as its function may be affected.
3 <b>Disc Slot</b>	<b>L22FED12:</b> Insert a disc with the label side facing towards the front of the TV. (12 cm discs only. Don't insert 8 cm discs.) <b>L24FED12:</b> Insert a disc with the label side facing towards the rear of the TV. (12 cm discs only. Don't insert 8 cm discs.)
4 ▲	Press to eject disc. (DVD mode)
5 ▶	Press to start playback or pause. (DVD mode)
6 <b>INPUT</b>	Press to select among different input signal sources: DTV / ATV / SCART / YPbPr / PC / HDMI1 / HDMI2 / AV / DVD / USB. Use the ▲▼ buttons on the remote control to select the input, and then press the <b>OK</b> button to confirm.
7 <b>MENU</b>	Displays the OSD (on screen display) menu.
8 <b>CH + / -</b>	Press to select a channel or select a sub-menu from the OSD menu.
9 <b>VOL + / -</b>	Adjusts the volume. Press to select and adjust a setting in the OSD menu.
10	Switches the TV on from standby mode. Switches the TV back to standby mode.

## Rear View and Sockets

GB

Preparation

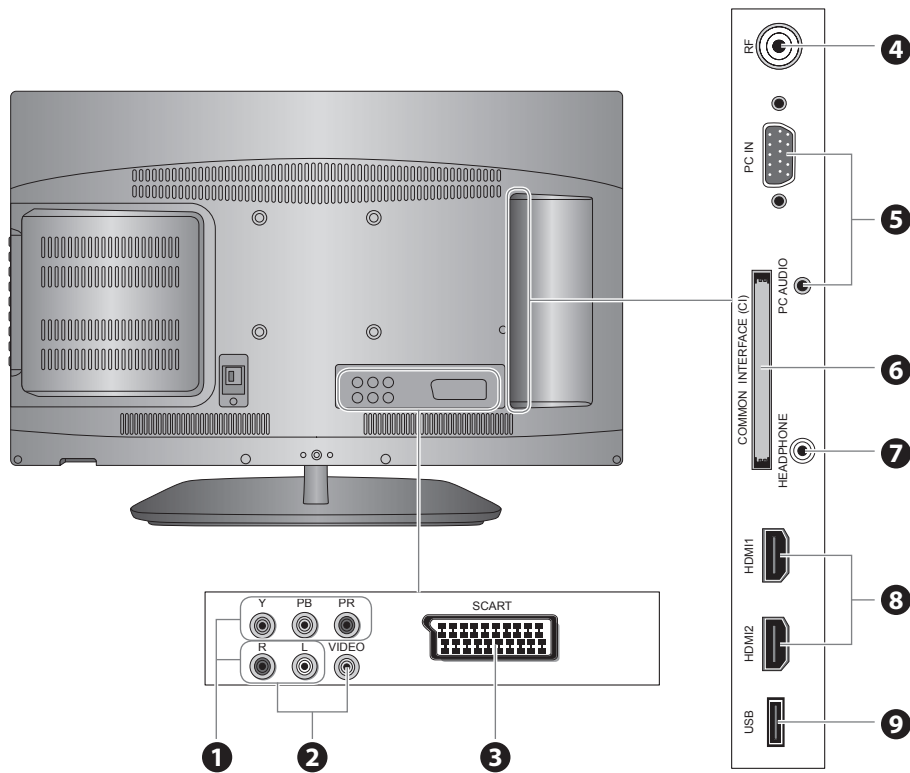

Socket	Description
1 <b>Y, PB, PR / AUDIO (L/R)</b>	Connects to a DVD player, Digital Set-Top-Box, or other AV devices with component (YPbPr) video and audio output sockets.
2 <b>VIDEO / AUDIO (L/R)</b>	Connects to the Composite VIDEO and AUDIO (L/R) output sockets on external video devices.
3 <b>SCART</b>	Connects to a VCR, DVD Player, or other AV device with a SCART output socket.
4 <b>RF Aerial</b>	Connects to the aerial socket on the wall with the RF coaxial cable.
5 <b>PC IN / PC AUDIO</b>	Connects to a computer or other devices with a VGA interface.
6 <b>COMMON INTERFACE</b>	Allows the insertion of a Common Access Module. (Refer to page 24 for details.)
7 <b>HEADPHONE</b>	Connects to the headphones.
8 <b>HDMI1 / HDMI2</b>	Connects to a High-Definition (HD) signal output device, such as a set-top box, blu-ray disc player or AV receiver.
9 <b>USB</b>	Allows the insertion of a USB storage device to play video, audio, photo and text files (USB mode) and record DTV programmes on to a USB storage device.

## Installing Batteries in the Remote Control

1. Press and lift the back cover to open the battery compartment of the remote control.

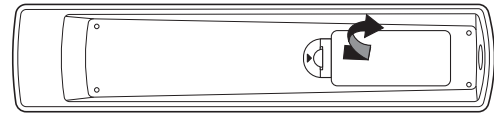

2. Insert two AAA size batteries. Make sure the (+) and (-) ends of the batteries match the (+) and (-) ends indicated in the battery compartment.

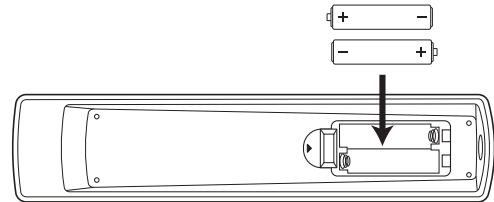

3. Close the battery compartment cover.



### Handling the Batteries

- Improper or incorrect use of batteries may cause corrosion or battery leakage, which could cause fire, personal injury or damage to property.
- Only use the battery type indicated in this manual.
- When the batteries are exhausted, the remote will not function. Replace both batteries at the same time with new ones.
- Do not install new batteries with used ones and do not mix different types of batteries.
- Do not dispose of used batteries as domestic waste. Dispose of them in accordance with local regulations.

### Handling the Remote Control

- Take care of your fingernails when you press and hold the battery release tab.
- Do not drop or cause impact to the remote control.
- Do not spill water or any liquid on the remote control.
- Do not place the remote control on a wet object.
- Do not place the remote control under direct sunlight or near sources of excessive heat.
- Remove the battery from the remote control when not in use for a long period of time, as it could cause corrosion or battery leakage and may result in physical injury and/or property damage including fire.

GB

Preparation

## Remote Control Operation Range

Point the remote control at the TV no more than 5 metres from the remote control sensor on the TV and within 60° in front of the TV. The operating distance may vary depending on the brightness of the room.

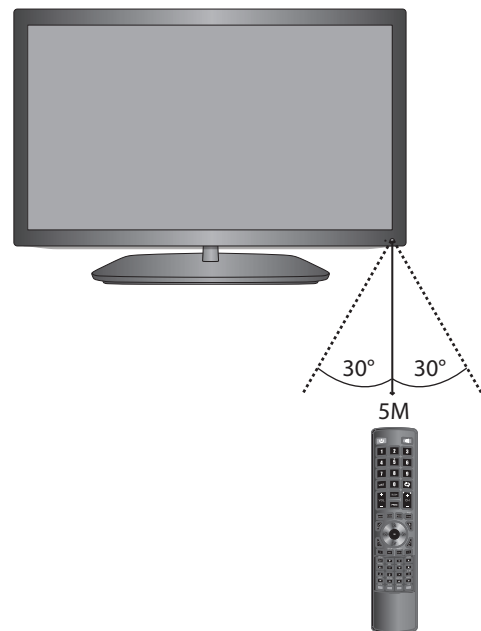

# Remote Control

GB

Preparation

1. **⏻**  
Switch the TV between on and standby mode.
2. **MUTE**  
Mute and restore your TV sound.
3. **0-9 Number Button**
  - Press to select a programme.
  - Select numbered items in a menu. (DVD mode)
4. **LIST**
  - Display the channel list. (ATV / DTV mode)
  - Display the text page on the teletext screen. (ATV mode)
5. **↺ RECALL**
  - Return to the previous viewing channel. (ATV / DTV mode)
  - Return to menu (DVD mode)
6. **SLEEP**  
Set the TV sleep timer: OFF / 10 / 20 / ... / 180 / 240 min.
7. **VOL + / -**  
Adjust the volume.
8. **CH + / -**  
Select a channel.
9. **PROG**
  - Display the channel edit menu. (ATV / DTV mode)
  - Programme the DVD. (DVD mode)
10. **S.MODE**  
Select sound mode: Standard / Music / Movie / Sports / User.
11. **ASPECT**  
Watch the screen in various formats: Auto / 4:3 / 16:9 / Zoom / Subtitle / Smart Zoom / Full.
12. **GUIDE**  
Displays the EPG Electronic Programme Guide. (DTV mode)
13. **TITLE**  
Display the DVD title content. (DVD mode)
13. **P.MODE**  
Select picture mode: Standard / Mild / User / Dynamic.
14. **MENU**  
Display the OSD (On Screen Display) menu.
15. **INPUT**  
Select among the different input signal sources:  
DTV / ATV / SCART / YPbPr / PC / HDMI1 / HDMI2 / AV / DVD / USB
16. **◀▶▶▶**  
Allows you to navigate the OSD menus and adjust the system settings to your preference.
17. **OK**  
Confirm the selection in the OSD menus.
17. **BACK**  
Return to the previous menu in the OSD menus.
18. **Exit**  
Exit the OSD menu.

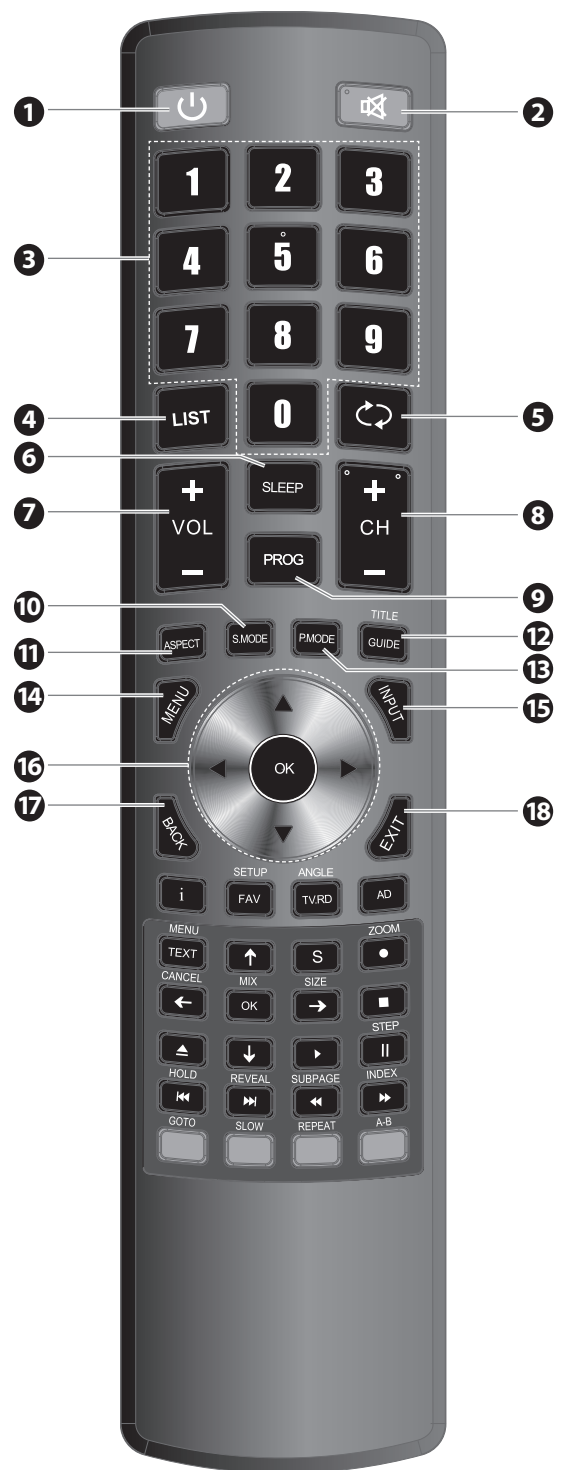

### 19. FAV

Display the favourite channel list. (ATV / DTV mode)

#### SETUP

Display and exit the DVD setup menu. (DVD mode)

### 20. i

Display the present screen information such as the current channel on ATV / DTV mode and the input source except ATV / DTV mode.

### 21. TV.RD

A short-cut to switch input source to TV / Digital radio channels.

#### ANGLE

Select different angles for the video. (DVD mode)

### 22. AD (Audio Description)

- Turn on / off the Audio Description (AD) function (only applicable when the TV programme has this feature). (DTV mode)
- Select different Audio mode on DVD mode. (DVD mode)
- Select Stereo / Dual Sound Reception. (ATV mode)

### 23. TEXT

Turn on and off the teletext function. (ATV / DTV mode)

#### MENU

Display the DVD menu. (DVD mode)

### 24. S (Subtitle)

- Display subtitles which are broadcast with the programme. (DTV mode)
- Display subtitles on the DVD. (DVD mode)

### 25. ● REC

Record the current programme. (DTV mode).

#### ZOOM

Zoom in on the displayed frame. (DVD mode)

### 26. ←↑↓→

Navigate the DVD menu and adjust the system settings to your preference. (DVD mode)

#### OK

Confirm the selection in the DVD menus. (DVD mode)

#### CANCEL

Exit the teletext mode. (ATV mode)

#### MIX

Select TELETEXT with a TV programme. (ATV mode)

#### SIZE

Enlarge the picture on the TV in teletext. (ATV mode)

### 27. ■ Stop

Stop the playback or recording. (DVD / USB / DTV mode)

### 28. ▲

Eject a disc. (DVD mode)

### 29. || Pause

- Pause playback. (DVD / USB mode)
- Start the time-shift function (DTV mode)

#### STEP

Play the playback forward frame by frame. (DVD mode)

### 30. ▶ PLAY

Start playback. (DVD / USB mode)

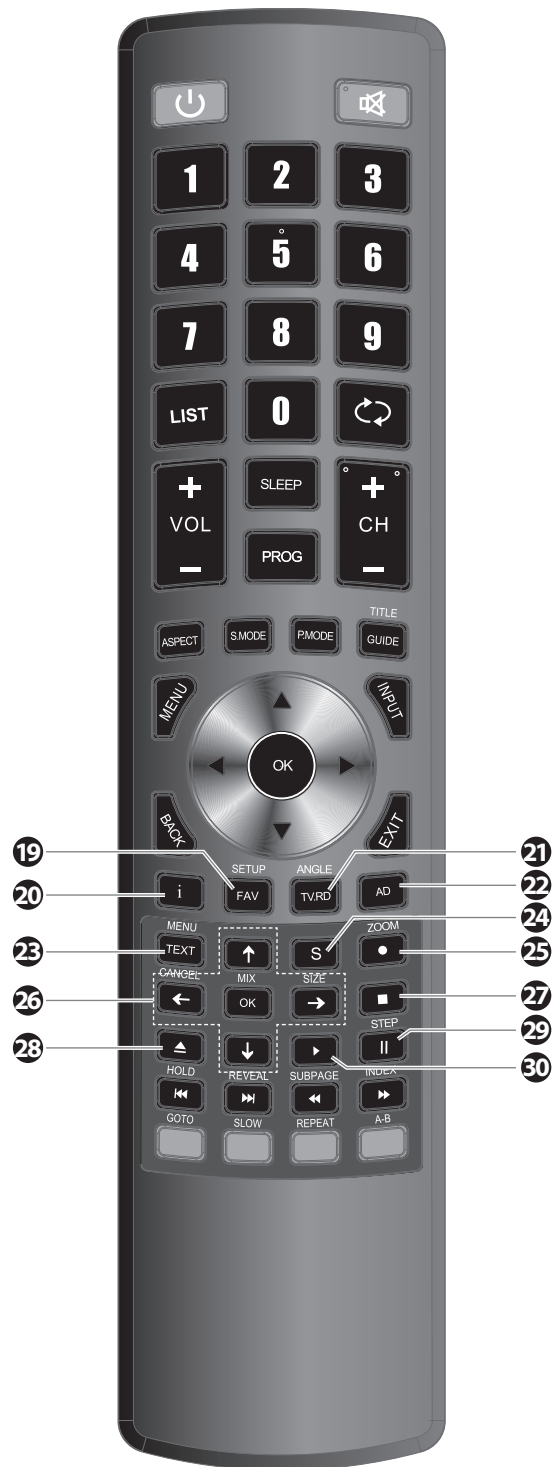

**31. ►►**

Skip to the beginning of the next chapter / track / photo. (DVD / USB mode)

**REVEAL**

Reveal hidden information such as the answer to a quiz in teletext. (ATV mode)

**32. ◀◀**

To skip to the beginning of the previous chapter / track / photo. (DVD / USB mode)

**HOLD**

Freeze a multi-page passage on screen in teletext. (ATV mode)

**33. ◀◀**

Reverse playback rapidly. (DVD / USB mode)

**SUBPAGE**

Display the subpage on the teletext screen. (ATV mode)

**34. ►►**

Advance playback rapidly. (DVD / USB mode)

**INDEX**

Select the page number of the index from teletext. (ATV mode)

**35. Coloured buttons**

Access the TELETEXT items or channel edit when using Digital / Freeview TV Channels. (ATV / DTV mode)

**GOTO (RED)**

Skip to a specific location on a DVD / CD. (DVD mode)

**SLOW (GREEN)**

Play video slowly. (DVD mode)

**REPEAT (YELLOW)**

Select between different repeat modes. (DVD mode)

**A-B (BLUE)**









Repeat a segment between A and B. (DVD mode)



## Making Video and Audio Connections





Not all AV devices have the ability to connect to a TV, please refer to the owner's manual of your AV device for compatibility and connection procedures.

When connecting any external AV device, do not connect the mains cable to the mains socket until all other connections are complete.

Best Video Performance	Signal Type	Separate Audio Connection Required
HDMI1 	HDMI (480i/480p/576i/576p/720p/1080i/1080p)	No
PC IN 	PC	Yes  PC AUDIO
Y PB PR 	Component Video (480i/480p/576i/576p/720p/1080i/1080p)	Yes 
SCART 	SCART (RGB Input)	No
VIDEO 	Composite Video	Yes 

## Connecting an AV Device Using an HDMI Cable

- This TV can accept High-Definition Multimedia Interface (HDMI) supports HDCP (High-Bandwidth Digital Content Protection) Protocol.
- This TV has a total of 2 HDMI input sockets, please make sure the correct input source is selected and corresponds to your connected HDMI input socket.
- When you connect to the output of an HD ready player (blu-ray disc player, game console, set-top box or computer) switch to the HDMI function and the TV will automatically detect the resolution used by the HDMI source.
- To get the best picture quality, adjust the blu-ray disc player, game console or set-top box output resolution up to 1920 x 1080p.

- Use an HDMI cable to connect the TV's HDMI input socket to the external AV device's HDMI output socket.
- Plug the connected devices into the mains socket before switching on the TV.
- Press the  button on the right side panel of the TV or on the remote control to turn on your TV.
- Press the  button on the right side panel of the TV or the **INPUT** button on the remote control to display the Source List. Use the   buttons to select **HDMI 1** / **HDMI 2** and then press the **OK** button to confirm.



Although this TV is able to connect to an HDMI device, it is possible that some devices may not operate correctly.

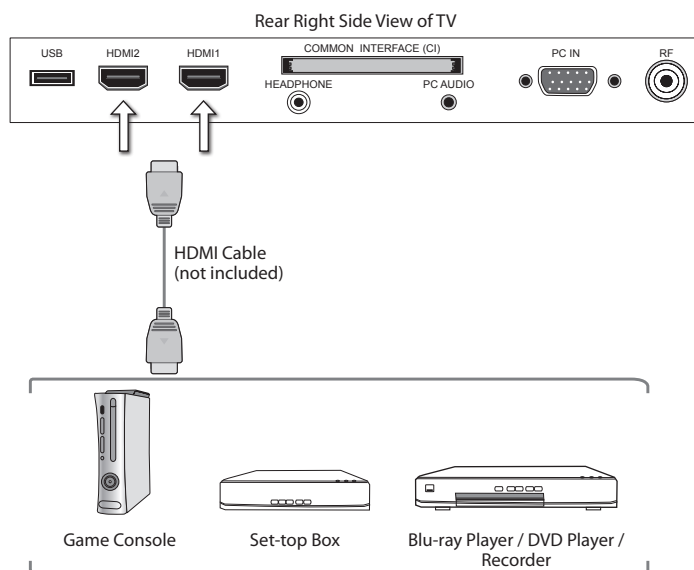

## Connecting a Computer Using a VGA Cable

1. Use a VGA cable to connect the TV's PC IN input socket to a computer's VGA output socket. Use an audio cable to connect the TV's PC AUDIO input socket to the computer's audio output socket.
2. Plug the connected devices into the mains socket before switching on the TV.
3. Press the **Power** button on the right side panel of the TV or on the remote control to turn on your TV.
4. Press the **Input** button on the right side panel of the TV or the **INPUT** button on the remote control to display the Source List. Use the **▲▼** buttons to select **PC** and then press the **OK** button to confirm.

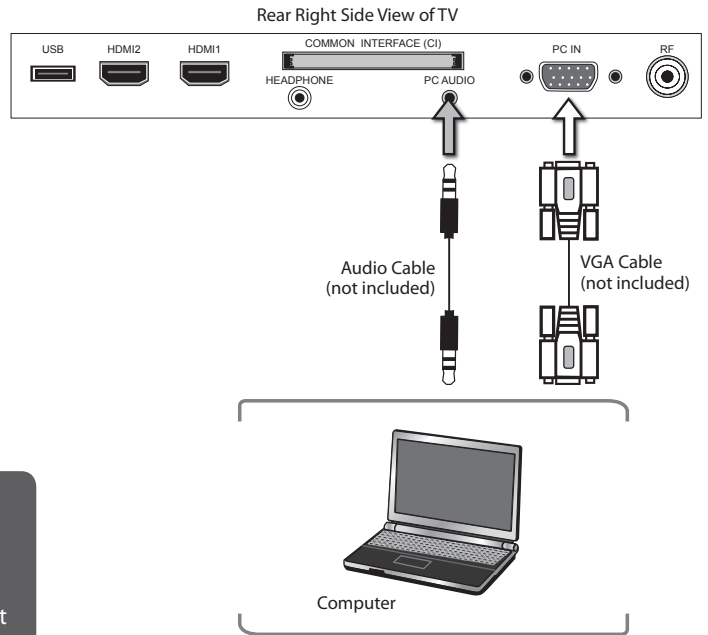

- The best resolution is 1920 x 1080.
- If your computer is set to shut down after a few minutes in the idle mode, the TV will also switch to standby due to no signal being received, this is to save energy. Press the **Power** button on the right side panel of the TV or on the remote control to restart the TV.

## Connecting an AV Device Using a Component (YPbPr) Cable

1. Use a component cable to connect the TV's YPbPr input sockets to an external AV device's component output sockets.
2. Use an AV cable to connect the TV's AUDIO(L/R) input sockets to the external AV device's component audio output sockets. (Audio Left = white, and Audio Right = red)

Component port on the TV	Y	Pb	Pr
Video output ports on DVD player	Y	Pb	Pr
	Y	Cb	Cr

3. Plug the connected devices into the mains socket before switching on the TV.
4. Press the **Power** button on the right side panel of the TV or on the remote control to turn on your TV.
5. Press the **Input** button on the right side panel of the TV or the **INPUT** button on the remote control to display the Source List. Use the **▲▼** buttons to select **YPbPr** and then press the **OK** button to confirm.

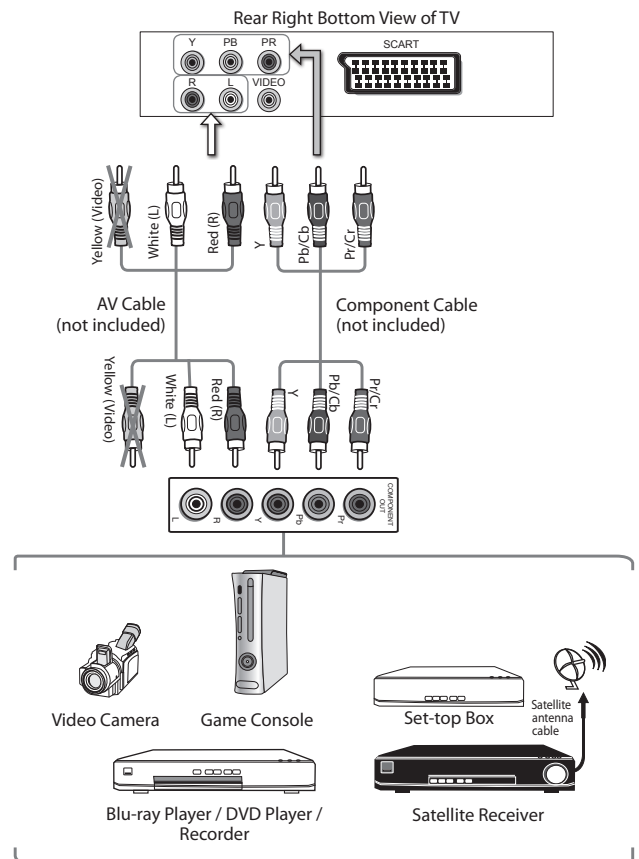

## Connecting an AV Device Using a SCART Cable



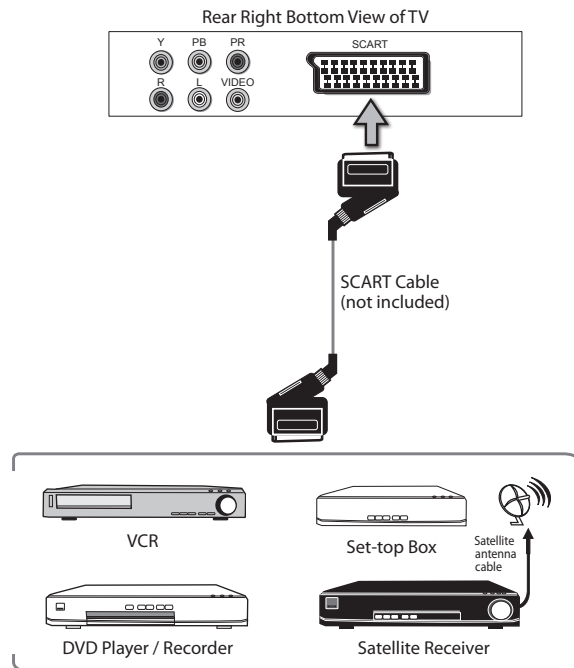

1. Use a SCART cable to connect the TV's SCART input socket to an external AV device's SCART output socket.
2. Plug the connected devices into the mains socket before switching on the TV.
3. Press the  button on the right side panel of the TV or on the remote control to turn on your TV.
4. The TV will change the input source to **SCART** automatically once the AV device is switched on.



GB

Connections

## Connecting an AV Device Using Composite Cable

1. Use an AV cable to connect the TV's AUDIO(L/R) / VIDEO input sockets to the external AV device's composite audio / video output sockets. (VIDEO = yellow, Audio Left = white, and Audio Right = red)
2. Plug the connected devices into the mains socket before switching on the TV.
3. Press the  button on the right side panel of the TV or on the remote control to turn on your TV.
4. Press the  button on the right side panel of the TV or the **INPUT** button on the remote control to display the Source List. Use the   buttons to select **AV** and then press the **OK** button to confirm.

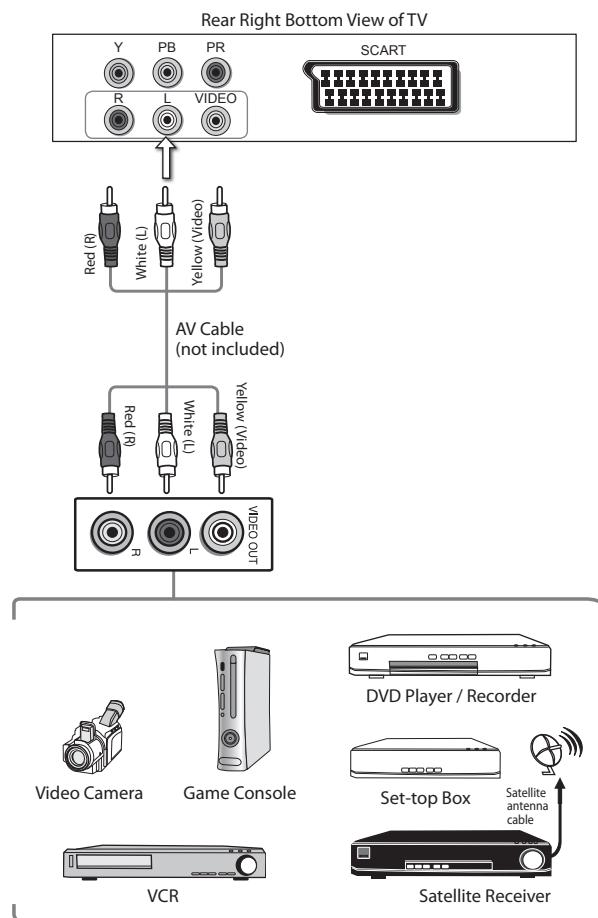

## Connecting Headphones

Connect your headphones to the TV's HEADPHONE socket.

Before putting on the headphones, turn the volume down then put the headphones on and slowly increase the volume until you reach a comfortable listening level.



Long-term exposure to loud music may cause hearing damage. It is best to avoid extreme volume when using headphones, especially for extended periods.

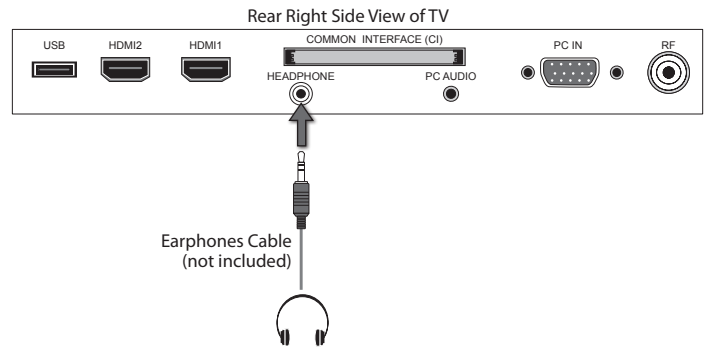



## Turning the TV On for the First Time

1. Connect one end of the RF coaxial cable to the aerial socket on the wall and the other end of the cable to the RF (75Ω) socket at the rear right side of your TV.

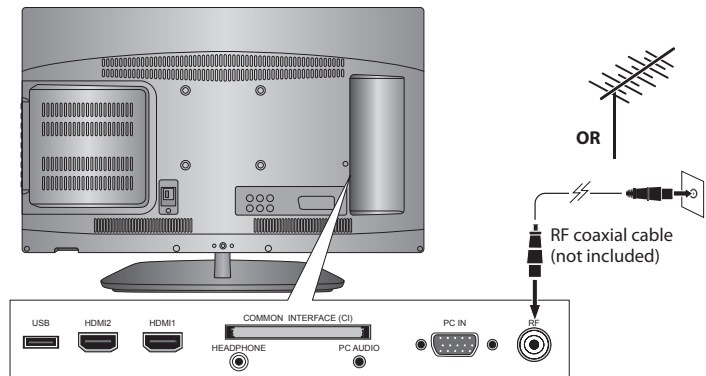

Do not connect the TV to the mains supply until you have completed all the connections.





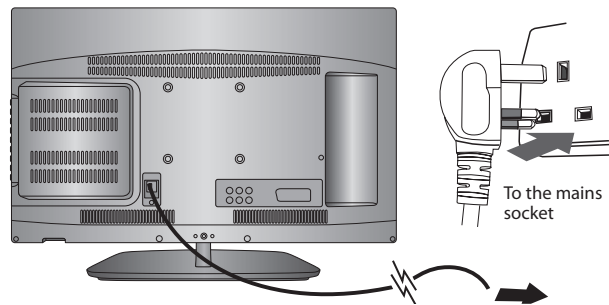

2. Connect the mains cable to the mains socket after you have completed all the connections.
3. At this stage, the TV switches to standby mode. The red LED indicator will illuminate on the front panel of the TV.
4. In standby mode, press the  button on the right side panel of the TV or on the remote control to turn the TV on. The red LED indicator will turn blue.



- Always disconnect the TV from the mains socket when not in use for a long period of time.
- The  button on the right side panel of the TV or on the remote control is only used for switching the TV into standby, it does not disconnect the TV from the mains power. To completely disconnect the mains power, please remove the mains plug from the mains socket.

5. The first time you turn the TV on, it will go straight into the **First Time Installation** menu. Please ensure the aerial is plugged in and then press the **OK** button. (If you have already installed the TV using the Quick Start Guide, please go to the section "**Selecting the Input Source**" on the next page.)

First Time Installation
Please ensure aerial is plugged in!
Then press OK button.

6. Press the     buttons to navigate the menu and change the settings. Press the **OK** button to confirm.

<b>OSD Language</b>	Select your desired language to be displayed on the menu. The default on-screen menu language is set as English.
<b>Country</b>	Select the country where you will operate the TV. The default country is set as UK.

OSD Language				
Česky	English	Français	Magyar	Polski
◀ Dansk	Español	Hrvatski	Nederlands	Português ▶
Deutsch	Ελληνικά	Italiano	Norsk	Русский
OK				

Country				
UK	Belgium	Czech	France	Hungary
◀ Australia	Bulgaria	Denmark	Germany	Italy ▶
Austria	Croatia	Finland	Greece	Luxembourg
OK				

GB

Initial Setup



## Channel Selection

- Press the **CH + / -** buttons on the remote control repeatedly or the **0-9** buttons to select the channel.



### Alternative



Press the **LIST** button to enter the **Channel List**. Then use the **▲▼** buttons to highlight and select the channel. Press the **OK** button to view the selected channel.

- If a blocked channel is selected, the password screen will be displayed. Press the **0-9** buttons to enter the password, the channel will then be unlocked (refer to page 37 for details on **Block Channel**).
- Press the **FAV** button to view the **Favourite List**. Then use the **▲▼** buttons to highlight and select the channel. Press the **OK** button to view the selected channel (refer to page 22-23 for details on **Channel Edit**).
- Press the  button to return to the previously viewed channel.

## Display Channel Information

- Press the **i** button to view the current information.

## Volume Adjustment

- Press the **VOL +** or **-** button on the side panel of the TV or on the remote control to adjust the volume.
- If you wish to switch the sound off, press the  **MUTE** button. Press the  **MUTE** button again or the **VOL +** or **-** button to resume audio listening.

# Channel Setting (TV, DTV or Radio Mode)

## Auto Tuning

Use this to automatically find and store all available channels. This is normally recommended if some channels have been added or removed by the broadcaster or if you have moved house.

1. Press the **MENU** button and then press the **▲▼** buttons to select the **CHANNEL** menu and then press the **OK** button.



2. Press the **▲▼** buttons to select **Auto Tuning** and then press the **OK** button.

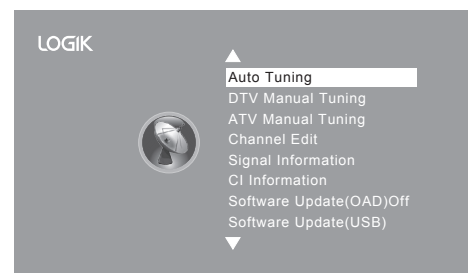

3. In the **Tune Type** menu, press the **◀▶** buttons to select **ATV / DTV / DTV + ATV**. Press the **▼** button and then press the **▲◀▶▼** buttons to select the country where you will operate the TV. Press the **OK** button to confirm.

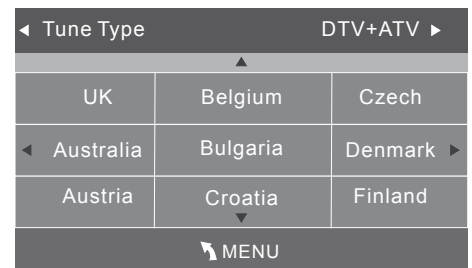

4. Channel tuning will commence. This operation may take up to 6 minutes. The display will show the progress of the tuning and the number of channels found.
5. If you want to skip the ATV tuning, press the **MENU** button to interrupt the tuning half way. A pop-up screen will be displayed, press the **◀** button to select **YES** to confirm. You will then go straight to DTV tuning. You may repeat the above step if you also want to skip the DTV tuning. An installation reminder will appear the next time you turn on the TV.
6. After tuning is complete, the channels are arranged in a preset order. If you wish to skip channels, modify the preset order or rename channels, select **Channel Edit** under the channel menu (refer to page 22-23 for details).

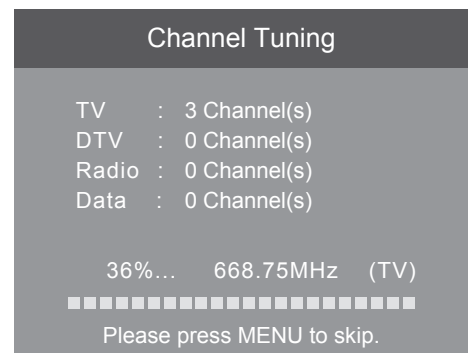

GB

Customising TV Settings

## DTV Manual Tuning

Allows you to make manual fine tuning adjustments to the channel under DTV mode.

1. Press the **MENU** button and then press the **▲▼** buttons to select the **CHANNEL** menu and then press the **OK** button.
2. Press the **▲▼** buttons to select **DTV Manual Tuning** and then press the **OK** button.
3. The DTV Manual Tuning screen will pop up. Press the **◀▶** buttons to select the desired UHF channel and then press the **OK** button to commence the search of that channel. When the signal has been tuned, the picture and signal strength will be displayed on the screen.
4. Press the **MENU** button to return to the main menu.
5. Press the **EXIT** button to exit the menu.

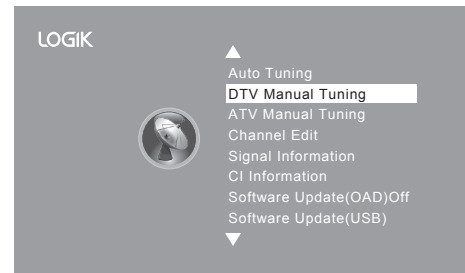

## ATV Manual Tuning

Allows you to make manual fine tuning adjustments if the channel reception is poor under ATV mode.

1. Press the **MENU** button and then press the **▲▼** buttons to select the **CHANNEL** menu and then press the **OK** button.
2. Press the **▲▼** buttons to select **ATV Manual Tuning** and then press the **OK** button.

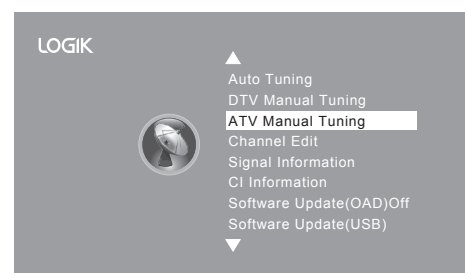
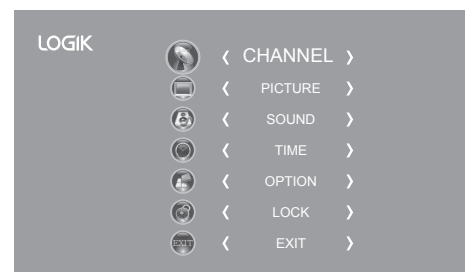

- The ATV Manual Tuning screen will pop up. Use the ▲▼ buttons to select the following options and the ◀▶ buttons to adjust the setting.

<b>Storage To</b>	Presets the channel number.
<b>Sound System</b>	Selects the sound system: I / DK / BG / L (for SECAM).
<b>Current CH</b>	Displays the current channel number.
<b>Search</b>	Press the ◀▶ buttons to start the manual tuning.
<b>Fine-Tune</b>	Press the ◀▶ buttons to make manual fine tuning adjustments.
<b>Frequency</b>	Displays the current tuned frequency.



- After finishing the manual tuning adjustment of a channel, press the **RED** button to save your channel before tuning the next channel.
- Press the **MENU** button to return to the main menu.
- Press the **EXIT** button to exit the menu.

### Channel Edit (ATV / DTV Mode)

Allows you to edit TV channel information in the Channel List.

- Press the **MENU** button and then press the ▲▼ buttons to select the **CHANNEL** menu and then press the **OK** button.



- Press the ▲▼ buttons to select **Channel Edit** and then press the **OK** button.

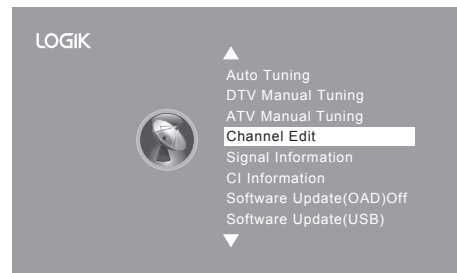

- A Channel Edit screen will pop up. Press the ▲▼ buttons to select the programme you want to edit.



All channels (DTV and ATV) are listed, please ensure that you edit the correct channel.

**a. Delete**

Press the **RED** button to delete the selected channel.

**b. Rename (ATV channels)**

Press the **GREEN** button to rename the selected channel. Press the ▲▼ buttons to select the characters to represent the station name. Press the ◀▶ buttons to move to the next character and then press the **GREEN** button again to confirm the new name.

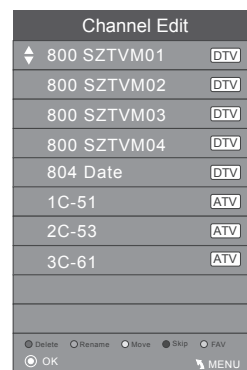

**c. Move**

Press the **YELLOW** button and then press the **▲▼** buttons to move to the selected channel. Press the **YELLOW** button or the **OK** button to confirm.

**d. Skip**

Press the **BLUE** button to skip the selected channel. Press the **BLUE** button again to undo it.

**e. FAV (Favourite)**

Press the **FAV** button to set the selected channel as one of the favourite programmes. Press the **FAV** button again to undo it.

4. Press the **MENU** button to return to the main menu.

5. Press the **EXIT** button to exit the menu.



Care should be taken when editing the position of digital channels as this may affect EPG and reminder settings.

### Signal Information (DTV Mode)

Allows you to view the signal information.

1. Press the **MENU** button and then press the **▲▼** buttons to select the **CHANNEL** menu and then press the **OK** button.

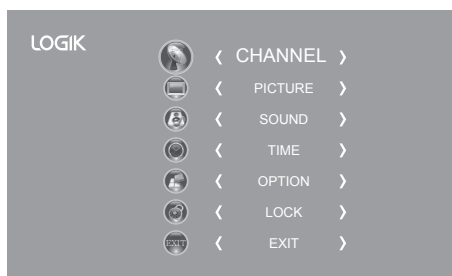

2. Press the **▲▼** buttons to select **Signal Information** and then press the **OK** button to view the signal information.

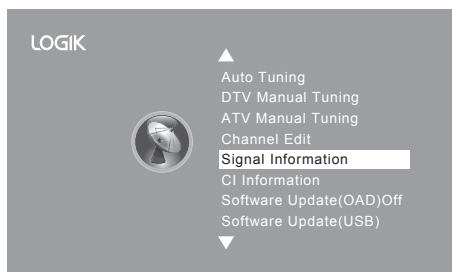

3. Press the **BACK** button to return to the previous menu or press the **MENU** button to return to the main menu.

4. Press the **EXIT** button to exit the menu.

Signal Information
Channel 52
Network SZTVM
Quality 99
Strength 81
Modulation 16QAM

## CI (Common Interface) (DTV Mode)

The common interface allows the use of a Common Access Module to enable you to view scrambled (pay to view) services. These services are provided by TopUp TV (UK only) and others. The Common Access Module and viewing card can be obtained from the service provider.



Do not repeatedly insert or remove the Common Access Module as this may damage the interface and cause a malfunction.

This feature is not available in all countries.

### To insert the Common Access Module

1. Before you insert the Common Access Module, ensure that the TV is switched off and the viewing card is inserted **in accordance with the Service Provider's instructions**.
2. Insert the Common Access Module into the slot. Flip the Common Access Module to another side and try again if you feel resistance.
3. Switch the TV on.

### To remove the Common Access Module

1. Before you remove the Common Access Module, ensure that the TV is switched off.
2. Pull the Common Access Module from the slot.
3. Switch the TV on.

### To view the module information

1. Press the **MENU** button and then press the **▲▼** buttons to select the **CHANNEL** menu and then press the **OK** button.
2. Press the **▲▼** buttons to select **CI Information** and then press the **OK** button.
3. A CI Information Main menu will pop up. Press the **▲▼** buttons to display the module information, smart card information, language, software download. Press the **OK** button to confirm.
4. Press the **EXIT** button to return to the previous menu. Press the **EXIT** button again to exit the menu.



This screen is for illustration only.

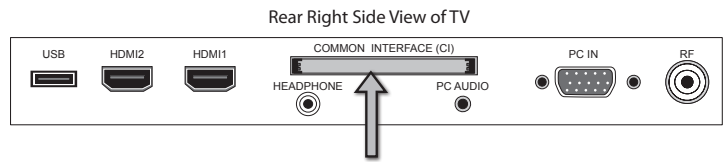

### CI (Common Interface)

Allows the Common Access Module to be inserted and access the content that has been encrypted.

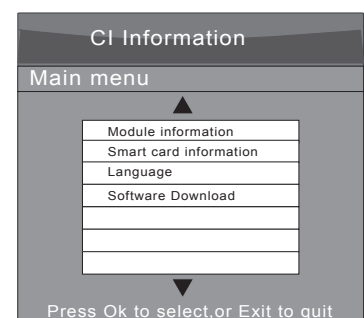
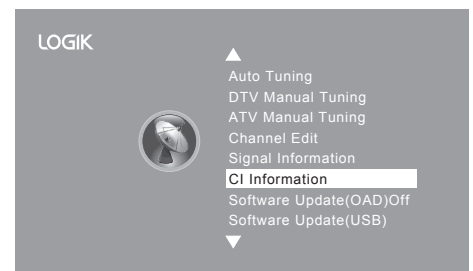
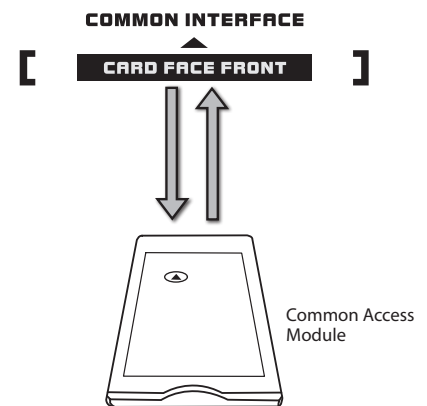

## Software Update (Over Air Download)

The TV auto detects the latest firmware through the DTV signal and allows you to accept or refuse the firmware upgrade service.

1. Press the **MENU** button and then press the **▲▼** buttons to select the **CHANNEL** menu and then press the **OK** button.
2. Press the **▲▼** buttons to select **Software Update(OAD)** and then press the **OK** button to select **On**.
3. Press the **BACK** button to return to the previous menu or press the **MENU** button to return to the main menu.
4. Press the **EXIT** button to exit the menu.
5. During normal DTV viewing, if the TV detects the latest firmware from the DTV signal, the Over Air Download screen will appear. Press the **◀▶** buttons to select **Yes / No** for the upgrade procedure.

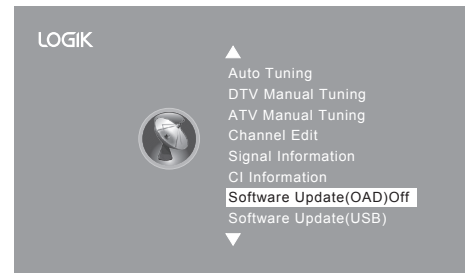

6. If you select **Yes**, the over air download will start. Press the **EXIT** button if you want to stop the download and exit the menu.



During download, please do not turn off or unplug your TV.

7. When the download is complete, the TV will automatically upgrade the software.
8. When the update is complete, the TV will return to standby mode.
9. Press the **⏻** button on the right side panel of the TV or on the remote control to switch on the TV.



If you experience difficulties after the software update, we recommend that you restore your TV to the factory default settings. To do this, follow the steps below:

1. Press the **MENU** button to go to the **MAIN** menu. Press the **▲▼** buttons to select **OPTION** and then press the **OK** button.
2. Press the **▲▼** buttons to select **Restore Factory Default** and then press the **OK** button. Press the **◀** button to select **Yes** to reset the setting.
3. The TV will restore all settings and go to the First Time Installation. Follow the **First Time Installation** steps (refer to page 17-19 for details).

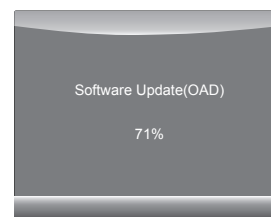
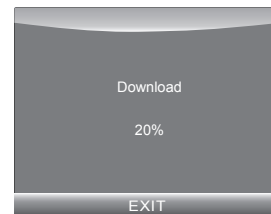

## Software Update (USB)

This function is only for servicing purposes. Any update information for this TV (if any) will be available at the following website: <http://knowhow.com/> or call our UK Call Centre on **0844 561 1234**. Our UK Customer Contact Centre is open Monday-Saturday 8am-8pm or Sunday 8am-6pm.

# Picture Setting

Allows you to set your preferred picture mode.

1. Press the **MENU** button and then press the **▲▼** buttons to select the **PICTURE** menu and then press the **OK** button.



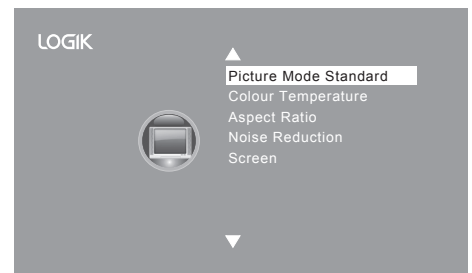

2. Press the **▲▼** buttons to select the following picture options and then press the **OK** button.

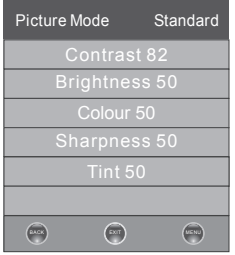
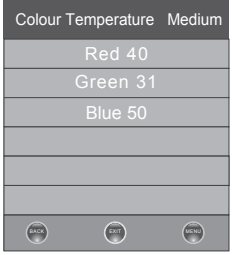

3. Press the **▲▼** buttons to select the options. Press the **OK** button and then press the **◀▶** buttons to adjust each option's setting.

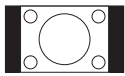
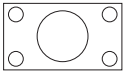
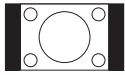
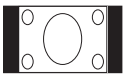
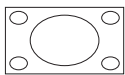
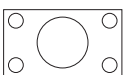
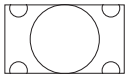
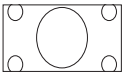
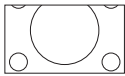
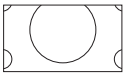
<b>Picture Mode</b>	Cycles among picture mode: Standard / Mild / User / Dynamic.		
	 <b>Alternative</b> _____ You may press the <b>P.MODE</b> button to select the picture mode directly.		
	<b>Contrast</b>	Adjusts the difference between light and dark levels in the picture (for User mode).	
	<b>Brightness</b>	Increases or decreases the amount of white in the picture (for User mode).	
	<b>Colour</b>	Controls the colour intensity (for User mode).	
	<b>Sharpness</b>	Adjusts the level of crispness in the edges between light and dark areas of the picture (for User mode).	
<b>Tint</b> (For NTSC format)	Adjusts the balance between red and green levels (Tint is only available for NTSC signal reception).		
<b>Colour Temperature</b>	Cycles among colour temperature: Medium / Cool / User / Warm. Adjusts the colour components independently to achieve a warm or cool (for User mode). <ul style="list-style-type: none"> <li>• <b>Red:</b> Increases red tint</li> <li>• <b>Green:</b> Increases green tint</li> <li>• <b>Blue:</b> Increases blue tint</li> </ul>		

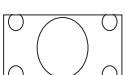
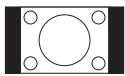
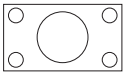
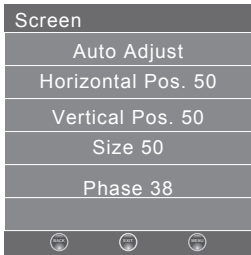
<b>Aspect Ratio</b>	Allows you to watch the screen in various picture formats: Auto / 4:3 / 16:9 / Zoom / Subtitle / Smart Zoom / Full.				
		<b>Input Signal 4:3</b>		<b>Input Signal 16:9</b>	
	<b>Auto</b>	This selection will display the picture according to the aspect ratio of the input source.		This selection will display the picture according to the aspect ratio of the input source.	
	<b>4:3</b>	This selection will allow you to view a picture with an original 4:3 aspect ratio. Black bars will appear on both the left and right of the screen.		This selection will allow you to adjust the picture horizontally, in linear proportion. Black bars will appear on both the left and right of the screen.	
	<b>16:9</b>	This selection will allow you to adjust the picture horizontally, in linear proportion, to fill the entire screen.		This selection will allow you to view a picture with an original 16:9 aspect ratio.	
	<b>Zoom</b>	This selection will allow you to zoom in the picture without any alteration, while filling the entire screen. However, the top and bottom of the picture will be cropped.		This selection will allow you to zoom in the picture without any alteration, while the 4 sides of the picture will be cropped.	
	<b>Subtitle</b>	This selection will allow you to zoom in the picture without any alternation, while filling the entire screen with subtitles shown at the bottom of the screen.		This selection will allow you to zoom in the picture without any alternation, while showing subtitles at the bottom of the screen.	
	<b>Smart Zoom</b>	This selection is similar to 16:9 mode, but the picture slightly stretches vertically and clips off a little from the top and bottom.		This selection is similar to 16:9 mode, but the picture slightly stretches vertically and clips off a little from the top and bottom.	
	<b>Full</b> (HDMI mode, PC mode and YPbPr mode only)	This selection will detect the resolution of the HDMI signal and display an image with the same number of pixels.		This selection will detect the resolution of the HDMI signal and display an image with the same number of pixels.	
<b>Noise Reduction</b>	Select to reduce the noise level of the connected device: <b>Off / Low / Middle / High.</b> (ATV mode)				
<b>Screen</b>	Allows you to adjust the PC desktop content. (PC mode only)				
	<b>Auto Adjust</b>	Allows you to synchronise a PC signal automatically.			
	<b>Horizontal Pos.</b>	Adjusts the position of the picture left and right in the window.			
	<b>Vertical Pos.</b>	Adjusts the position of the picture up and down in the window.			
	<b>Size</b>	Allows you to adjust the picture horizontally, in linear properties			
	<b>Phase</b>	Controls the signal phase, which can improve focus clarity and image stability based on the PC mode.			

4. Press the **BACK** button to return to the previous menu or press the **MENU** button to return to the main menu.
5. Press the **EXIT** button to exit the menu.

# Sound Setting

Allows you to select an audio-enhancement technique.

1. Press the **MENU** button and then press the **▲▼** buttons to select the **SOUND** menu and then press the **OK** button.



2. Press the **▲▼** buttons to select the following sound options and then press the **OK** button.

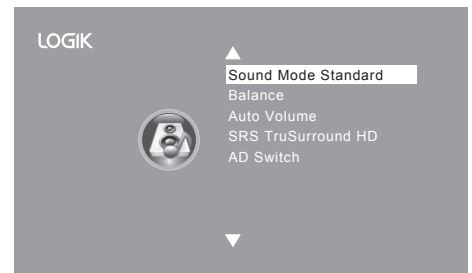

3. Press the **▲▼** buttons to select the options. Press the **OK** button and then press the **◀▶** buttons to adjust each option's setting.

<b>Sound Mode</b>	Allows the selection of an audio-enhancement technique: Standard / Music / Movie / Sports / User.	
	 <b>Alternative</b> You may press the <b>S.MODE</b> button to select the sound mode directly.	
	<b>Treble</b>	Controls the relative intensity of higher pitched sounds (for User mode).
	<b>Bass</b>	Controls the relative intensity of lower-pitched sounds (for User mode).
<b>Balance</b>	Adjusts the relative volume of the speakers in a multiple speaker system.	
<b>Auto Volume</b>	Volume levels are automatically controlled (e.g., advertisements tend to be louder than the programmes).	
<b>SRS TruSurround HD</b>	SRS TruSurround HD™ (TS HD) is a robust multichannel virtualisation technology developed by SRS Labs that provides an enhanced listening experience unlike any other technology that has been offered for a two speaker playback environment. TruSurround HD builds upon its predecessor, the industry leading surround sound virtualiser, SRS TruSurround XT®. Not only does TruSurround HD process up to 6.1 channels for playback over two speakers or headphones, but it also utilises additional proprietary algorithms from SRS Labs to optimise bass performance, for deep rich bass, dialogue clarity for better intelligibility of vocals, and definition control for maximum high-frequency clarity. Press the <b>OK</b> button to select <b>On / Off</b> .	
<b>AD Switch (for DTV mode)</b>	Audio Description is an auxiliary audio function that provides an additional audio track for visually challenged persons. This function handles the Audio Stream for the AD (Audio Description), when it is sent along with the main audio from the broadcaster. <ul style="list-style-type: none"> <li>• Set to "<b>Off</b>" for normal broadcasting sound coming out from speakers.</li> <li>• Set to "<b>On</b>" to activate the description sound track if available. The availability of Audio Description sound track is indicated by the visually impaired icon "<b>V.I.</b>" in the information banner.</li> </ul>	

4. Press the **BACK** button to return to the previous menu or press the **MENU** button to return to the main menu.
5. Press the **EXIT** button to exit the menu.

## Stereo / Dual Sound Reception (ATV Mode)

When a programme is selected, press the **AD** button to display the sound information for the selected station.

Broadcast	On Screen Display
Mono	MONO / NICAM MONO
Stereo	MONO / NICAM STEREO
Dual	MONO / NICAM DUAL I, NICAM DUAL II, NICAM DUAL I+II

### Mono sound selection

If the stereo signal is weak, you can switch to mono by pressing the **AD** button. In mono reception, the clarity of sound is improved. To switch back to stereo, press the **AD** button again.

### Language selection for dual language broadcast

If a programme can be received in two languages (dual language), you can switch to **NICAM DUAL I**, **NICAM DUAL II**, **NICAM DUAL I+II** or **MONO** by pressing the **AD** button repeatedly.

NICAM DUAL I	Sends the primary broadcast language to the loudspeakers
NICAM DUAL II	Sends the secondary broadcast language to the loudspeakers
NICAM DUAL I+II	Sends the primary and secondary broadcast languages to the loudspeakers

## Time Settings

Allows you to adjust power on / off time, sleep timer, auto standby and time zone.



1. Press the **MENU** button and then press the **▲▼** buttons to select the **TIME** menu and then press the **OK** button.



2. Press the **▲▼** buttons to select the following time options and then press the **OK** button.

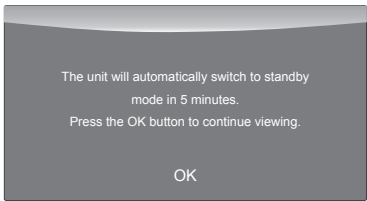

3. Press the ▲▼ buttons to select the options. Press the **OK** button and then press the ◀▶ buttons to adjust each option's setting.

<b>Clock</b>	The clock is set automatically when receiving a digital signal.
<b>Off Time</b>	Allows you to set the off time that will automatically switch off the TV. Cycle through and select from the following off time options: Off / Once / Every Day / Mon.~Fri. / Mon.~Sat. / Sat.~Sun. / Sunday.   Ensure your SCART device is turned off before entering the <b>On Time</b> menu. If your SCART device is turned on, the <b>On Time</b> menu will default to the SCART device.
<b>On Time</b>	Allows you to set the on time that the TV will automatically switch on the TV and tune to the source, channel and volume you select. Cycle through and select from the following on time options: Off / Once / Every Day / Mon.~Fri. / Mon.~Sat. / Sat.~Sun. / Sunday.
<b>Sleep Timer</b>	The sleep timer automatically switches the TV to standby after the preset time has elapsed. The clock will be set automatically when receiving a digital signal. Time must be set before using Sleep Timer function.  Press the ▲▼ buttons to select a period of time after which the TV automatically switches to standby mode: OFF / 10 / 20 / ... / 180 / 240 min. The timer begins to count down from the number of minutes selected.   If you turn the TV off after setting the sleep timer, the sleep timer setting will be erased.   <b>Alternative</b> <ol style="list-style-type: none"> <li>1. You may press the <b>SLEEP</b> button repeatedly to select the number of minutes: OFF / 10 / 20 / ... / 180 / 240 min directly.</li> <li>2. To cancel the sleep time, press the <b>SLEEP</b> button repeatedly until Off appears.</li> </ol>
<b>Auto Standby</b>	The unit will automatically switch to standby mode 4 hours after the last time the remote control was used. A reminder screen will pop up and count down before the unit switches to standby mode. To turn off the auto standby function, press the <b>MENU</b> button to display the main menu. Press the ▲▼ buttons to select the <b>Time</b> option and then press the <b>OK</b> button. Press the ▲▼ buttons to select the <b>Auto Standby</b> option and then press the <b>OK</b> button to select "Off". Press the <b>EXIT</b> button to exit the main menu. To save energy you should always turn the auto standby function back to "3H" or "4H".  
<b>Time Zone</b>	When you select a Time Zone, the TV time is set by the time offset information based on Time Zone and GMT (Greenwich Mean Time) which is received with the broadcast signal and the time is set automatically by a digital signal.

4. Press the **BACK** button to return to the previous menu or press the **MENU** button to return to the main menu.
5. Press the **EXIT** button to exit the menu.

## Option Setting

### OSD Language

Allows you to select your desired on screen menu language.

1. Press the **MENU** button and then press the ▲▼ buttons to select the **OPTION** menu and then press the **OK** button.

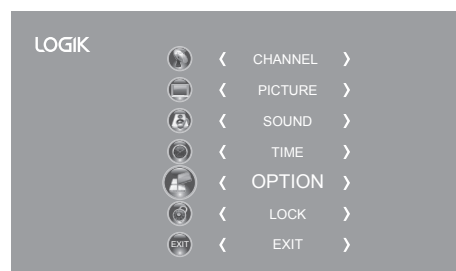

- Press the ▲▼ buttons to select **OSD Language** and then press the **OK** button. The default on-screen menu language is English.

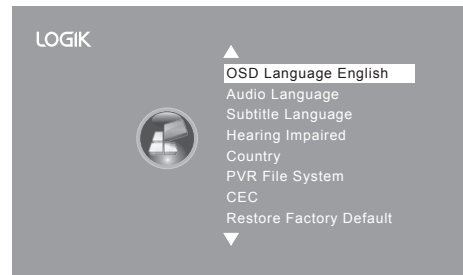

- Press the ▲◀▶▼ buttons to navigate the menu and change the settings. Press the **OK** button to confirm.
- Press the **BACK** button to return to the previous menu or press the **MENU** button to return to the main menu.
- Press the **EXIT** button to exit the menu.

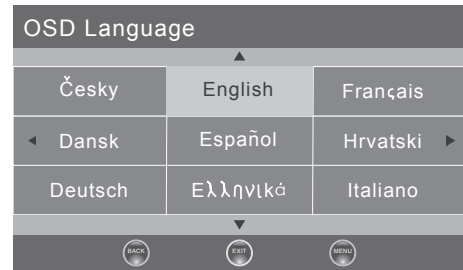

## Audio Language (DTV Mode)

Allows you to select your desired audio language. (Available for digital channels if multiple audio languages are broadcast.)

- Press the **MENU** button and then press the ▲▼ buttons to select the **OPTION** menu and then press the **OK** button.



- Press the ▲▼ buttons to select **Audio Language** and then press the **OK** button.

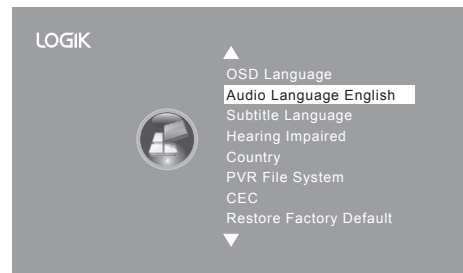

- Press the ◀▶ buttons to select the Primary / Secondary Audio Language. Press the ▼ button and then press the ▲◀▶▼ buttons to select your desired audio language. Press the **OK** button to confirm.
- Press the **BACK** button to return to the previous menu or press the **MENU** button to return to the main menu.
- Press the **EXIT** button to exit the menu.

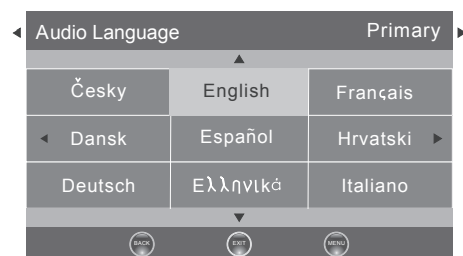

## Subtitle Language (DTV Mode)

Allows you to select your desired subtitle language or turn off the subtitle. (Available for digital channels if multiple subtitle languages are broadcast.)

1. Press the **MENU** button and then press the **▲▼** buttons to select the **OPTION** menu and then press the **OK** button.
2. Press the **▲▼** buttons to select **Subtitle Language** and then press the **OK** button.
3. Press the **◀▶** buttons to select the Primary / Secondary Subtitle Language. Press the **▼** button and then press the **▲◀▶▼** buttons to select your desired subtitle language. Press the **OK** button to confirm.
4. Press the **BACK** button to return to the previous menu or press the **MENU** button to return to the main menu.
5. Press the **EXIT** button to exit the menu.



While watching a DTV programme, you can press the **S** button on the remote control to display the **Subtitle Language List** and then press the **▲▼** buttons to select the **Subtitle Language OFF**. Press the **OK** button to confirm. (Only applicable when the TV programme has this feature.)

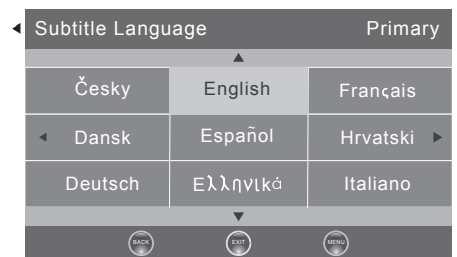
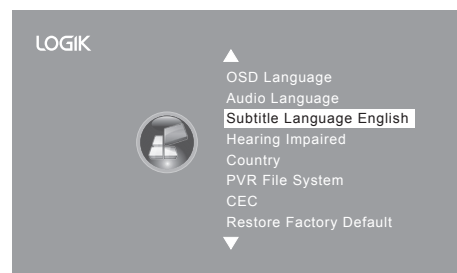
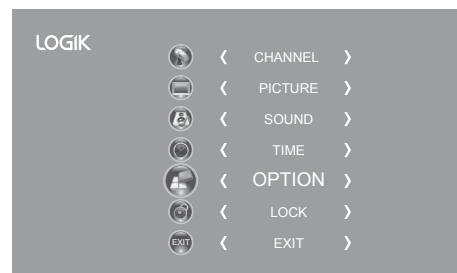

## Hearing Impaired

Shows information for the hearing-impaired in some programmes. (For DTV channels only if available.)

1. Press the **MENU** button and then press the **▲▼** buttons to select the **OPTION** menu and then press the **OK** button.
2. Press the **▲▼** buttons to select **Hearing Impaired** and then press the **OK** button to select **On / Off**.
3. Press the **BACK** button to return to the previous menu or press the **MENU** button to return to the main menu.
4. Press the **EXIT** button to exit the menu.

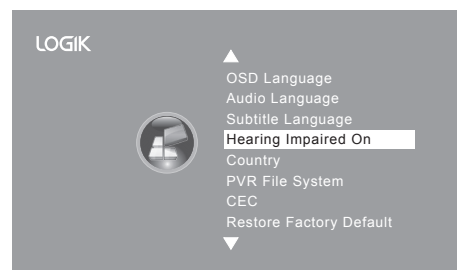
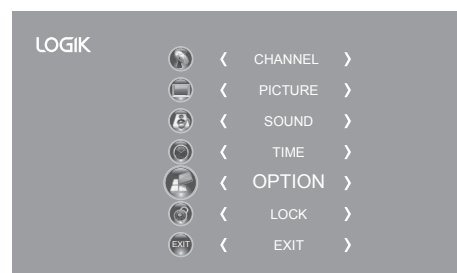

## Country

This shows the country you selected in auto tuning. If you want to change the country, please refer to **Auto Tuning** on page 20.

## PVR File System (DTV Mode)

Allows you to select your preferences in the PVR File System.

1. Press the **MENU** button and then press the **▲▼** buttons to select the **OPTION** menu and then press the **OK** button.



2. Press the **▲▼** buttons to select **PVR File System** and then press the **OK** button.



3. Press the **▲▼** buttons to select the following PVR File System options and then press the **OK** button.

<b>Select Disk</b>	Select the disk where you want to store your recorded content.	
<b>Check PVR File System</b>	Press the <b>OK</b> button, the system will now check your USB device's suitability for PVR. The system will show " <b>Checking</b> ". Upon the completion the system will show either " <b>SUCCESS</b> " or " <b>FAIL</b> ".	
<b>USB Disk</b>	If no USB storage device is connected, it will show " <b>No USB Disk</b> ". If the <b>Check PVR File System</b> has a " <b>SUCCESS</b> " it will show " <b>Pass</b> ".	
<b>Format</b>	Press the <b>OK</b> button, a <b>File System Size</b> menu will pop-up. Press the <b>◀▶</b> buttons to select your preferred file type between <b>FAT32</b> and <b>HiSpeed FS</b> . If you select <b>HiSpeed FS</b> , press the <b>▼</b> button and then press the <b>◀▶</b> buttons to select your preferred file size. Press the <b>OK</b> button to confirm and then press the <b>◀</b> button to start formatting.	
<b>Time Shift Size</b>	After formatting the Time Shift Size menu will appear if you have selected <b>HiSpeed FS</b> in <b>PVR File System Type</b> . Press the <b>◀▶</b> buttons to select your preferred file size. Press the <b>OK</b> button to confirm. This option cannot be chosen if you have selected <b>FAT32</b> in <b>PVR File System Type</b> .	
<b>Speed</b>	This shows you the transfer rate of your USB storage device.	
<b>Free Record Limit</b>	Press the <b>◀▶</b> buttons to set the recording time limit from 1-4 hours.	

## CEC (Consumer Electronics Control)

Allows you to command and control two or more CEC-enabled devices, that are connected through HDMI, by using only one of the TV remote controls (e.g. controlling a TV set, set-top box and DVD player using only the remote control of the TV). CEC also allows individual CEC-enabled devices to command and control each other without user intervention.

Make sure that your CEC compliant device is connected to your TV using a HDMI cable and the correct HDMI input source is selected prior to using this function. (Some HDMI cables may not support HDMI-CEC functions.)

1. Press the **MENU** button and then press the **▲▼** buttons to select the **OPTION** menu and then press the **OK** button.



2. Press the **▲▼** buttons to select **CEC** and then press the **OK** button to select **On / Off**.
3. Press the **BACK** button to return to the previous menu or press the **MENU** button to return to the main menu.
4. Press the **EXIT** button to exit the menu.



- This unit can only communicate with HDMI-CEC compatible devices.
- To be sure that the HDMI-CEC device has this feature, check to see if there is HDMI-CEC compatible logo on it.
- Some HDMI-CEC compliant devices may not support this function.
- HDMI-CEC function only works when the AV device supporting CEC is turned on.

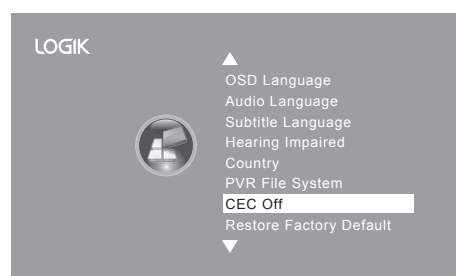

## Restore Factory Default

Restores all settings to the factory defaults.

1. Press the **MENU** button and then press the **▲▼** buttons to select the **OPTION** menu and then press the **OK** button.

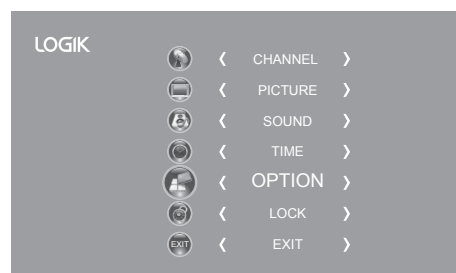

2. Press the **▲▼** buttons to select **Restore Factory Default** and then press the **OK** button.

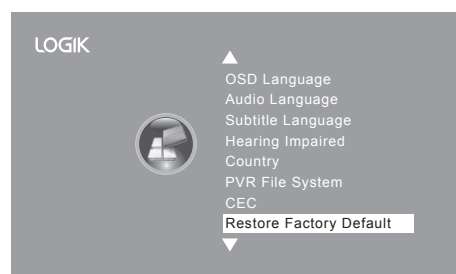

- Press the ◀ button to select "Yes". The TV will turn off and restart after a few seconds.  
Press the ▶ button to select "No" to cancel and return to the main menu.



All channel and user settings will be lost and the TV will revert to "First Time Installation".

## Lock Setting

To access the **LOCK** menu, you must enter the password. Enter the default password "6666" for first time use. To change the password, refer to "Change Password" (see below).

### Lock System

The Lock System is designed to prevent accidental retuning of the TV / losing channels and prevent children watching unsuitable programmes.

The Lock System must be set to On for this function to operate. If the Lock System is set to On, a valid password must be entered when you access Auto Tuning / Manual Tuning / Restore Factory Default.

- Press the **MENU** button and then press the ▲▼ buttons to select the **LOCK** menu and then press the **OK** button.



- Press the **OK** button to select **Lock System**.

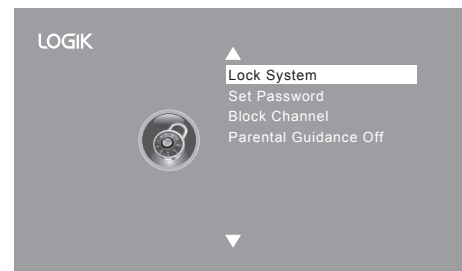

- Use the 0-9 buttons to input a 4-digit password to enter the **LOCK** menu.



The default password is "6666".  
If you change the password, be sure to remember the new password! If you forget the new password, enter the master password "9527".

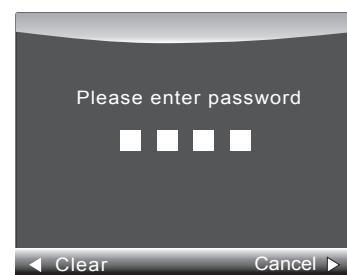

- Press the ▲▼ buttons to select **Lock System** and then the **OK** buttons to select **On / Off**.  
If the Lock System is set to On, a valid password must be entered when you access Auto Tuning / Manual Tuning / Restore Factory Default.
- Press the **BACK** button to return to the previous menu or press the **MENU** button to return to the main menu.
- Press the **EXIT** button to exit the menu.

## Set Password

1. Press the **MENU** button and then press the **▲▼** buttons to select the **LOCK** menu and then press the **OK** button.

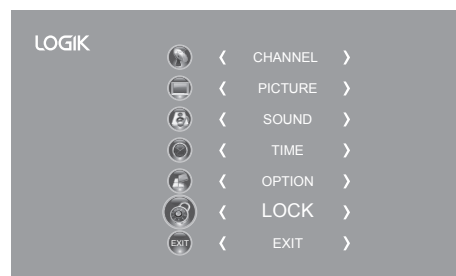

2. Press the **OK** button to select **Lock System**.

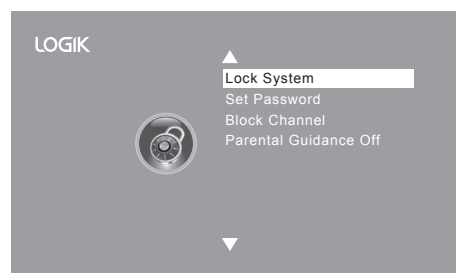

3. Use the **0-9** buttons to input a 4-digit password to enter the **LOCK** menu.



The default password is "6666".  
If you change the password, be sure to remember the new password! If you forget the new password, enter the master password "9527".

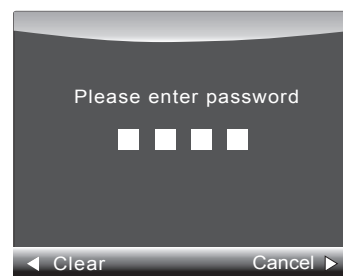

4. Press the **▲▼** buttons to select **Set Password** and then press the **OK** button.

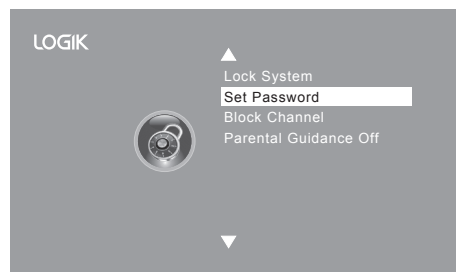

5. Use the **0-9** buttons to input the old password and then input the new 4-digit password. Re-enter new password for confirmation.



The default password is "6666".  
If you change the password, be sure to remember the new password! If you forget the new password, enter the master password "9527".

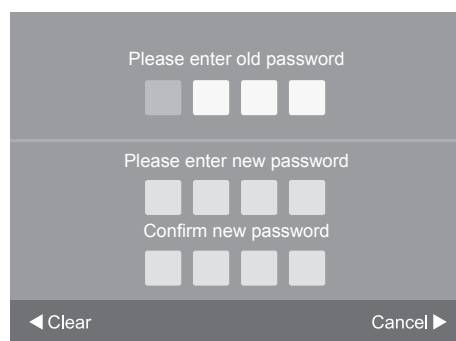

6. Press the **▶** button to return to the previous menu. Press the **MENU** button to return to the main menu.

7. Press the **EXIT** button to exit the menu.

## Block Channel

Block Channel is designed to prevent children watching unsuitable programmes.

When a channel is blocked, a valid password must be entered.

1. Press the **MENU** button and then press the **▲▼** buttons to select the **LOCK** menu and then press the **OK** button.



2. Press the **OK** button to select **Lock System**.

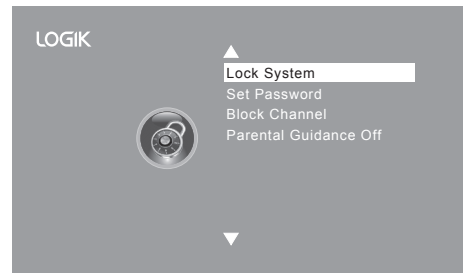

3. Use the **0-9** buttons to input a 4-digit password to enter the **LOCK** menu.



The default password is "6666".  
If you change the password, be sure to remember the new password! If you forget the new password, enter the master password "9527".

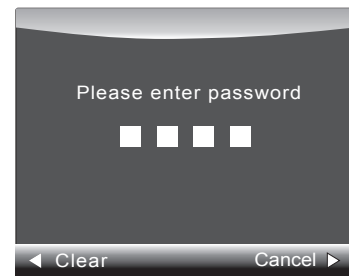

4. Press the **▲▼** buttons to select **Block Channel** and then press the **OK** button.

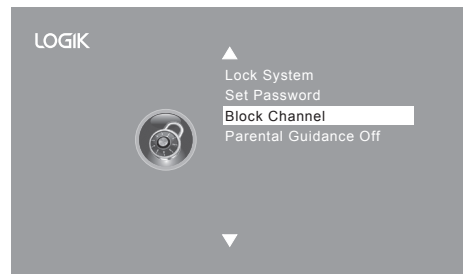

5. A Block Channel screen will pop up. Press the **▲▼** buttons to select a channel. Press the **GREEN** button on the remote control to block or unblock the channel. Press the **GREEN** button again to unblock.

6. Press the **MENU** button once to return to the previous menu. Press the **MENU** button again to return to the main menu.

7. Press the **EXIT** button to exit the menu.

Block Channel		
800 SZTVM01	DTV	
800 SZTVM02	DTV	
800 SZTVM03	DTV	
800 SZTVM04	DTV	
804 Date	DTV	
1C-51	ATV	
2C-53	ATV	
3C-61	ATV	
<div style="text-align: center;"> <small>OK</small>      <small>MENU</small> </div>		

## Parental Guidance

This function allows you to set up blocking schemes to block specific channels and ratings. It operates according to information from the broadcasting station, therefore if the signal has incorrect information, this function will not operate. This allows you to set up blocking schemes to block specific channels and ratings.

This TV is programmed to remember which option it was last set to even if you switch the TV off.

When a programme is locked or rated with delayed state, a valid password must be entered.

1. Press the **MENU** button and then press the **▲▼** buttons to select the **LOCK** menu and then press the **OK** button.



2. Press the **OK** button to select **Lock System**.

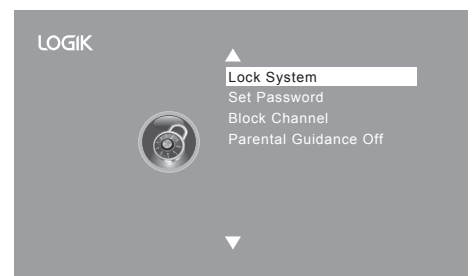

3. Use the **0-9** buttons to input a 4-digit password to enter the **LOCK** menu.



The default password is "6666".  
If you change the password, be sure to remember the new password! If you forget the new password, enter the master password "9527".

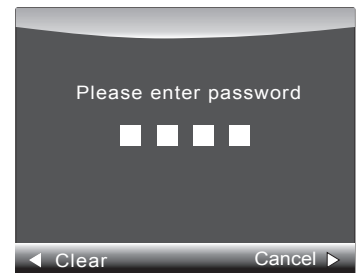

4. Press the **▲▼** buttons to select **Parental Guidance** and then press the **OK** button.

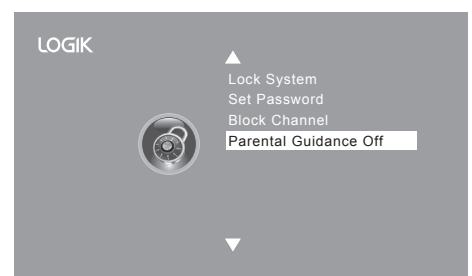

5. Press the **▲▼** buttons to select an age rating: Off, 4-18. Then press the **OK** button to confirm.
6. Press the **BACK** button to return to the previous menu or press the **MENU** button to return to the main menu.
7. Press the **EXIT** button to exit the menu.

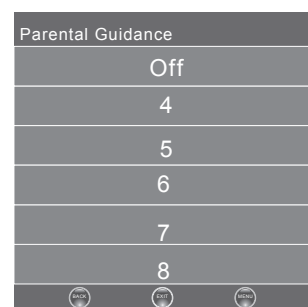

# EPG (Electronic Programme Guide) (DTV Mode)

This system has an Electronic Programme Guide (EPG) to help you navigate through all the possible viewing options.

The EPG supplies information such as programme listings, start and end times for all available services. In addition, detailed information about the programme is often available in the EPG (the availability and amount of programme information will vary, depending on the particular broadcaster).

This function can be used only when the EPG information is broadcast by broadcasting companies.

The EPG displays the programme details for the next 7 days.

## Switch On / Off EPG

1. Press the **GUIDE** button to switch on EPG.
2. Press the **GUIDE** button or the **EXIT** button again to switch off EPG and return to normal TV viewing.

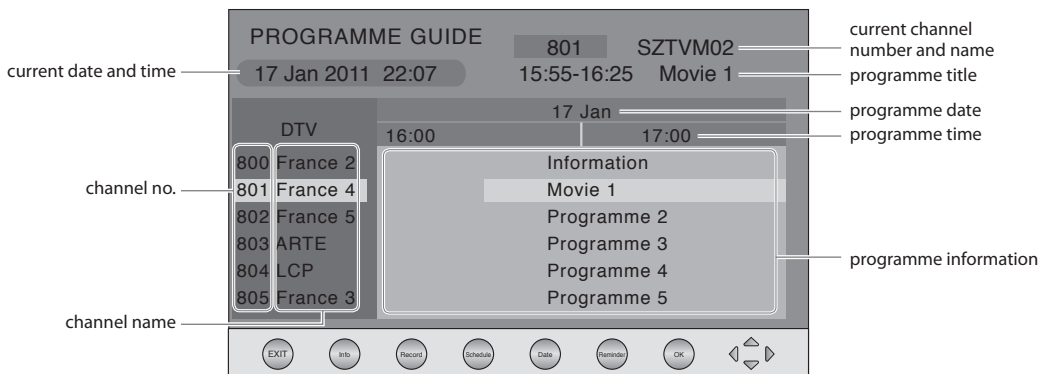

GB

Using the Features

## Select a Programme

Press the **▲▼** buttons to select the desired channel and then press the **◀▶** buttons to select the desired programme. Press the **OK** button to confirm.

## Button Functions in a 7 Days Guide

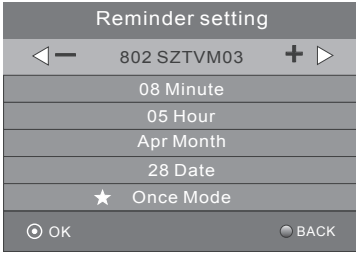
Remote Control Button	Function
<b>RED</b> (Record)	<ul style="list-style-type: none"> <li>• <b>Timer Programming</b> See page 48 for details on <b>Timer Programming</b>.</li> <li>• Press the <b>RED</b> button in the <b>Schedule list</b> to delete the selected preset reminder.</li> </ul>
<b>GREEN</b> (Schedule)	<p>Press the <b>GREEN</b> button to view the preset reminders or scheduled recordings in the <b>Schedule list</b>. Press the <b>GREEN</b> button again to return to the EPG.</p> 
<b>YELLOW</b> (Date)	<p>Press the <b>YELLOW</b> button and then press the <b>◀▶</b> buttons to view the schedule of the previous / next day. Press the <b>YELLOW</b> button again to return to the EPG.</p>
<b>BLUE</b> (Remind)	<p>Press the <b>BLUE</b> button while on the selected programme, the <b>Reminder setting</b> menu will be displayed. Press the <b>▲◀▶▼</b> buttons to adjust the settings and then press the <b>OK</b> button to confirm the settings. After confirmation, the <b>Schedule list</b> will then be displayed with your preset reminders shown. Press the <b>GREEN</b> button to return to the EPG. The TV will automatically tune to the selected programme when it starts.</p> 
<b>i</b>	Press to display detailed information of the selected programme (if available).
<b>▲ or ▼</b>	Press to select a channel.
<b>◀ or ▶</b>	Press to select a programme.
<b>OK</b>	Press to confirm and view the selected channel.
<b>GUIDE / EXIT</b>	Press to switch off the EPG.

## Teletext (ATV Mode)

---

Teletext is a free service broadcast by some TV stations which gives up-to-the-minute information on news, weather, television programmes, share prices and many other topics. Using the Teletext control buttons you can view pages of information that are listed in the teletext index.

### To Turn on Teletext Function



Make sure the TV channel you are watching transmits teletext.  
"No Teletext" sign will show on the screen if teletext is not available.

In ATV mode, press the **TEXT** button to enter Teletext mode. Press the **INDEX** button to display the index page.

Press the **TEXT** button once to exit and the TV will return to the channel you were watching.

### To select a page of text

---

Find the number of the page in the index and enter it using the **0-9** buttons. The number of the page will appear on the top left corner of the screen.

The page counter will search for your page. When it finds it, the page will be displayed.

To move to the next page of text, press the **CH +** button.

To move to the previous page, press the **CH -** button.

To return to the index page, press the **INDEX** button.

### Mix

---

Press the **TEXT** button to display the teletext page and then press the **MIX** button. The text will be superimposed over the TV programme.

Press the **MIX** button again to return to the text page.

### Double height text

---

If you have difficulty reading the text on the TV you can double the height of the text.

Press the **SIZE** button. The top half of the page will be displayed in double height text.

Press the **SIZE** button again. The bottom half of the page will be displayed in double height text.

Press the **SIZE** button again to return to the full page.

### Page STOP

---

If the page of text you have selected contains subpages, these subpages will automatically be displayed in order with a delay to allow you to have enough time to read the page.

Press the **HOLD** button. "

" will appear on the top left corner of the screen.

While the page is on-hold, press the **◀▶** buttons to scroll through the subpages in your own time.

Alternatively, press the **SUBPAGE** button, use the colour buttons to scroll through the subpages.

### To Reveal Information

---

Press the **REVEAL** button to reveal concealed information (quiz answers etc.).

Press the **REVEAL** button again to conceal the information again.

### Fasttext

---

At the bottom of the teletext screen is a row of subject headings in red, green, yellow and blue.

The remote control has a row of colour buttons corresponding to the row of coloured subjects on the screen.

Pressing one of the colour buttons will take you directly to the page corresponding to the subject heading.

## Digital Teletext (DTV Mode)

Digital teletext can access special digital teletext services and specific services which broadcast digital teletext. You will need to turn off **Subtitle Function** before using teletext (refer to page 32 for details).

### Teletext within Digital Service

1. In DTV mode, press the **LIST** button to display the Channel List. Press the **▲▼** buttons and then press the **OK** button to select the teletext channel. Press the **LIST** button to exit the Channel List and the teletext page will be displayed after a few seconds.



#### Alternative

Press the **TEXT** button while watching some programmes to reveal the teletext page (MHEG).

2. Follow the instructions on digital teletext and move onto the next step by pressing **OK**, **▲◀▶▼**, **RED**, **GREEN**, **YELLOW**, **BLUE** or **0-9** buttons etc.
3. To change digital teletext service, select a different service by pressing the **0-9** buttons.



GB

Using the Features

## Connecting a USB Storage Device

1. Switch off the TV before connecting any USB storage device.
2. Connect your USB storage device to the USB port of your TV.
3. Plug the connected devices into the mains socket before switching on the TV.
4. Press the **Power** button on the right side panel of the TV or on the remote control to turn on your TV and your USB storage device.
5. Press the **Source** button on the right side panel of the TV or the **INPUT** button on the remote control to display the Source List. Use the **Up/Down** buttons to select **USB** and then press the **OK** button to confirm.

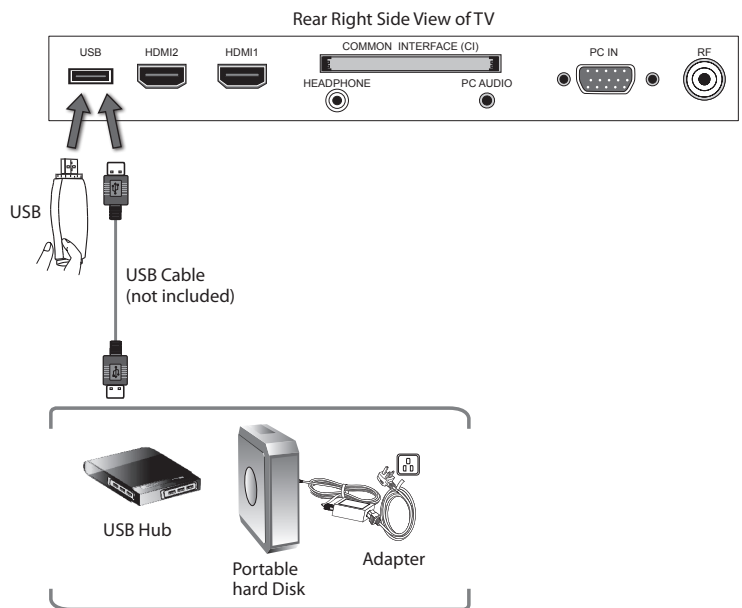

- If a hard disk is used, make sure its mains adapter is connected to the mains supply.
- If a USB hub is used, make sure its mains adapter is connected to the mains supply as the total current consumption may exceed 500mA.
- The maximum supported storage space of the hard disk is 1 TB.
- The file system only supports FAT32 format.
- If you want to store the video streaming of a DTV programme, the transfer rate of the USB storage device must not be less than 5MB/s, otherwise the picture and sound of the programme will be affected and a warning statement will be shown on the screen. If this happens, please upgrade your USB storage device.
- The TV screen will be blank temporarily as it will take time to start up and stabilise the connected hard disk. This is normal and the starting time may vary depending on the brand and the memory size of the connected hard disk.
- Disconnect the USB storage device if it is not in use.

## Viewing Photos

1. Press the **Source** button on the right side panel of the TV or the **INPUT** button on the remote control then press the **Up/Down** buttons to select the **USB** mode and then press the **OK** button.
2. Press the **Left/Right** buttons to select **PHOTO** and then press the **OK** button.
3. Press the **Left/Right** buttons to select your storage device and then press the **OK** button.

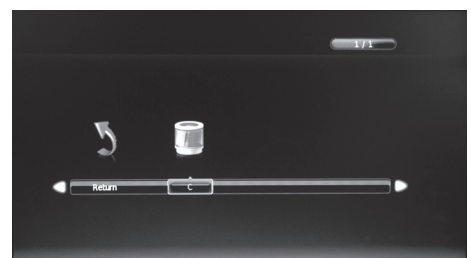
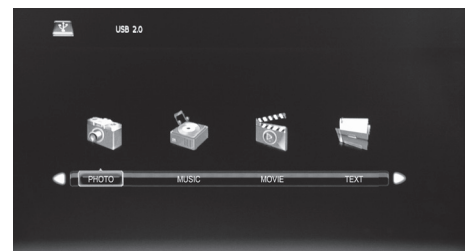

- Press the ▲◀▶▼ buttons to navigate in the picture folder and then press the **OK** button.

If you want to select the specified photos, press the ▲◀▶▼ buttons to select the picture file and then press the **OK** button. A tick box will be displayed. If you want to delete the file, press the **RED** button to enter the **Sub Menu** and then press the ◀ button to confirm.



File format supported: JPG.

- Press the ▶ **PLAY** button to view.
- Press the **OK** button or the **i** button to display the function bar. Press the ◀▶ buttons and then press the **OK** button to select the function: Pause / Prev. / Next / Stop / Repeat (Repeat All / Repeat Off / Repeat 1) / Music / Playlist / Info / Rotate clockwise / Rotate anti-clockwise / Zoom In / Zoom Out / Move View.



If this folder also contains music files, you can select a music track to play at the same time you view your photos.

- Press the **EXIT** button to return to the previous menu.

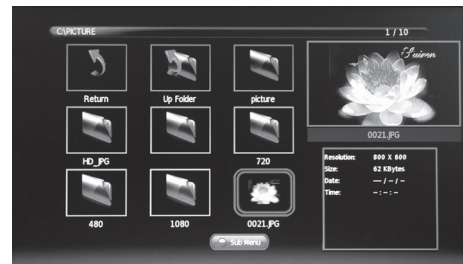

## Listening to Music

- Press the ⏪ button on the right side panel of the TV or the **INPUT** button on the remote control then press the ▲▼ buttons to select the **USB** mode and then press the **OK** button.
- Press the ◀▶ buttons to select **MUSIC** and then press the **OK** button.
- Press the ◀▶ buttons to select your storage device and then press the **OK** button.

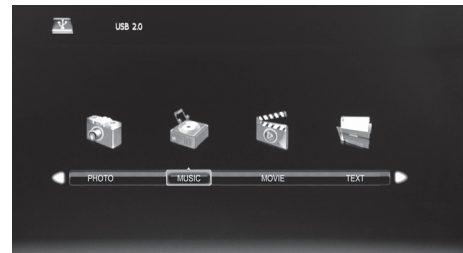

- Press the ◀▶ buttons to select your storage device and then press the **OK** button.
- Press the ▲◀▶▼ buttons to navigate in the music folder and then press the **OK** button.

If you want to select the specified music, press the ▲◀▶▼ buttons to select the music file and then press the **OK** button. A tick box will be displayed. If you want to delete the file, press the **RED** button to enter the **Sub Menu** and then press the ◀ button to confirm.



- Some audio file formats will not be supported.
- Supported file formats: mp3 / wma.

- Press the ▶ **PLAY** button to start to play.

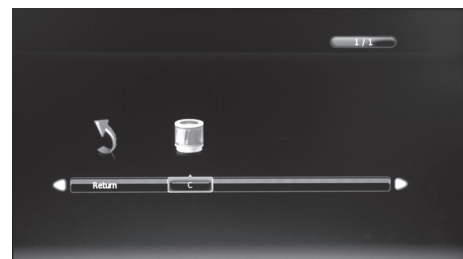

6. Select the music you want to play, it will show the music information (Album / Title / Bit Rate / Artist / Sampling / Year / Size). Then press the **▶** **PLAY** button to play.
7. Press the **▲▼** buttons and then press the **OK** button to select the function: Pause / FB / FF / Prev / Next / Stop / Repeat All / Playlist / Goto Time.
8. Press the **EXIT** button to return to the previous menu.



## Viewing Movies

1. Press the **INPUT** button on the right side panel of the TV or the **INPUT** button on the remote control then press the **▲▼** buttons to select the **USB** mode and then press the **OK** button.
2. Press the **◀▶** buttons to select **MOVIE** and then press the **OK** button.
3. Press the **◀▶** buttons to select your storage device and then press the **OK** button.

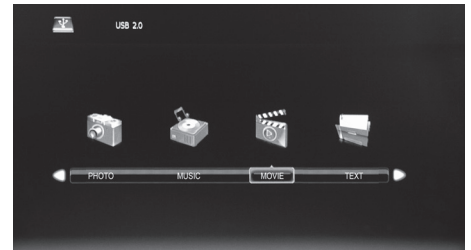

4. Press the **▲◀▶▼** buttons to navigate in the movie folder and then press the **OK** button.

If you want to select the specified movie, press the **▲◀▶▼** buttons to select the movie file and then press the **OK** button. A tick box will be displayed. If you want to delete the file, press the **RED** button to enter the **Sub Menu** and then press the **◀** button to confirm.



- Some audio file formats will not be supported.
- Supported file formats: MPEG1/2.



5. Press the **▶** **PLAY** button to view.
6. Press the **OK** button or the **i** button to display the function bar. Press the **◀▶** buttons and then press the **OK** button to select the function: Pause / FB / FF / Prev / Next / Stop / Repeat (Repeat All / Repeat Off / Repeat 1) / Set A / Playlist / Info / Aspect Ratio.



7. Press the **EXIT** button to return to the previous menu.



## My Text

1. Press the **INPUT** button on the right side panel of the TV or the **INPUT** button on the remote control then press the **▲▼** buttons to select the **USB** mode and then press the **OK** button.
2. Press the **◀▶** buttons to select **TEXT** and then press the **OK** button.

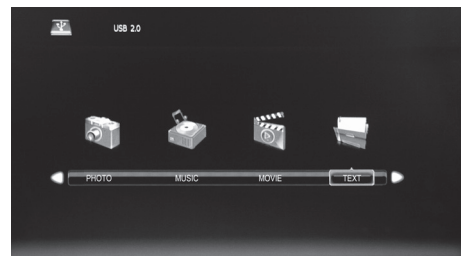

3. Press the **◀▶** buttons to select your storage device and then press the **OK** button.

4. Press the **▲◀▶▼** buttons to navigate in the text folder and then press the **OK** button.

If you want to select the specified text file, press the **▲◀▶▼** buttons to select the text file and then press the **OK** button. A tick box will be displayed. If you want to delete the file, press the **RED** button to enter the **Sub Menu** and then press the **◀** button to confirm.

5. Press the **▶** **PLAY** button to view.



6. Press the **OK** button or the **i** button to display the function bar. Press the **◀▶** buttons and then press the **OK** button to select the function: Prev. page / Next page / Prev. / Next / Stop / Music / Playlist / Info.



If this folder also contains music files, you can select a music track to play at the same time you view your photos.



7. Press the **EXIT** button to return to the previous menu.

## Time Shift Function

This function allows the TV to virtually record the live viewing broadcast programme.



- Time Shift Mode and Recording functions may not work if the signal strength is weak.
- Stop the time-shift function before switching to another input source.



If the transfer rate of the USB storage device is too slow for recording or time shift function, a warning statement will be shown on the screen. If this happens, please upgrade your USB storage device. The minimum transfer speed is 5MB/s.

During normal TV viewing, you may press the **||** button to virtually pause the live viewing broadcast programme if you want to go out for a while (e.g. going to the bathroom / kitchen). When you have returned, press the **▶ PLAY** button to play the missed broadcast programme. The PVR Time Shift progress bar will be displayed on the screen.

There may be a few seconds delay in video and sound when the unit starts to playback the missed broadcast programme. It will return to normal.

GB

PVR (Personal Video Recorder)



### The 'PVR Time Shift Progress Bar'

- 1 Indicates the status of the currently displayed video (▶ / || / ◀◀ / ▶▶)
- 2 Indicates the time lagging behind the live broadcast (DVR reviewing)
- 3 Indicates the available recording time on your USB storage device
- 4 Indicates the current time

### Using the Remote Control

You can shift playback to any point of the virtually recorded programme.

◀◀ or ▶▶	<p>When playing,</p> <ul style="list-style-type: none"> <li>• Press the ◀◀ button repeatedly to speed up ◀◀ x 2 / x 4 / x 8 / x 16.</li> <li>• Press the ▶▶ button repeatedly to speed up ▶▶ x 2 / x 4 / x 8 / x 16.</li> <li>• During fast forward / fast backward state, press the <b>▶ PLAY</b> button to return to normal playback.</li> </ul>
◀◀◀ or ▶▶▶	<ul style="list-style-type: none"> <li>• Press the ▶▶▶ button to jump about 10% forward.</li> <li>• Press the ◀◀◀ button to jump about 10% back.</li> </ul>
▶ PLAY or	<ul style="list-style-type: none"> <li>• During playback, press the    button to display a still screen and then press the <b>▶ PLAY</b> button again to resume playback.</li> <li>• During fast forward / fast backward state, press the <b>▶ PLAY</b> button to return to normal playback.</li> </ul>
■	<p>If you want to exit the PVR Time Shift progress bar and return to the current live broadcast, press the <b>■</b> button.</p>

## Recording DTV Programme onto a USB Storage Device

Use this function to record the DTV programme you are watching on the main screen and save it for future viewing.

The recording from timer programme or direct recording may have a little bit of delay when it starts to record the broadcast programme.

Please make sure the USB device is inserted. If not, a warning message will pop up.

1. Press the **REC** button to record the programme that you are currently watching.
2. Press the **REC** button again, the recording progress bar will disappear.
3. Press the **Stop** button to stop recording.



Recording will stop automatically when the disk is full.



If you want to turn off your TV during recording, press the **Power** button. A dialogue will display.

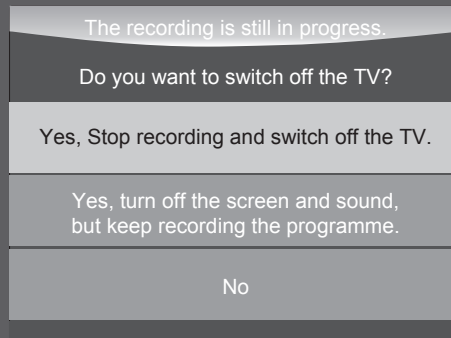

Press the **▲▼** buttons to select your desired option and then press the **OK** button to confirm.

If you select the middle option in the box, the screen will turn off but the recording will still in progress, the LED indicator will alternatively flash red and blue.

# Timer Programming

This function is used to perform scheduled recording.

The recording from timer programme or direct recording may have a little bit of delay when it starts to record the broadcast programme.

Please make sure the USB device is inserted. If not, a warning message will pop up.

1. Press the **GUIDE** button on the remote control. The **EPG** menu will appear.



2. Press the **RED** button on the remote control while on the selected programme, the **RECORDER** menu will be displayed. Press the **▲◀▶▼** buttons to select the settings in the **RECORDER** menu for the Channel, Start time, End time and Mode.

<b>Channel</b>	Press the <b>◀▶</b> buttons to select the channel that you wanted to record.
<b>Start time</b> (for Mode Once, Every Day, Weekly)	Press the <b>▲▼</b> buttons to select the Minutes / Hour / Month / Date and then press the <b>◀▶</b> buttons to adjust the start time.
<b>End time</b> (for Mode Once, Every Day, Weekly)	Press the <b>▲▼</b> buttons to select the Minutes / Hour / Month / Date and then press the <b>◀▶</b> buttons to adjust the end time.
<b>Mode</b>	Press the <b>◀▶</b> buttons to select the Auto / Once / Every Day / Weekly.

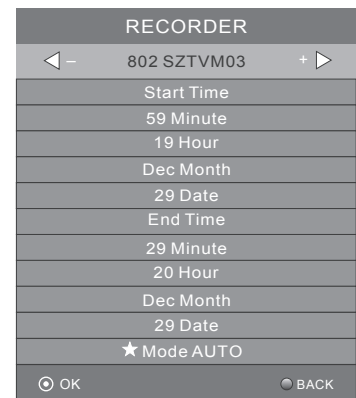

3. After finishing all the recorder adjustments, press the **OK** button to confirm your settings.



- After confirmation, you can press the **GREEN** button to view your scheduled recording in the **Schedule list**.
- If a programme recording starts when the TV is in standby mode, the LED indicator will flash red and blue.

## Play Recorded Programme

You can play a recorded programme from the recorded programme list or from a USB Storage Device.

1. Press the  button on the right side panel of the TV or the **INPUT** button on the remote control and then press the **▲▼** buttons to select the **USB** mode and then press the **OK** button.
2. Press the **◀▶** buttons to select **MOVIE** and then press the **OK** button.
3. Press the **◀▶** buttons to select your storage device and then press the **OK** button.
4. Press the **▲◀▶▼** buttons to select the "MY PVR" folder and then press the **OK** button.
5. Press the **▲◀▶▼** buttons to select your recorded programme and then press the **OK** button. A tick box will be displayed. If you want to delete the file, press the **RED** button to enter the **Sub Menu** and then press the **◀** button to confirm. Press the **▶** **PLAY** button to view.
6. Press the **OK** button or the **i** button to display the function bar.
7. Press the **◀▶** buttons and then press the **OK** button to select the function: Pause / FB / FF / Prev. / Next / Stop / Repeat (Repeat All / Repeat Off / Repeat 1) / Set A / Playlist / Info / Aspect Ratio.
8. Press the **EXIT** button to return to the previous menu.

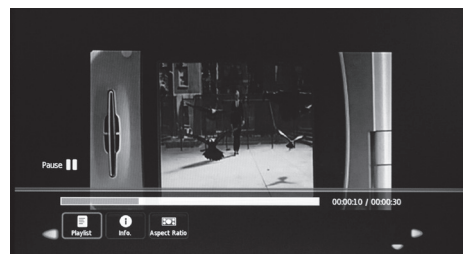
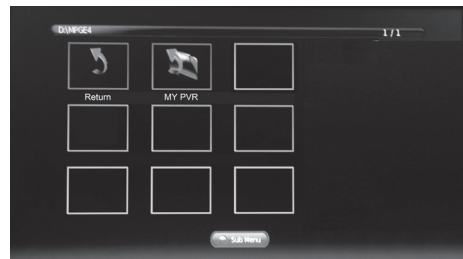
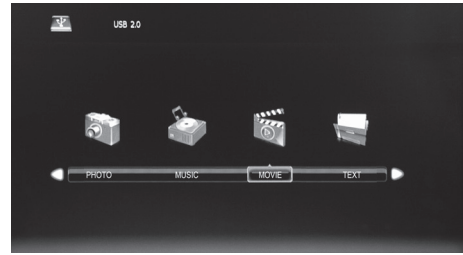

**GB**

PVR (Personal Video Recorder)

## Using the Built-in DVD Player

- L22FED12:** Insert a disc with the label side facing towards the front of the TV.  
**L24FED12:** Insert a disc with the label side facing towards the rear of the TV.  
 (CD-R, CD-RW, DVD-R, DVD-RW, CD, DVD+R, or DVD+RW) Allow 10 seconds for the player to load the disc. If you insert the disc wrongly, an error message will be displayed.
- After the disc is inserted, the TV will change the input source to **DVD** automatically and Smart NAVI will show the content of the disc automatically.
- If the DVD player does not automatically play the disc, press the  button on the right side panel of the TV or the **INPUT** button on the remote control to display the Source List. Use the **▲▼** buttons to select **DVD** and then press the **OK** button to confirm. Press the **▶||** button on the unit or the **▶ PLAY** button on the remote control to start playing.
- Press the **▲** button if you want to remove the disc.



Only insert 12cm discs. Do not insert or play 8cm discs; they will get stuck.

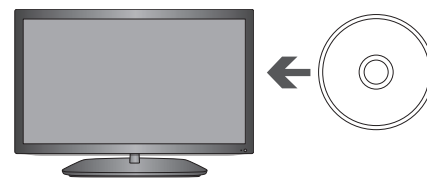

Unable to play disc!

Check label faces front of TV  
 Check disc for marks or damage  
 Check disc is compatible type.







(For L22FED12)

Unable to play disc!

Check label faces rear of TV  
 Check disc for marks or damage  
 Check disc is compatible type.

(For L24FED12)

## Compatible Disc Types

Disc Types	Disc Logo	Recorded Content
DVD-VIDEO (Digital Versatile Disc)		AUDIO + VIDEO
DVD±RW (Audio/Video format or JPEG files)		AUDIO + VIDEO + JPEG
DVD±R (DVD Recordable - Audio/Video format or JPEG files)		AUDIO + VIDEO + JPEG
CD-R (CD Recordable - Audio/Video format or JPEG files)		AUDIO + VIDEO + JPEG
CD-RW (CD-Rewritable - Audio/Video format or JPEG files)		AUDIO + VIDEO + JPEG
AUDIO-CD (Compact Disc Digital Audio)		AUDIO

## Supported Formats

### JPEG

- The file extensions has to be .jpg and not .jpeg.
- Pictures encoding must comply with JPEG/ISO format.
- This DVD player can only display DCF-standard still pictures or JPEG pictures such as TIFF.



Some recorded files may not be played due to the type and format of the disc or condition of the recording.

## Region Code

Both the DVD player and the discs are coded by region. These regional codes must match in order to play the disc. If the codes do not match, the disc will not play.

The Region Number for this DVD player is described on the rear panel of the TV.

Disc Type	DVD-VIDEO
Region code	

## Basic DVD Playback Functions

### Playing the DVD

Depending on the disc, a menu may appear on the TV screen once the disc has loaded. When playing the disc, you may use the **▶||** button on the unit or the **▶ PLAY / ||** buttons on the remote control to toggle between Play and Pause mode. This product also supports Menu / Title / Sequential / Programme Playback.

### Menu Playback (for DVD)

For DVD discs, the screen will display the DVD Disc Menu (Root Menu).

Press the **▶||** button on the unit or the **OK** button or the **▶ PLAY** button on the remote control to start from the highlighted content.

Press the DVD **MENU** button to return to the Root Menu when playing the disc.

For some DVD discs you may need to press the DVD **MENU** button or the **TITLE** button to display the Disc Menu.

### Stopping Playback

Press the **■** button once to stop. Press the **▶||** button on the unit or the **▶ PLAY** button on the remote control to resume from where you stopped.

Press the **■** button twice to stop. Press the **▶||** button on the unit or the **▶ PLAY** button on the remote control to start from the beginning.

In order to protect the disc, press the **■** button and then press the **▲** button to eject the disc. When the disc is ejected, hold the disc edge slightly and remove it from the disc slot.

When not using the DVD function (in stand-by-mode or using others modes for a long period of time), please take out the disc to protect the DVD loader and the disc.

### Previous / Next (for DVD / CD / Multimedia discs)

Press the **◀◀** button to play the last Title / Chapter / Track.

Press the **▶▶** button to play the next Title / Chapter / Track.



If the current track is the first one, pressing the **◀◀** button will restart the disc from the beginning.

For DVD discs, the above functions may vary due to different DVD disc's structure.

### Forward / Backward (for DVD / CD / Multimedia discs)

There are 4 speeds for forward. Press the **▶▶▶▶** button to toggle between the different forward options in sequence. (FORWARD x 2 / FORWARD x 4 / FORWARD x 8 / FORWARD x 16 / Play).

Press the **▶||** button on the unit or the **▶ PLAY** button on the remote control to return to normal speed playback.

For DVD discs, when selecting backward to first title / chapter, the disc will start from the beginning.



There will be no sound during Forward or Backward.

### Pause (for DVD / CD / Multimedia discs)

- For CD / JPEG discs, press the **▶||** button on the unit or the **||** button on the remote control to pause; press the **▶||** button on the unit or the **▶ PLAY** button on the remote control again to resume playback.
- For DVD discs, press the **▶||** button on the unit or the **||** button on the remote control to pause; press the **▶||** button on the unit or the **▶ PLAY** button on the remote control again to resume playback.

### Repeat (for DVD / CD / Multimedia discs)

Press the **REPEAT** button once to display the current repeat mode.

- For CD discs, while playing in sequence, you may use the repeat playback. There are 3 repeat modes, press the **REPEAT** button to toggle between the different repeat modes in sequence. (REPEAT (OFF) / REPEAT (SINGLE) / REPEAT (FOLDER)).
- For DVD discs, you may setup the repeat playback mode. There are 3 repeat modes, press the **REPEAT** button to toggle between the different repeat modes in sequence. (REPEAT (OFF) / REPEAT (CHAPTER) / REPEAT (TITLE)).
- For MP3 / JPEG discs, while playing the disc, you may use the repeat playback. There are 3 repeat modes, press the **REPEAT** button to toggle between the different repeat modes in sequence. (REPEAT (OFF) / REPEAT (SINGLE) / REPEAT (FOLDER)).

## Display (for DVD / Multimedia discs)

Press the **i** button to activate the on screen roll-down menu for the current Title, Chapter, Time and other information.

Press the **i** button repeatedly to turn off the on screen display.

For JPEG discs, press the **i** button once to display first page: Disc type, Track -/- (Current / Full).

Press the **i** button repeatedly to turn off the screen display.

## Goto (for DVD / CD / Multimedia discs)

This function allows you to play your favourite Title / Chapter / Time. Press the **GOTO** button to activate the on screen scroll-down menu for selecting. Input your Title / Chapter / Time by pressing the **0-9** buttons or input the playback time. After editing, press the **OK** button to start. If the input is invalid, it will not function.



For some discs, only **Time** can be selected in the **Goto** function.

## Audio (for DVD / CD)

Press the **AD** button to toggle between different audio modes in sequence.

For CD discs: Stereo / Left / Right / Mix



Some discs may contain multiple languages which can be selected by pressing the **AD** button.

## Repeat A-B (for DVD / CD)

When playing DVD, CD disc, press the **A-B** button to repeat certain content. Press the **A-B** button on the start point (A) and the end point (B) to select the repeat part. Press the **A-B** button a third time to cancel the **A-B** button function and return to normal playback.

## Program (for DVD)

The Program Playback option allows entering the order in which the chapters or tracks will be played, up to a maximum of 12.

Press the **PROG** button to display the **Program** Menu. According to the highlight, input your chapter / title number by pressing the **0-9** buttons and use the **→** button to highlight the **PLAY** item on the screen. Press the **OK** button to confirm. The chapters / title will play in the programmed order. During Program Playback, press the **PROG** button, the programmed order and the contents will be displayed on the screen, and the **Program Playback** will be stopped. To clear the programmed order, use the **←↑↓→** buttons to highlight the **Clear Program** item, then press the **OK** button. To modify the programmed order, use the **←↑↓→** buttons to highlight the modifying item and enter the new chapter / title you want to program directly.

## Playing Multimedia Discs

### MP3 / WMA / JPEG PLAYBACK

When you insert a MP3 / WMA / JPEG disc while in DVD mode the menu on the right will appear.

Press the **←↑↓→** buttons to choose the root directory and then press the **OK** button to enter into the sub directory. Press the **↑↓** buttons to choose the desired track and then press the **OK** button or the **▶||** button on the unit or the **▶ PLAY** button on the remote control to enjoy the music or movie. If you want to return to the upper menu, press the **↑↓** buttons and select **⏪** then press the **OK** button.



	Function
<b>Filter</b>	Select the categories of files displayed in the browser list.
<b>Repeat</b>	Switch between different repeat playing mode.
<b>Mode</b>	Select different playing modes as follows.
<b>Normal</b>	Cancel shuffle mode.
<b>Shuffle</b>	Enable shuffle mode. When playback reaches the end of the current chapter / track, playback jumps to a random chapter / track. As the end of each chapter / track is reached, another random chapter / track will be played until all tracks / chapters have been played or the Shuffle mode is cancelled by toggling to a different Mode Option.

1. In full stop mode, press the **→** button on the remote control to enter the right screen of the navigator.
2. Press the **↑↓** buttons on the remote control to select **Edit mode**, then press the **OK** button on the remote control to highlight the **Edit mode**.
  - To leave the **Edit mode**, press the **OK** button on the remote control again to cancel the highlight.

3. Press the **←** button on the remote control to skip to the left screen. Press the **↑↓** buttons on the remote control to select a file in the preview list, then press the **OK** button on the remote control to tick the file.
  - Press the **OK** button on the remote control again to cancel the tick.
  - Press the **↑↓** buttons on the remote control to select another file and press the **OK** button on the remote control repeatedly to tick more files.

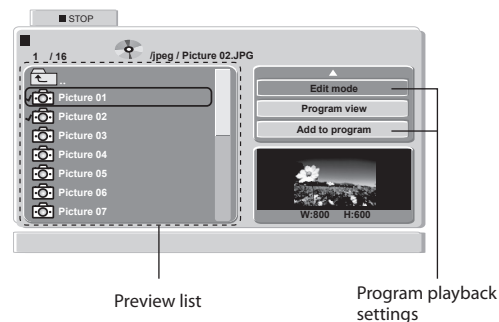

### Adding Files to the Program List

4. Press the **→** button on the remote control to skip to the right screen, then press the **↑↓** buttons on the remote control to select **Add to program** and then press the **OK** button on the remote control to confirm. Now the ticked files have been programmed in the Browser view, you can press the **↑↓** buttons on the remote control to select **Program view** and then press the **OK** button on the remote control to view the ticked files in **Browser view**.
5. Press the **↑↓** buttons on the remote control to select **Edit mode**, then press the **OK** button on the remote control to leave the **Edit mode**.
6. Press the **←** button on the remote control to skip to the left screen. Then press the **↑↓** buttons on the remote control to select a file you want to play from the **Preview list**.
7. Press the **OK** button on the remote control to play the file.

### Deleting Files from the Program List

1. Repeat steps 1 and 2 as described in “Adding files to the Program List” section.
2. Press the ← button on the remote control to skip to the left screen in **Browser view**. Press the ↑↓ buttons on the remote control to select a file you want to delete, and then press the OK button the remote control to tick the file.
3. Press the → button on the remote control to skip to the right screen, then press the ↑↓ buttons on the remote control to select **Clear program** and then press the OK button the remote control to delete the ticked files in **Browser view**.

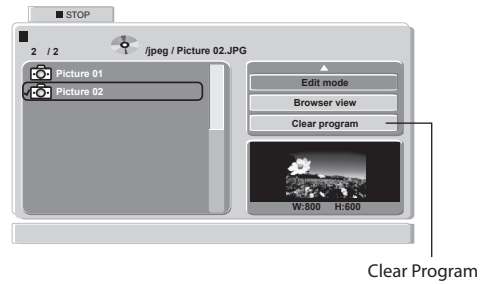

### Returning to the Program List

1. Press the ↑↓ buttons on the remote control to select the **Browser view**, then press the OK button on the remote control to change from **Browser view** to **Program view**.
2. Press the ↑↓ buttons on the remote control to select **Edit mode**, then press the OK button on the remote control to leave the **Edit mode**.

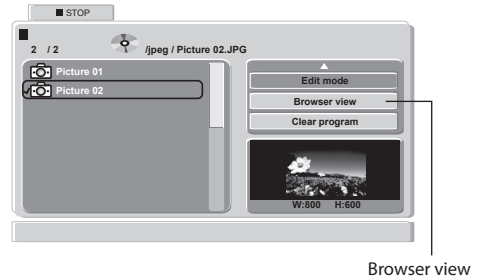

### Picture CD Playback

When you insert a PICTURE CD while in DVD mode the menu on the right will appear.

Press the ←↑↓→ buttons to choose the root directory and then press the OK button to enter into the sub directory. Press the ↑↓ buttons to choose the desired picture and then press the ►|| button on the unit or the OK button or the ► PLAY button on the remote control to enjoy the picture. If you want to return to the upper menu, press the ↑↓ buttons and select [↑] then press the OK button.

### Image Rotation

In picture play state, press the ←↑↓→ buttons to rotate the picture.

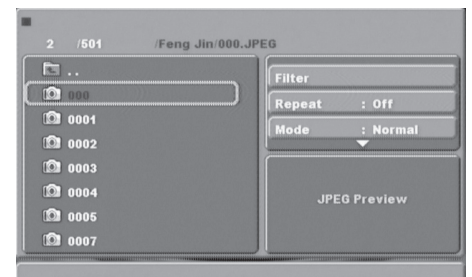

## Using the DVD Language Setup Page

In DVD mode, press the **SETUP** button on the remote control. Press the **↑↓** buttons to select the **Language** menu and then press the **→** button to enter the sub menu. Press the **←↑↓→** buttons to select the menu options. Press the **SETUP** button to exit the menu.



In Setup mode, the disc playback function will not be available.

### OSD Language

Set the OSD language to your language of choice.



Not all DVD discs support multiple OSD Languages.

### Subtitle

Select the subtitle language.



Not all DVD discs support multiple Subtitle Languages.

### Audio

Set the audio language to your language of choice.



Not all DVD discs support multiple Audio Languages.

### DVD Menu

Select the Disc Menu language.



Not all DVD discs support multiple DVD Menu.

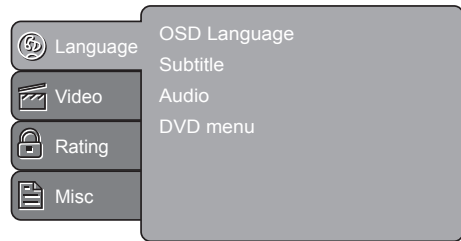

**GB**

Using the DVD Features

## Using the DVD Video Setup Page

In DVD mode, press the **SETUP** button on the remote control. Press the **↑↓** buttons to select the **Video** menu and then press the **→** button to enter the sub menu. Press the **←↑↓→** buttons to select the menu options. Press the **SETUP** button to exit the menu.



In Setup mode, the disc playback function will not be available.

### Aspect Ratio

Selects the aspect ratio.



The image display ratio is related to the recorded disc format. Some discs cannot display images in the aspect ratio you choose. If you play a disc recorded in 4:3 format on a wide screen TV, black bars will appear on the left and right side of the screen. You must adjust the screen setting depending on the type of the television you have.

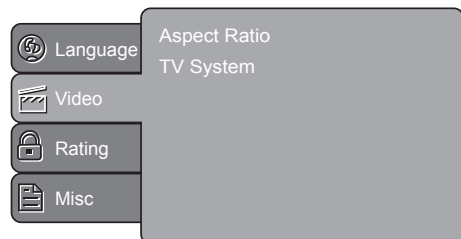

### TV System

You can select from either PAL, NTSC or Auto.



The DVD player setting should be matched to your TV set.

## Using the DVD Rating Setup Page

In DVD mode, press the **SETUP** button on the remote control. Press the **↑↓** buttons to select the **Rating** menu and then press the **→** button to enter the sub menu. Press the **←↑↓→** buttons to select the menu options. Press the **SETUP** button to exit the menu.



In Setup mode, the disc playback function will not be available.

### Parental Control

Set the parental control feature of the player.



Password is needed before setting Parental Control.

### Set the Password

Input four digits(password), then press the **OK** button to confirm.

Select to change the old password to a new password.  
(Factory default is **6666**.)

To change the password, you need to:

1. Input the old password.
2. Input a new 4 digit password.
3. Confirm the password again.

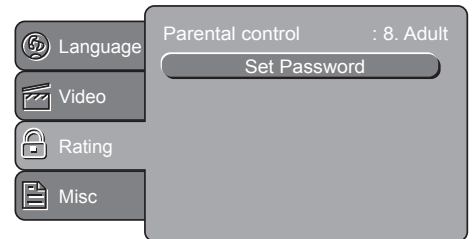

## Using the DVD Misc Setup Page

In DVD mode, press the **SETUP** button on the remote control. Press the **↑↓** buttons to select the **Misc** menu and then press the **→** button to enter the sub menu. Press the **←↑↓→** buttons to select the menu options. Press the **SETUP** button to exit the menu.



In Setup mode, the disc playback function will not be available.

### MISC Setup

- Select **MISC** in the setup menu, and display the submenu.
- Use Default Settings.
- Reset setup data to factory default value.

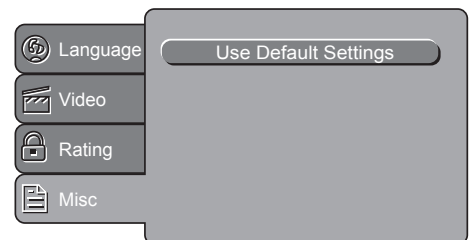

## Maintenance

Careful and regular cleaning can prolong the life of your TV.



Be sure to press the  button at the front right side of the TV or on the remote control to turn off the TV. Disconnect the mains cable from the mains socket before any cleaning.

1. Use a soft dry cloth to wipe away the dust from the screen and surfaces.
2. If the surfaces are extremely dirty, clean the TV with a cloth which has been dipped in a weak soapy water. Wring the cloth until it is almost dry, then use it to wipe the TV.
3. Ensure there is no excess water on the screen. Allow any water or dampness to evaporate before switching the TV on.



Never use alcohol, benzine, paint-thinner, cleaning fluid or other chemicals. Do not use compressed air to remove dust.

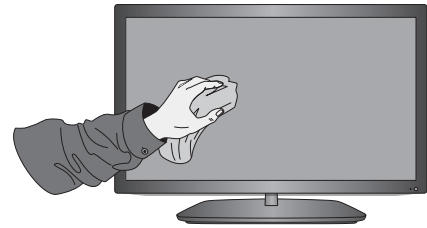

GB

### Handling Discs

- Do not touch the playback side of the disc.
- Do not attach paper or tape to the disc.

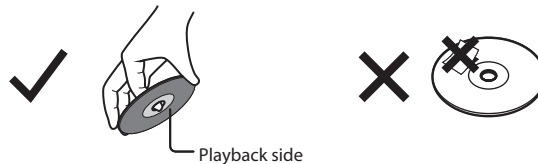

### Cleaning Discs

- Fingerprints and dust on the disc cause picture and sound deterioration. Wipe the disc from the centre outwards with a soft cloth. Always keep the disc clean.

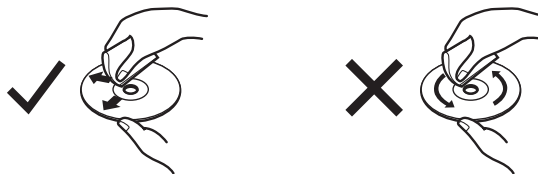

- If you cannot wipe off the dust with a soft cloth, wipe the disc lightly with a slightly moistened soft cloth and finish with a dry cloth.
- Do not use any type of solvent such as thinner, benzine, commercially available cleaners or antistatic spray. They may damage the disc.

### Storing Discs

- Do not store discs in places subjected to direct sunlight or near heat sources.
- Do not store discs in places subjected to moisture and dust such as a bathroom or near a humidifier.
- Storing discs vertically in a case, stacking discs or placing objects on discs outside of their cases may cause warping.

## Hints and Tips

The following table contains various hints and tips to get the best performance from your TV. If you require additional assistance please call our UK Call Centre on **0844 561 1234**. Our UK Customer Contact Centre is open Monday-Saturday 8am-8pm or Sunday 8am-6pm.

The TV does not operate properly.	
<b>The TV does not respond when pressing any buttons</b>	<ul style="list-style-type: none"> <li>The TV may freeze up during use. Disconnect the mains cable from the mains socket for a few minutes. Reconnect the mains cable and try to operate it again as usual.</li> </ul>
<b>TV cannot be switched on</b>	<ul style="list-style-type: none"> <li>Check that the TV is connected to the mains supply.</li> <li>Make sure all connected AV devices are switched off before switching on your TV.</li> </ul>
<b>The remote control does not work</b>	<ul style="list-style-type: none"> <li>Check to see if there are any objects between the TV and the remote control causing an obstruction. Ensure that you are pointing the remote control directly at the TV.</li> <li>Ensure that the batteries are installed with the correct polarity (+ to +, - to -).</li> <li>Install new batteries.</li> </ul>
<b>Power is suddenly turned off</b>	<ul style="list-style-type: none"> <li>Check the power of the TV. The mains supply maybe interrupted.</li> <li>Check if the sleep timer is set.</li> <li>Check whether the Auto Standby is activated.</li> </ul>

The video function does not work.	
<b>No Picture &amp; No Sound</b>	<ul style="list-style-type: none"> <li>Check whether the TV is switched on.</li> <li>Try another channel. The problem may be caused by the broadcaster.</li> </ul>
<b>Picture appears slowly after switching on</b>	<ul style="list-style-type: none"> <li>This is normal, the image is muted during the TV startup process. Please contact your service centre, if the picture has not appeared after five minutes.</li> </ul>
<b>No or poor colour or poor picture</b>	<ul style="list-style-type: none"> <li>Adjust the settings in the <b>PICTURE</b> menu.</li> <li>Try another channel. The problem may be caused by the broadcaster.</li> <li>Check if the video cables are connected properly.</li> </ul>
<b>Horizontal / Vertical bar or picture shaking</b>	<ul style="list-style-type: none"> <li>Check for local interference such as an electrical appliance or power tool.</li> </ul>
<b>Poor reception on some channels</b>	<ul style="list-style-type: none"> <li>Station or cable channel may be experiencing problems, tune to another station.</li> <li>Station signal is weak, reposition the aerial for better reception.</li> <li>Check for sources of possible interference.</li> </ul>
<b>Lines or streaks in pictures</b>	<ul style="list-style-type: none"> <li>Check aerial (Change the position of the aerial.)</li> </ul>
<b>No pictures when connecting HDMI</b>	<ul style="list-style-type: none"> <li>Check if the input source is <b>HDMI1 / HDMI2</b>.</li> </ul>
<b>Picture appears in wrong ratio</b>	<ul style="list-style-type: none"> <li>Adjust the <b>Aspect Ratio</b> settings in the <b>PICTURE</b> menu.</li> </ul>

The audio function does not work.	
<b>Picture OK but no sound</b>	<ul style="list-style-type: none"> <li>Press the <b>VOL + / -</b> buttons.</li> <li>Sound muted? Press the <b>MUTE</b> button.</li> <li>Try another channel. The problem may be caused by the broadcaster.</li> </ul>
<b>No output from one of the speakers</b>	<ul style="list-style-type: none"> <li>Adjust the <b>Balance</b> settings in the <b>SOUND</b> menu.</li> </ul>
<b>Unusual sound from Inside the TV</b>	<ul style="list-style-type: none"> <li>A change in ambient humidity or temperature may result in an unusual noise when the TV is switched on or off and does not indicate a fault with the TV.</li> </ul>
<b>No sound when connecting HDMI</b>	<ul style="list-style-type: none"> <li>Check if the input source is <b>HDMI1 / HDMI2</b>.</li> </ul>
<b>Audio noise</b>	<ul style="list-style-type: none"> <li>Keep the RF coaxial cable away from the other connected cables.</li> </ul>

Password	
<b>Lost password</b>	<ul style="list-style-type: none"> <li>Select the <b>Set Password</b> setting in the <b>LOCK</b> menu, then enter the following master password "<b>9527</b>". The master password clears your previous password and allows you to enter a new password.</li> </ul>

There is a problem in PC mode.	
<b>The signal is out of range (Invalid format)</b>	<ul style="list-style-type: none"> <li>• Adjust the resolution, horizontal frequency, or vertical frequency.</li> </ul>
<b>Vertical bar or stripe on background &amp; Horizontal Noise &amp; Incorrect position</b>	<ul style="list-style-type: none"> <li>• Use Auto configure or adjust clock, phase, or H/V position.</li> </ul>
<b>Screen colour is unstable or shows a single colour</b>	<ul style="list-style-type: none"> <li>• Check the signal cable.</li> <li>• Reinstall the PC video card.</li> </ul>

The DVD function does not work.	
<b>DVD will not read the disc</b>	<ul style="list-style-type: none"> <li>• Check if the disc is correctly inserted.</li> <li>• Check that the disc is clean.</li> <li>• Check if there is any obvious damage to the disc.</li> <li>• Try to play the disc on another DVD to check whether it has content.</li> </ul>
<b>DVD does not have the signal</b>	<ul style="list-style-type: none"> <li>• Check if the TV is in DVD mode.</li> </ul>

FAQs (Frequently Asked Questions)	
<b>Why have I lost some / all of my channels?</b>	<ul style="list-style-type: none"> <li>• It happens sometimes if you have a weak signal. Usually it just means you'll need to rescan your digital box or TV. Don't worry, it's easy to do. And once you've done it, you should get all the Freeview channels available to you. If problems persist you may need to get your aerial checked. Talk to your retailer or contact your local aerial installer.</li> </ul>
<b>Why do I get 'blocking' on my digital picture?</b>	<ul style="list-style-type: none"> <li>• In most cases, blocking is caused by a reception problem – either the signal is too weak or there is some kind of interference. Talk to your retailer or contact your local aerial installer.</li> <li>• Blocking can also be caused by a digital signal that is too strong. If you are still experiencing blocking and the signal is strong, consult your local aerial installer for advice.</li> </ul>
<b>Can I watch Freeview using a portable set-top aerial?</b>	<ul style="list-style-type: none"> <li>• Some, but only a few, homes may be able to use a set top aerial. However, for a much better reception, we strongly recommend that you use a rooftop aerial.</li> <li>• If you do not have access to a rooftop aerial – for example, if you rent a flat and the aerial is the responsibility of your landlord, or if you're using a second TV in the bedroom and don't want the hassle and expense of using extension cables, a set – top aerial may be your only option.</li> </ul>
<b>What type of aerial do I need?</b>	<ul style="list-style-type: none"> <li>• If you are installing a new aerial, we recommend a wideband rooftop aerial rather than a loft aerial. Loft aerials generally receive a weaker digital signal and are more likely to get interference from other electrical devices in the home. We suggest you have an aerial survey done before getting an aerial upgrade.</li> <li>• Talk to your retailer or contact your local aerial installer.</li> </ul>

## Display Modes

The screen resolution has been optimised during production for the display modes listed below.

### YPbPr Mode

Resolution	Vertical Frequency (Hz)	Aspect Ratio
480I: 720 x 480	60	Auto / Smart Zoom / Subtitle / Zoom / 16:9 / 4:3 / Full
480P: 720 x 480		
576I: 720 x 576	50	
576P: 720 x 576		
720P: 1280 x 720	50	
	60	
1080I: 1920 x 1080	50	
	60	
1080P: 1920 x 1080	50	
	60	

### PC Mode

Please check the display settings of your computer before connecting to the TV. If the display setting of your computer does not match the TV, there may be no video.

Resolution	Vertical Frequency (Hz)	Aspect Ratio
640 x 480	60	4:3 / 16:9 / Full
	72	
	75	
800 x 600	60	
	72	
	75	
1024 x 768	60	
	70	
	75	
1360 x 768	60	
1920 x 1080	60	

### HDMI Mode

Resolution	Vertical Frequency (Hz)	Aspect Ratio
480I: 1440 x 480	60	Auto / Smart Zoom / Subtitle / Zoom / 16:9 / 4:3 / Full
480P: 720 x 480	60	
576I: 1440 x 576	50	
576P: 720 x 576	50	
720P: 1280 x 720	50	
	60	
1080I: 1920 x 1080	50	
	60	
1080P: 1920 x 1080	50	
	60	

## Specifications

Model	L22FED12	L24FED12
Panel System	22 inch LED Backlit LCD Panel	24 inch LED Backlit LCD Panel
Display Resolution	1920 pixels (horizontal) x 1080 pixels (vertical)	1920 pixels (horizontal) x 1080 pixels (vertical)
Television System	PAL I / BG / DK SECAM L / BG / DK	PAL I / BG / DK SECAM L / BG / DK
Brightness	200 cd/m <sup>2</sup>	250 cd/m <sup>2</sup>
Contrast Ratio	1000:1	1000:1
Power Source	100-240V~50/60Hz	100-240V~50/60Hz
Energy Efficiency Class	B	B
Screen Size (measured diagonally)	Approx. 54.6 cm (21.5 inch)	Approx. 59.8 cm (23.6 inch)
Power Consumption (In HOME / STANDBY mode)	28.1 W	32.8 W
Average Annual Energy Consumption	41 kWh	46.72 kWh
Standby Power Consumption	0.35 W	0.35 W
Operating Temperature	0°C – 40°C	0°C – 40°C
Operating Humidity	10% – 80%	10% – 80%
Mercury Content (mg)	X	X
Presence of Lead	√	√
Reference Period	2010/1062 – 2011	2010/1062 – 2011
Speaker Power	3 W + 3 W	3 W + 3 W
Dimension( W x D x H) with base	518 x 160 x 363 mm	562 x 160 x 388 mm
Weight (Net)	3.8 kg	4.4 kg
<b>Inputs / Output</b>		
SCART	1	1
HDMI	2	2
PC IN	1	1
PC AUDIO	1	1
YPbPr	1	1
Common Interface	1	1
AV	1	1
USB	1	1
ADUIO IN (RCA)	1 (L + R)	1 (L + R)
Aerial	1	1
Headphone (3.5mm)	1	1

Features and specifications are subject to change without prior notice.

**GB**

Maintenance, Hints and Tips, Specification

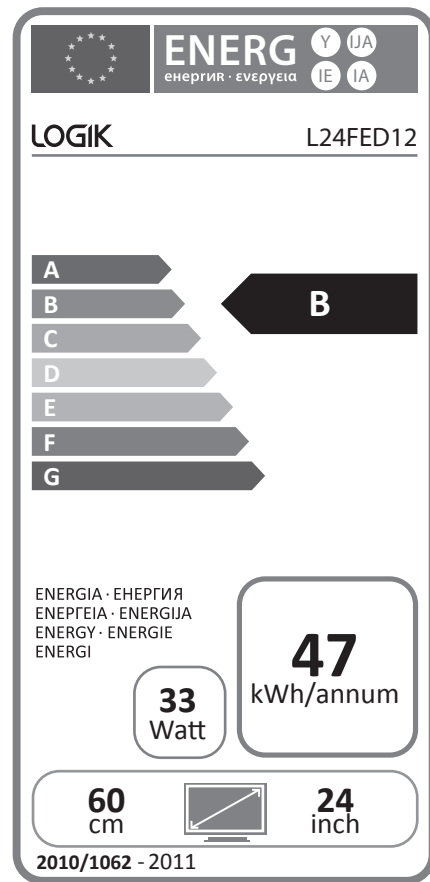
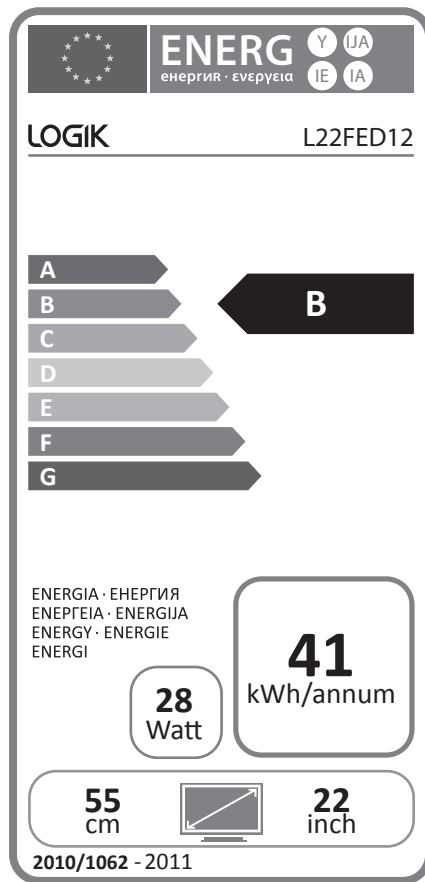

# Safety Warnings

- Read all the instructions carefully before using the unit and keep them for future reference.
- Retain the manual. If you pass the unit onto a third party make sure to include this manual.
- Check that the voltage marked on the rating label matches your mains voltage.

## Damage

- Please inspect the unit for damage after unpacking.
- Do not continue to operate the unit if you are in any doubt about it working normally, or if it is damaged in any way - switch off, withdraw the mains plug and consult your dealer.

## Location of Unit

- The unit must be placed on a flat stable surface and should not be subjected to vibrations.
- Do not place the unit on sloped or unstable surfaces as the unit may fall off or tip over.
- The mains socket must be located near the unit and should be easily accessible.
- This unit is designed for indoor, domestic use only.

## Temperature

- Avoid extreme degrees of temperature, either hot or cold. Place the unit well away from heat sources such as radiators or gas / electric fires.
- Avoid exposure to direct sunlight and other sources of heat.

## Naked Flames

- Never place any type of candle or naked flame on the top of or near the unit.

## Moisture

- To reduce the risk of fire, electric shock or product damage, do not expose this unit to rain, moisture, dripping or splashing. No objects filled with liquids, such as vases, should be placed on the unit.
- If you spill any liquid into the unit, it can cause serious damage. Switch it off at the mains immediately. Withdraw the mains plug and consult your dealer.

## Ventilation

- To prevent the risk of electric shock or fire hazard due to overheating, ensure that curtains and other materials do not obstruct the ventilation vents.
- Do not install or place this unit in a bookcase, built-in cabinet or in another confined space. Ensure the unit is well ventilated.
- Make sure that there is a gap of at least 10 cm on both sides and a gap of 20 cm at the top.

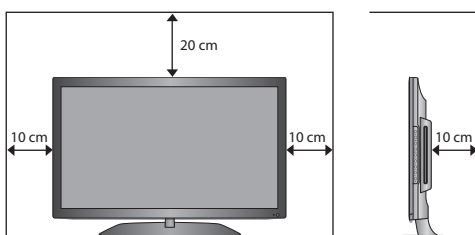

## Safety

- Always disconnect the unit from the mains supply before connecting / disconnecting other devices or moving the unit.
- Unplug the unit from the mains socket during a lightning storm.

## Mains Cable

- Make sure the unit or unit stand is not resting on top of the mains cable, as the weight of the unit may damage the mains cable and create a safety hazard.
- If the mains cable is damaged it must be replaced by the manufacturer, its service agent, or similarly qualified persons in order to avoid a hazard.

## Interference

- Do not place the unit on or near appliances which may cause electromagnetic interference. If you do, it may adversely affect the operating performance of the unit, and cause a distorted picture or sound.

## Optimum viewing

- View the unit in moderate light to prevent eye strain. It is recommended to watch the unit from a distance 3-7 times that of the screen height.

## LCD screen

- The LCD screen is manufactured using high-precision technology. However, some tiny black points and / or bright points (red, blue or green in colour) may constantly appear on the LCD screen. These points are generated in the manufacturing process and are normal.

## Screen Burn

- A characteristic of Plasma and TV Panels is that displaying the same image for a long time may cause a permanent after-image to remain on the screen. This is called screen burn. Most pictures shown on the unit will be constantly moving and fill the screen.
- Examples of images that you need to watch out for are as follows (this is not an all-inclusive list):
  1. **Black Bars:** If black bars appear at the left / right or top / bottom of the screen, it is recommended to change the format so that the picture fills the entire screen.
  2. **TV Channel Logos:** e.g. Shopping channel logos and pricing displays - especially if they are bright and stationary. Moving or low-contrast graphics are less likely to cause ageing of the screen.
  3. **Time Displays**
  4. **Teletext:** Do not view a stationary page for long periods of time.
  5. **TV Menus**
  6. **Pause Mode:** Do not leave the screen in pause mode for long periods of time, e.g. when watching videos.
- To prevent screen burn if viewing any of the above for long periods of time, reduce contrast and brightness when viewing. Once burn-in occurs it will never disappear completely.

### Standby

- The  button on the remote control does not switch off the unit completely. The unit will continue to draw electricity from the mains supply while in standby. In the interests of safety and to avoid unnecessary energy consumption, never leave the unit in standby while unattended for long periods of time, e.g. overnight, while on holiday or while out of the house. Disconnect the mains plug from the mains socket.

### Batteries

- Batteries used in the remote control for this unit are easily swallowed by young children and this is dangerous.
- Keep loose batteries away from young children and make sure that the battery holder tray is secure in the remote control. Seek medical advice if you believe a cell has been swallowed.
- Please dispose of batteries correctly by following the guidance in this manual.
- The batteries shall not be exposed to excessive heat such as sunshine, fire or the like.

### Supervision

- Children should be supervised to ensure that they do not play with the unit and the remote control.
- Never let anyone especially children push anything into the holes, slots or any other openings in the case - this could result in a fatal electric shock.

### DVD

#### Class 1 Laser Product

This unit utilises a laser. Use of controls, adjustments or performance of procedures other than those specified herein may result in hazardous radiation exposure.



- Before moving the unit, ensure the disc tray is empty.
- Always remove the disc when the unit is not in use.
- Failure to do so will risk severely damaging the disc and the unit.
- Do not stack devices, heat from other devices may affect the performance of the unit.



The lightning flash with arrowhead symbol, within an equilateral triangle, is intended to alert the user to the presence of uninsulated "dangerous voltage" within the unit's enclosure that may be of sufficient magnitude to constitute a risk of electric shock.



The exclamation point within an equilateral triangle is intended to alert the user to the presence of important operating and maintenance (servicing) instructions in the manual accompanying the unit.

### Service

- To reduce the risk of electric shock, do not remove screws. The unit does not contain any user-serviceable parts. Please leave all maintenance work to qualified personnel.
- Do not open any fixed covers as this may expose dangerous voltages.

### Maintenance

- Ensure to unplug the unit from the mains socket before cleaning.
- Do not use any type of abrasive pad or abrasive cleaning solutions as these may damage the unit's surface.
- Do not use liquids to clean the unit.
- The wall socket plug is used as a disconnect device, the disconnect device should be readily accessible.
- This equipment is a Class II or double insulated electrical appliance. It has been designed in such a way that it does not require a safety connection to electrical earth.

To prevent the spread of fire, keep candles or other open flames away from this product at all times.

If you require a replacement for any of the items listed below, please quote their corresponding part numbers:

Replacement Part	Part Number
TV Stand Support	115C2461101
TV Base	102C2461113
Remote Control	504C1961101
AAA Batteries	32200007158
Screw A	209100422B1
Screw B	20912223101



Visit [Partmaster.co.uk](http://Partmaster.co.uk) today for the easiest way to buy electrical spares and accessories. With over 1 million spares and accessories available we can deliver direct to your door the very next day. Visit [www.partmaster.co.uk](http://www.partmaster.co.uk) or call 0844 800 3456 (UK customers only). Calls charged at National Rate.



This symbol on the product or in the instructions means that your electrical and electronic equipment should be disposed at the end of its life separately from your household waste. There are separate collection systems for recycling in the EU.

For more information, please contact the local authority or your retailer where you purchased the product.

#### **Rovi Proprietary Rights**

This item incorporates copy protection technology that is protected by U.S. patents and other intellectual property rights of Rovi Corporation. Reverse engineering and disassembly are prohibited.

#### **Restriction on Use & Rovi Trade Mark Rights**

Use of the copyright protection technology contained in this product must be authorised by Rovi Corporation and is intended for home and other limited viewing uses only unless otherwise authorised by Rovi Corporation. The names "Rovi Corporation" and "Macrovision" are protected by trademarks.

#### **Notes for battery disposal**

The batteries used with this product contain chemicals that are harmful to the environment. To preserve our environment, dispose of used batteries according to your local laws or regulations. Do not dispose of batteries with normal household waste.

For more information, please contact the local authority or your retailer where you purchased the product.

HDMI, the HDMI logo and High-Definition Multimedia Interface are trademarks or registered trademarks of HDMI Licensing LLC.

The FREEVIEW word and logo are trademarks of DTV services Ltd and are used under licence. ©DTV Services Ltd 2002

The "HD Ready" logo is a trademark of DIGITALEUROPE.

SRS TruSurround HD™ creates an immersive, feature-rich surround sound experience from two speakers, complete with rich bass, high frequency detail and clear dialogue.

TruSurround HD, SRS and the  symbol are trademarks of SRS Labs, Inc.

All trademarks are the property of their respective owners and all rights are acknowledged.





