

KENWOOD

Free-Standing Double Oven Electric Cooker KDC606B19 / KDC66SS19

installation / instructions manual



Contents

Safety Warnings	4
Unpacking	6
Product Overview	7
Front View	7
Top View.....	7
Control Panel.....	8
Controls.....	8
Touch Control Display.....	9
Setting the Clock	9
Before Using Your Cooker	10
First Time Use of the Hob	10
Choosing the Right Cookware	10
Using Your Hob	11
First Time Use of the Oven	12
Using the Oven	12
Replacing the Anti-tilting Oven Shelf	13
Using the Oven Control	13
Energy Saving	13
Using the Grill/Top Oven	14
Using the Minute Minder Timer	16
Using the Cooking Timer	17
Using the Automatic Cooking Timer	18
Adjusting the Tone of the Timer Alarm	20
Adjusting the Display Brightness	21
General Advice	22
Cleaning the Outside of the Cooker	22
Cleaning the Ceramic Hob	22
Cleaning the Cooker Door Glass	23
Cleaning the Inside of Your Cooker	23
Cleaning the Enamel Parts Inside Your Oven	23
Cleaning the Catalytic liners Inside Your Oven	24
Removing and replacing the catalytic liners	24
Removing the Grill Door	25
Replacing the Oven Lamp	26
Hints and Tips	27

Product Fiche and Specifications	29
Energy Saving Tips and Energy Label	30
- Main Oven	30
- Hob	30
Installation	31
Adjusting the Feet	32
Moving the Cooker	32
Stability Bracket	33
Electrical Connection	34

Safety Warnings

IMPORTANT SAFETY INSTRUCTIONS READ CAREFULLY AND KEEP FOR FUTURE REFERENCE

- It is recommended that this appliance is installed by a qualified electrical engineer. The manufacturer is not responsible for any damage caused by incorrect installation.
- Check whether there is any damage to the appliance after you have unpacked it. If any damage is found, do not use the appliance and contact the store where you purchased it.
- This appliance is for indoor domestic use only.
- This appliance is for cooking purposes only. It must not be used for other purposes, for example room heating.
- For disconnection from the mains supply you must have a switch with a contact separation of at least 3.0 mm in all poles and rated 32 Amp that provides full disconnection, this must be incorporated in the fixed wiring in accordance with the local wiring rules.
- If the mains cable gets damaged, it should be replaced by an authorized service agent or qualified electrician in order to avoid a hazard.
- The oven must be used in a well ventilated location and installed on flat / level ground.
- Only operate your appliance in a dry atmosphere.
- Keep the electrical cables of your other appliances away from hot areas; do not let them touch the appliance.
- Ensure that the appliance is switched off at the mains supply switch and allowed to completely cool down before cleaning, replacing the oven lamp or performing any maintenance to avoid the possibility of an electric shock or burns.
- Use of your appliance creates moisture in the room in which it is placed, make sure that your kitchen is well ventilated. Maintain the natural ventilation ducts properly.
- Cleaning and user maintenance shall not be made by children without supervision.
- To prevent the appliance tipping, the stabilizing bracket must be installed.



- This appliance can be used by children aged from 8 years and above and persons with reduced physical, sensory or mental capabilities or lack of experience and knowledge if they have been given supervision or instruction concerning use of the appliance in a safe way and understand the hazards involved. Cleaning and user maintenance shall not be made by children without supervision.
- Children should be supervised to ensure that they do not play with the appliance.
- During use the appliance becomes hot. Care should be taken to avoid touching the heating elements inside the oven or the hotplates.
- The appliance and its accessible parts become hot during use. Young children should be kept away.
- Unattended cooking on a hob with fat or oil can be dangerous and may result in fire. NEVER try to extinguish a fire with water, but switch off the appliance and then cover the flame e.g. with a lid or a fire blanket.
- Danger of fire: Do not store items on the cooking surfaces.
- When the oven is hot never touch the oven glass or any other parts that get hot. Allow the oven to cool before touching these parts.
- Do not use harsh abrasives cleaners or sharp metal scrapers to clean the oven door glass since they can scratch the surface, which may result in the glass shattering.
- Before starting to use your appliance, keep curtains, tulle, paper or flammable materials away from your appliance. Do not keep combustible or flammable things in or on the appliance.
- Do not use steam cleaners for cleaning the appliance.
- Do not rest any items on or stand on the open door.
- If the hob surface is cracked, switch off the appliance to avoid possibility of electric shock.
- Take care when handling parts with glass, knocks, chips, heavy handling and dropping could cause the glass to shatter.
- The glass oven door uses toughened glass and is designed to break into many 'nugget' size pieces if it breaks. These pieces will still have sharp edges, please handle broken glass with care.
- The appliance is not intended to be operated by means of an external timer or separate remote-control system.

Thank you for purchasing your new Kenwood Free Standing Electric Double Oven.

You must read this manual in order to fully understand how to operate it correctly.

This cooker must be installed by a competent engineer. Please allow the installer to view the installation section of this manual.

Read all the safety instructions carefully before use and keep this manual for future reference.

Unpacking

Remove all packaging from the unit. Retain the packaging. If you dispose of it please do so according to local regulations.

The following items are included:



The Main Unit

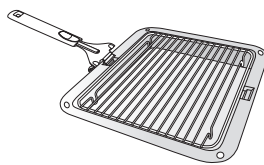

Grill Rack x 1
Grill Pan x 1
Grill Pan Handle x 1



Oven Shelf x 2



Stability Bracket x 1



If items are missing, or damaged please contact Partmaster (UK only).
Tel: 0344 800 3456 for assistance.

* All images are for indication only; please refer to your individual unit for actual item.

Product Overview

Front View

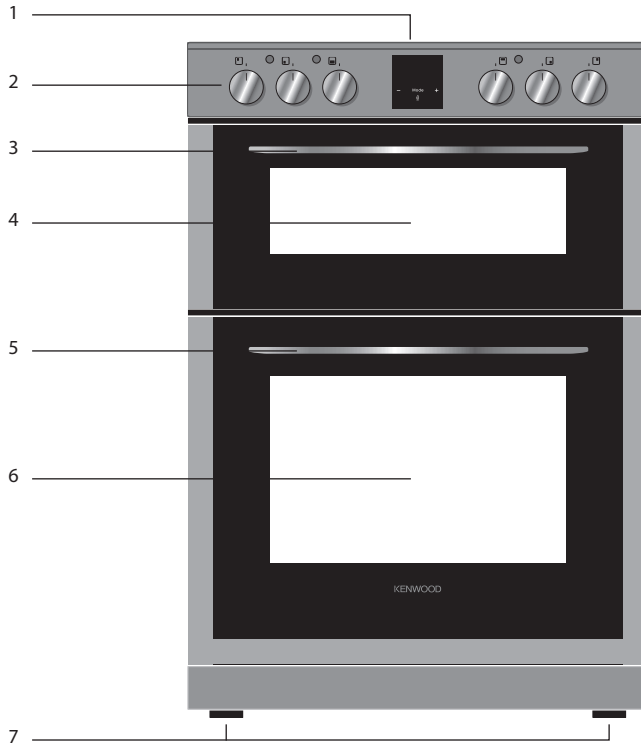

- | | |
|--------------------------------------------|---------------------|
| 1. Ceramic Hob | 5. Oven Door Handle |
| 2. Control Panel and Touch Control Display | 6. Oven Door |
| 3. Top Oven Door Handle | 7. Adjustable Feet |
| 4. Top Oven Door | |

Top View

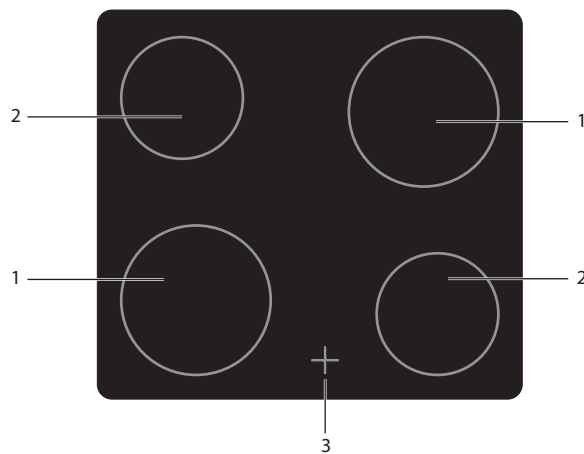

- | | |
|----------------------------|------------------------------|
| 1. Large cooking zone 18cm | 2. Small cooking zone 14.5cm |
| | 3. Hot zone indicators |

* All images are for indication only; please refer to your individual unit for actual item.

Control Panel

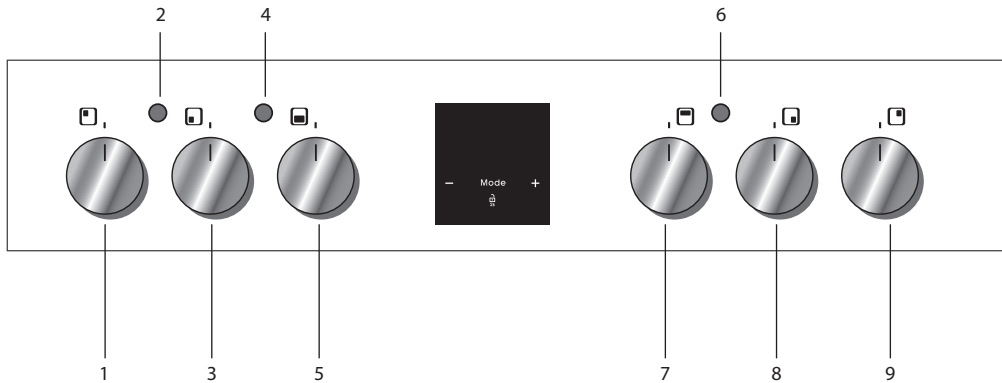

- | | |
|-------------------------------------|----------------------------------|
| 1. Back Left Hob Control | 5. Bottom Oven Control |
| 2. Hob Indicator | 6. Top Oven Thermostat Indicator |
| 3. Front Left Hob Control | 7. Top Oven Control |
| 4. Bottom Oven Thermostat Indicator | 8. Front Right Hob Control |
| | 9. Back Right Hob Control |

Controls

• 0 = OFF

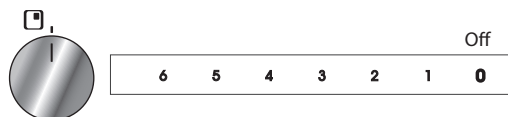
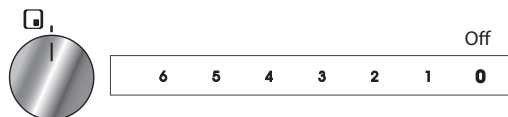
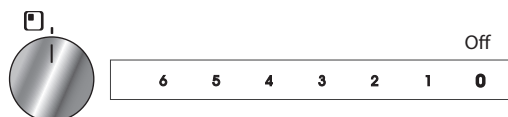
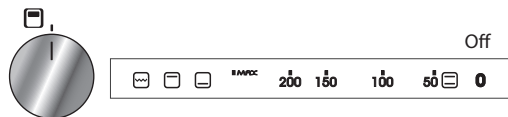
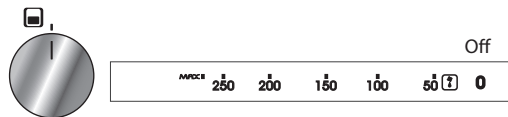

8 * All images are for indication only; please refer to your individual unit for actual item.

Touch Control Display

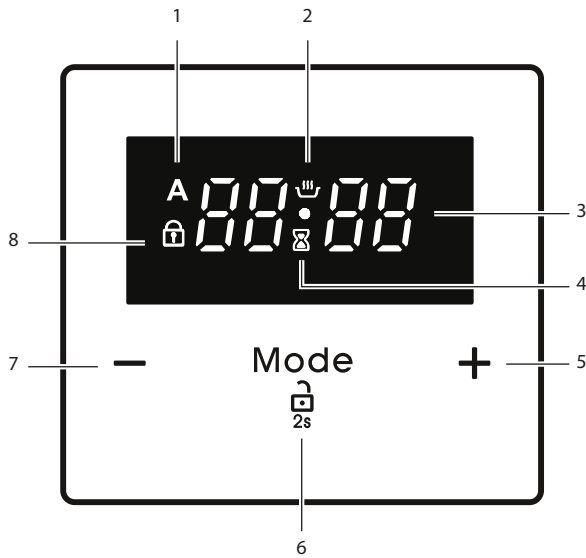

1. **A** - Auto Cooking Symbol
2. Manual Cooking Symbol
3. Clock / Timer Count down
4. - Minute Minder Symbol - Shows a timer is active
5. + control - Press to increase the time
6. Mode - Press to scroll Timer modes or press and hold for 2 seconds to unlock the display
7. - control - Press to decrease the time
8. Symbol - Shows the display is currently locked

Setting the Clock

Before using your new cooker you **must** set the clock to the correct time.

1. When the power is first switched on the clock display will be flashing, the display will show **A** and the time will show as 12:00.
2. Press the '+' and '-' buttons at the same time, the number will stop flashing but the dot will flash and the Manual cooking symbol will appear.
3. While the dot is still flashing press the '+' or '-' buttons to adjust the time. Pressing and holding the buttons will quickly adjust the time.
4. Once you have set the correct time just wait for a few seconds. When the dot stops flashing the time is then set. The Symbol will appear after 30 second.

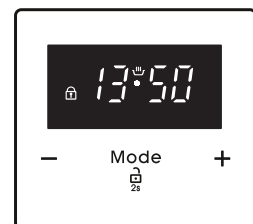
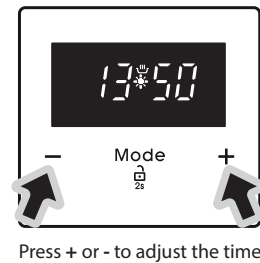
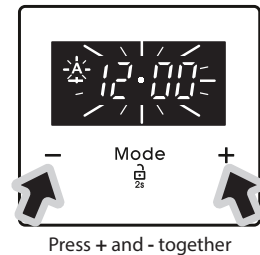

Before Using Your Cooker

Before using your new cooker, please:

- Make sure all the controls are turned off.
- Read this Instruction/Installation Manual, taking special note of the 'Safety Warnings' section.
- Turn the mains power on.

First Time Use of the Hob

Operate your vitro ceramic hobs at level 6 for 5 minutes. This will remove any manufacturing residues there may be a small amount of smoke and a slight odour. This is normal and will stop after a few minutes.

Choosing the Right Cookware

Do not use cookware with jagged edges or a curved base.

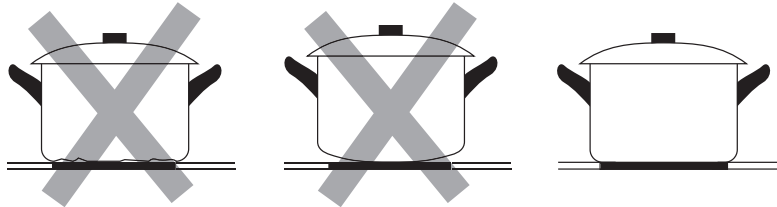

Make sure that the base of your pan is smooth, sits flat against the glass, and is the same size as the cooking zone. Always centre your pan on the cooking zone.

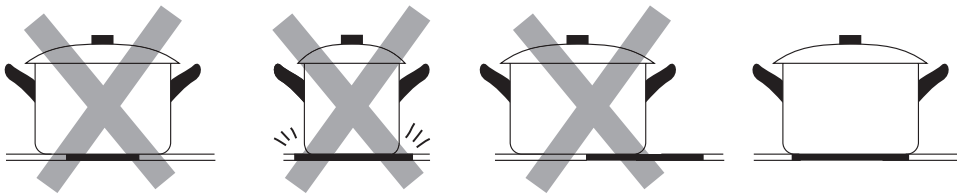

Always lift pans off the ceramic hob – do not slide, or they may scratch the glass.

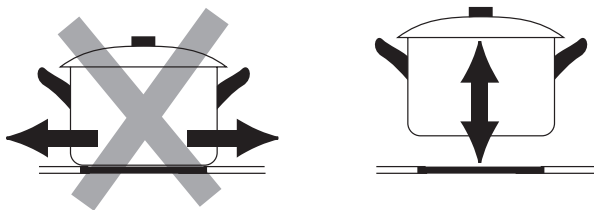

- The heated areas will be seen to switch on and off even when higher heat settings are used. This is due to a safety device, which prevents the glass from overheating. Some switching on and off when cooking at high temperatures is quite normal, causes no damage to the hob and little delay in cooking times. Excessive switching may however be caused by the use of an unsuitable cookware or a saucepan which is smaller than the heated area. If excessive switching occurs, discontinue the use of the cookware.
- To improve performance, and reduce energy, always use pans with close fitting lids.
- If the ceramic hob glass surface is cracked, switch off the appliance to avoid the possibility of electric shock. Contact an authorised repair agent.

Using Your Hob

1. Rotate the control to the heat level (1-6) you wish to use for the selected cooking zone.

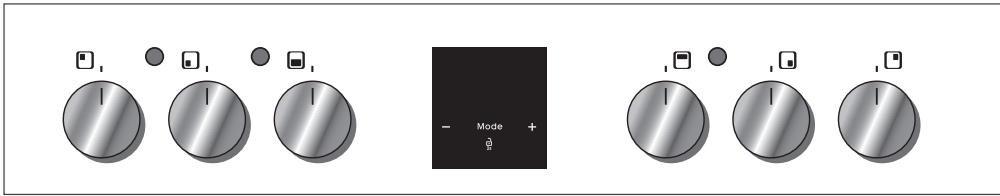

LEVEL 0	LEVEL 1	LEVEL 2	LEVEL 3	LEVEL 4	LEVEL 5	LEVEL 6
OFF	Simmering (Low)	Cooking at medium temperature		Cooking, frying and boiling (High)		

2. When the hob indicator lamp illuminates above the controls, this means that one or more of the hobs are switched on.
3. When you are finished cooking rotate the control back to the "0" position, the hob indicator lamp will turn off. The cooking zones will remain hot for some time. Do not touch the hobs until they have completely cooled down.

First Time Use of the Oven

Ensure that nothing has been left in the top and bottom oven. Remove any insert cards or plastic bags. Before connecting the power, use a damp cloth to carefully wipe the inner cavity wall and housing. Clean all the detachable parts in hot, soapy water before using.

Cycle through all the elements on both ovens on maximum for 10 minutes. There may be a little smoke and odour upon initial start up. This is normal. It is due to the protective substance on the heating elements which protects the cooker from the effects of corrosion during shipping from the factory.



- Under no circumstances should the oven be lined with aluminium foil as overheating may occur.
- Do not place dishes or baking trays directly onto the base of the oven as it becomes very hot and damage may occur.
- Bread may catch fire if the toasting time is too long. Close supervision is necessary during toasting.
- During use, this appliance becomes hot. Care should be taken to avoid touching hot surfaces, e.g., oven door, heating elements.
- Accessible parts may become hot when in use. Children should be kept away.
- Do not leave the handle in position when grilling. If the handle is left in position when grilling, it will get very hot.

Using the Oven

1. On the wall of the inner cavity there are 5 different rack guide slots. You can place the rack at different heights to achieve the best cooking performance depending on the heat of the heating element and the size of the food. It is recommended to preheat the oven for 10 minutes.
2. Always monitor the food during operation to ensure that you are not overcooking it.
3. For heavy food, use a baking pan rather than the oven shelf.
4. During cooking, do not open the door unnecessarily as you will lose heat and your cooking results may be poorer. Cooking times will be longer and energy use will be higher.
5. Using cake tins when cooking cakes will give better results.

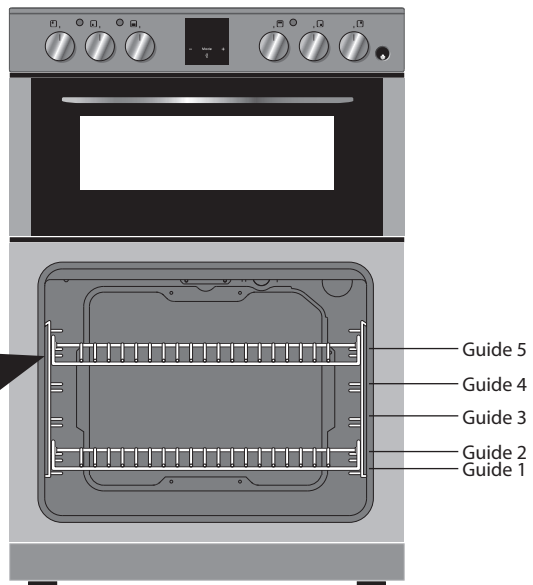
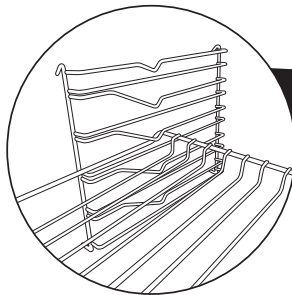

Accessible parts may become hot during use. Young children should be kept away.

12 * All images are for indication only; please refer to your individual unit for actual item.

Replacing the Anti-tilting Oven Shelf

- Insert the shelf at an angle with the vertical section to the rear to clear the stops at either side of the guide slot. Once past this stop the shelf can be placed level again.
- To remove, completely angle the shelf upward so the shelf stop is cleared from the guide stop.

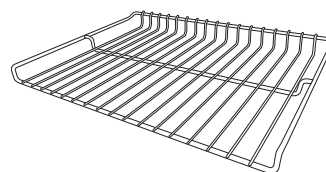

Using the Oven Control

	Function Description
	<p>Defrost Function</p> <p>Defrost function can be started by placing the frozen food into your oven and turning the oven control to the defrost sign or below. Ensure the oven light does not illuminate as this will activate the elements and start the cooking process. This function will not cook the food as only the fan operates, this will help to defrost the food in a very short time. Put the food to be defrosted on the shelf in the third guide slot position and place a tray onto a shelf on the bottom guide slot position to collect the water during defrost.</p>
50 100 150 200 250 MAX	<p>Adjusting the temperature</p> <p>This design spreads the heated air equally in the oven and it is suitable for cooking with one or more trays.</p> <p>Turn the oven control to the desired temperature. It is recommended to preheat the oven for 10 minutes. Place the tray on the shelf.</p> <p>At the end of cooking time, as in all other cooking processes; turn the oven control to off. Take the cooking tray out and put it onto a safe place as it will be hot. Keep children away from the hot oven during and after cooking, until it has completely cooled down.</p>

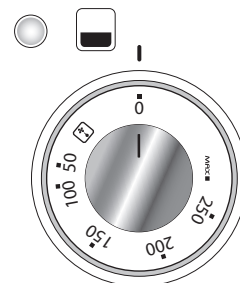





Energy Saving

To save energy and to help protect the environment, we recommend these hints:

- Preheat the oven only if expressly required by the recipe or guidelines.
- Use dark baking tins because they have a higher degree of heat absorption.
- In the case of longer baking times, you can switch off the oven 5–10 minutes before the full baking time and use the residual heat. This will reduce energy usage.
- Use the oven efficiently, by cooking many trays of food at the same time.
- Select the correct shelf location for the food being cooked.
- Do not open the oven door more than necessary.

Using the Grill/Top Oven

Before using the Grill for the first time, heat the grill on maximum for 15 ~ 20 minutes. There may be a little smoke and odour upon initial start up (for about 10 mins). This is normal. It is due to the protective substance on the heating elements which protects the cooker from the effects of corrosion during shipping from the factory.

	Function Description
	<p>Top and Bottom Element</p> <p>Turn the oven control to the desired temperature 50°C - MAX. It is recommended to preheat the oven for 10 minutes. Place the tray on the shelf.</p> <p>At the end of cooking time, as in all other cooking processes; turn the oven control to off. Take the cooking tray out and put it onto a safe place as it will be hot. Keep children away from the hot oven during and after cooking, until it has completely cooled down.</p>
	<p>Bottom Element</p> <p>The bottom element will be full on in this mode, to control cooking temperatures use different shelf positions.</p>
	<p>Top Element</p> <p>The top element will be full on in this mode, to control cooking temperatures use different shelf positions.</p>
	<p>Small Grill</p> <p>This function is used for grilling. In order to grill, please use the grill pan supplied with your product. Turn your grill's control to the required setting.</p> <p>At the end of grilling, as in all other cooking processes; turn the control to the "0" position (off). Take the grill pan out by using the supplied handle and put the pan onto a safe place. Keep children away from the hot oven during and after grilling, until it has completely cooled down.</p>



- The Grill door must be kept open during this function. The door has a position in which the door is open at 30°. This is the minimum the door can be closed during use.
- During use the appliance becomes hot. Care should be taken to avoid touching the heating elements inside the grill.

* All images are for indication only; please refer to your individual unit for actual item.

Place an oven shelf in either guide slot 1 or 2 position. There must be at least 30 mm between the food and the element.

Using the handle, insert the grill rack and tray onto the shelf in guide slot 1 or 2. The food to be cooked must be placed on the grill rack in the grill tray. The handle can be removed once the grill rack tray is in position. Check the food regularly to ensure you do not overcook it.

The grill pan has a detachable handle. Ensure when using the grill pan handle that it is centralised and secure as shown below.

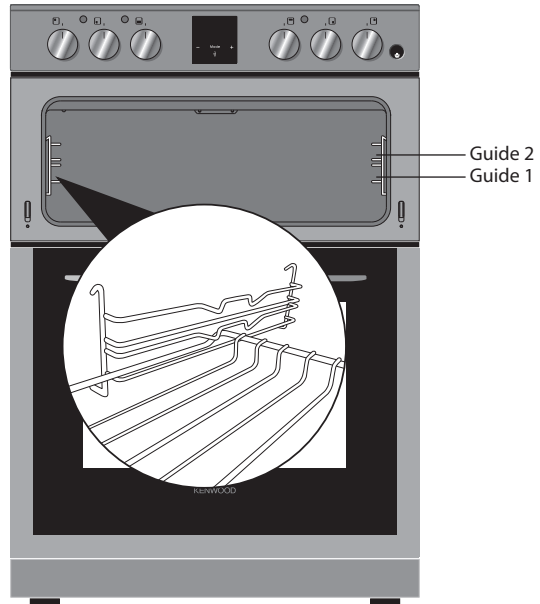

Do not leave the handle in position when grilling. If the handle is left in position when grilling, it will get very hot.

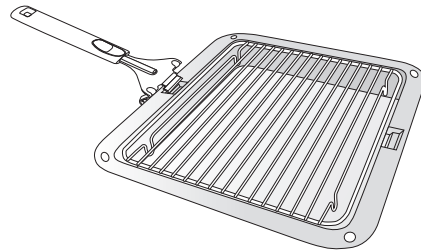
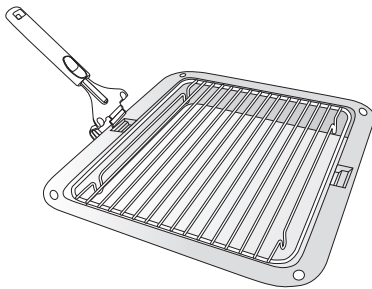

Preheat the grill element for approximately 5-10 minutes before cooking the food.

Ensure a minimum distance of 30 mm exists between the food and the elements. If necessary use a lower guide slot.

Check the food regularly to ensure you do not overcook the food. If slower cooking is required use a lower guide slot or lower grill setting.





Bread may catch fire if the toasting time is too long. Close supervision is necessary during toasting.

Using the Minute Minder Timer

Your cooker has a minute minder that can be used as a kitchen timer. Set an amount of time and the timer will start to count down from your desired time, an alarm will sound once the time has expired. This will not turn your cooker off, it's only a timer. To set the minute minder you'll need to unlock the display, press and hold the **MODE** button for 2 seconds.

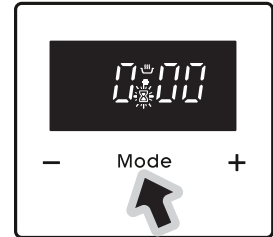
1. Press the **MODE** button until you see the  symbol begin to flash and the time 0:00 will be displayed.



2. While the  symbol is flashing press the '+' button to add a minute at a time, or keep your finger pressed on the '+' button to quickly increase the time. You can also press the '-' button to decrease the amount of time.

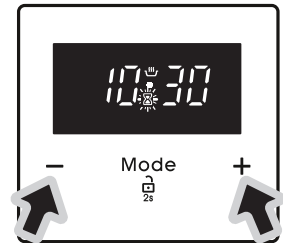

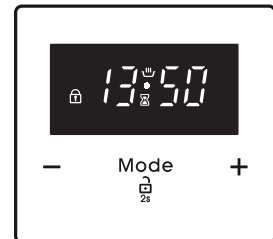

3. When you have set your desired time wait for a few seconds, the  symbol will stop flashing and the current time will be displayed.

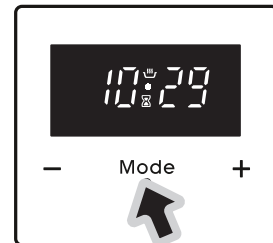

4. If you want to see the time remaining at any point unlock the display then press the **MODE** button and you'll see the time counting down.



5. Once the timer has counted down to 0:00 your cooker will beep and the  symbol will flash. To switch off the beeping alarm press either the + or - buttons. The  symbol will continue to flash until you unlock the display.

The alarm will sound for approximately 7 minutes before automatically switching off if the display is not touched.

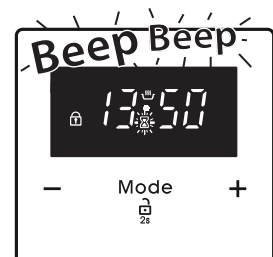

Using the Cooking Timer

Your cooker has a cooking timer that can be used as a timer that will automatically switch your oven off when the time has expired. Switch your oven to your desired cooking temperature, place your food in the oven and set the Cooking Timer. The timer will start to count down from your desired time and an alarm will sound once the time has expired, your oven will also automatically switch off. To set the cooking timer you'll need to unlock the display, press and hold the **MODE** button for 2 seconds.



Feature only available with the main oven.

1. Press the **MODE** button until you see the word END and the current time alternating in the display the **A** symbol will begin to flash.

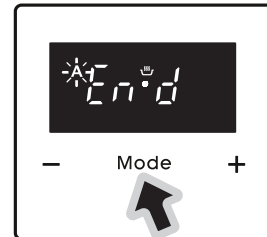

2. Press the '+' button to set the time you would like your cooker to switch off.
You can set a time up to 10 hours after the current time.

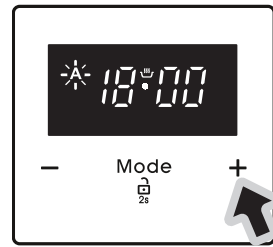

3. When you have set your cooking finish time wait for a few seconds, the **A** symbol will stop flashing and the current time will be displayed. Remember your desired cooking temperature will need to be set at this point.

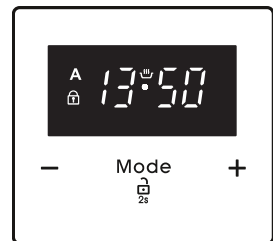

4. Once the time has reached your End time your cooker will switch off and it will beep, the **A** symbol will flash. To switch off the beeping alarm press either the + or - buttons. The **A** symbol remains flashing in the display.

The alarm will sound for approximately 7 minutes before automatically switching off, if the display is not touched.

5. Remember to turn your cooker control back to 0 to fully switch off your cooker.

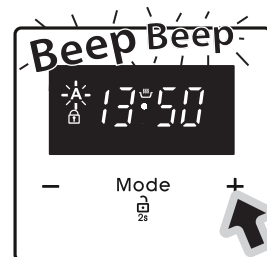

Using the Automatic Cooking Timer

Your cooker has an automatic cooking timer that can be used to set your oven to switch on at your desired time and cook for a set duration. First set the cooking duration time, e.g. 1 hour, 30 minutes, then set the time you want your cooker to switch off, e.g 18:00. Select your desired cooking temperature on the control knob. The automatic cooking timer will now be set. In this example it will switch on at 16:30 and switch off 1 and a half hours later at 18:00, an alarm will sound once the time has expired, your oven will also automatically switch off. To set the cooking timer you'll need to unlock the display, press and hold the **MODE** button for 2 seconds.



Feature only available with the main oven.

Setting the cooking duration

1. Press the **MODE** button until you see the word 'dur' and '0.00' alternating in the display the **A** symbol will begin to flash.

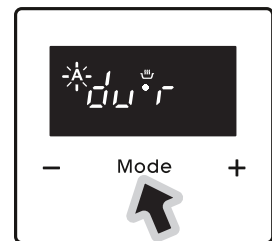

2. Press the '+' or '-' buttons to set the cooking duration time. You can set a time up to 10 hours after the current time.

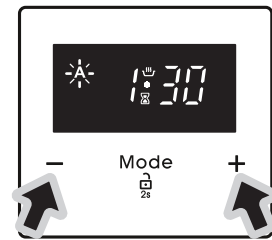

Cooking duration of 1 hour
30 mins

3. When you have set your cooking duration time wait for a few seconds, the **A** and  symbols will be displayed.

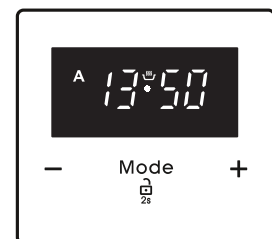

Setting the cooking end time

4. Press the **MODE** button until you see the word END and the current time alternating in the display the **A** symbol will begin to flash.

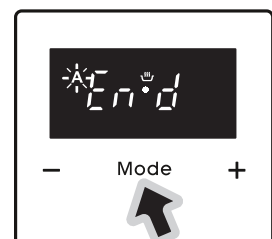

- Press the '+' button to set the time you would like your cooker to switch off.
You can only set the end time 23 hours and 59 minutes into the future.

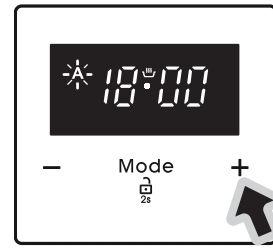

Switch off time 18:00

- When you have set your cooking finish time wait for a few seconds, the **A** symbol will stop flashing and the current time will be displayed. Remember your desired cooking temperature will need to be set at this point.
- Place your food in the main oven and select your desired cooking temperature on the control knob. Remember the oven won't switch on when you do this. It will switch on using the automatic timer you've just set.

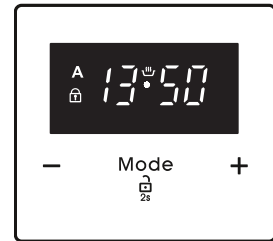

- Using this example your oven will now switch on at 16:30 and cook for 1 and a half hours and switch off at 18:00. When finished it will beep, the **A** symbol will flash. To switch off the beeping alarm press either the + or - buttons. The **A** symbol remain flashing in the display.

The alarm will sound for approximately 7 minutes before automatically switching off, if the display is not touched.

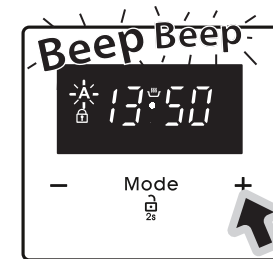

- Remember to turn your cooker control back to 0 to fully switch off your cooker.

Adjusting the Tone of the Timer Alarm

The timer alarm has 3 different tones that you can choose when the alarm sounds.

1. Unlock the display and make use the time is displayed.

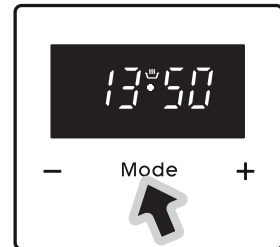

2. Press and hold the - button for 2 seconds. You'll hear a tone and then the display will show the current tone number, either tone 1, 2 or 3.

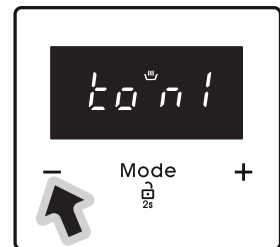

3. Press the - button to scroll through the 3 tones, you will hear each tone with each press of the - button. When you have chosen a tone you like wait a few seconds. When the display returns to the clock your choice has been saved.

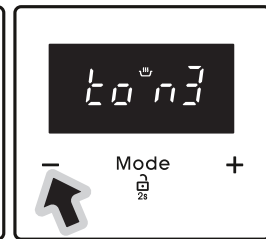
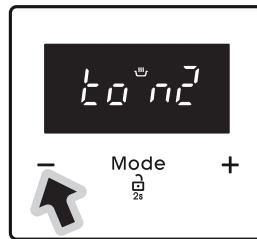
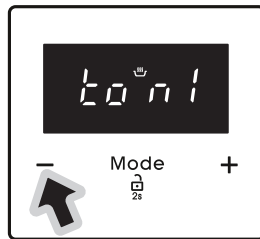

Adjusting the Display Brightness

The display has 8 brightness levels to choose from.

1. Unlock the display and make use the time is displayed.

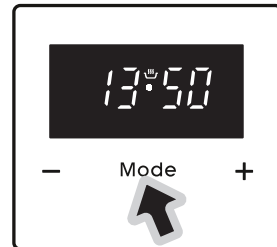

2. Press and hold the '+' button for 2 seconds. You'll hear a tone and then the display will show the current brightness level.

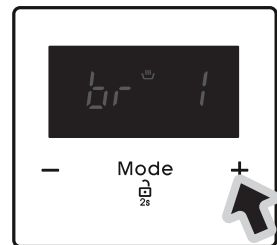

3. Press the + button to scroll through the 8 brightness levels. When you have chosen a brightness level you like wait a few seconds. When the display returns to the clock your choice has been saved.

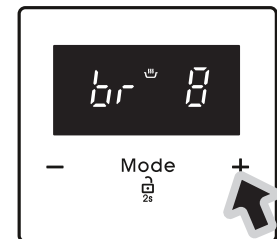
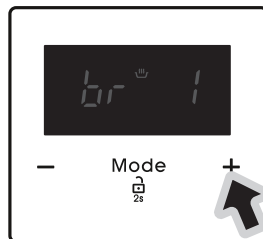

General Advice



Before you start cleaning your cooker, please:

- Read the cleaning instructions and the 'Safety Warnings' sections.
- Turn the cooker off at the mains socket.
- Allow the cooker to completely cool down before cleaning and disconnect the appliance from the electrical supply.
- Do not use a steam cleaner.
- Do not keep flammable substances in, on or near the cooker.

- Wipe the oven clean after every use.
- Wipe up spills. Avoid leaving alkaline or acidic substances (such as lemon juice or vinegar) on the oven surfaces.
- Do not use cleaning products with a chlorine or acidic base.
- Never clean the interior, panel, lid, trays and all other parts of the oven with tools like a hard brush, cleaning mesh or knife. Do not use abrasive, scratching agents and detergents.
- After cleaning the interior parts of the oven with a soapy cloth, rinse it and then dry thoroughly with a soft cloth. Leave the doors open to allow the cavities to completely dry
- Never use flammable agents like acid, thinner and petrol when cleaning your oven.
- Do not wash any part of your oven in a dishwasher.
- If you choose to use a commercial stainless steel cleaner, please read the label to make sure it does not contain chlorine compounds as these are corrosive and may damage the appearance of your cooker.
- Do not use abrasive cleaners, cloths or pads on the outside surfaces. Immediately wipe off any caustic cleaners if they are spilled onto the oven door handles.

Cleaning the Outside of the Cooker

Wipe the outside surfaces often, using warm water and a mild household detergent. Any stainless steel parts may also be cleaned with a suitable cleaner.

Cleaning the Ceramic Hob

- Ensure the cleaning material is designed for cleaning ceramic hobs and does not contain any particles which may cause it to scratch the glass.
- Spilt food must be cleaned right after the hob glass has cooled.
- Do not use steel cleaning material as it may damage the ceramic hob glass.
- Dust on the surface must be cleaned with a damp cloth allow to completely dry before use.
- The glass may discolour if the incorrect cleaning materials are used.

Cleaning the Cooker Door Glass

Do not use harsh abrasive cleaners or sharp metal scrapers to clean the oven door glass since they may scratch the surface, which could result in the glass shattering.



Take care when handling parts with glass, knocks, chips, heavy handling and dropping could cause the glass to shatter.

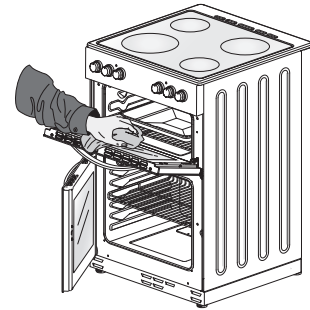

Cleaning the Inside of Your Cooker

- Do not use abrasive cleaners, cloths or pads to clean the enamel.
- Clean the enamel on the inside of the cooker when it has cooled down, using household detergents or an ammonia-based cleaner. You may use an 'off the shelf' oven cleaner, if you carefully follow the manufacturers' instructions.
- The grill door can be removed to allow easier access to the inside of your grill cavity. (See "Removing the Grill Door" section)
- Wipe the cooker after every use with a soft cloth that has been dampened in soapy water. Wipe it again with a wet cloth and then dry it. Do not clean with dry or powder cleansers.
- Do not clean the cooker while the glass panels are hot.
- Clean the cooker with a glass cleaner which is designed to be used with cookers. Then rinse and then dry it with a dry cloth.

Cleaning the Enamel Parts Inside Your Oven

- Do not use abrasive cleaners, cloths or pads to clean the enamel.
- Clean the enamel on the inside of the oven when it has cooled down, using household detergents or an ammonia-based cleaner. You may use an 'off the shelf' oven cleaner, if you carefully follow the manufacturers' instructions.
- The grill door can be removed to allow easier access to the inside of your oven. (See "Removing the Grill Door" section).

* All images are for indication only; please refer to your individual unit for actual item.

Cleaning the Catalytic liners Inside Your Oven

Catalytic liners are installed within the oven cavity. These are the matte-finished, light-coloured panels on the sides of the oven. They work by collecting any grease and oil residue during cooking. Catalytic liners are designed to have a working life of about 300 hours.

The liner self-cleans by absorbing fats and oils and burning them to ash, which can then be easily removed from the floor of the oven with a damp cloth. The lining must be porous to be effective. The liner may discolour with age.

If a large amount of fat is spilled onto the liner, it may reduce its efficiency. To overcome this problem, set the oven to maximum temperature for about 20 - 30 minutes. After the oven has cooled, wipe out the floor of the oven.

Manual cleaning of the catalytic liners is not recommended. Damage will occur if a soap-impregnated steel wool pad or any other abrasives are used. In addition, we do not recommend the use of aerosol cleaners on the liners. The walls of a catalytic liner may become ineffective due to excess grease. The excess grease can be removed with a soft cloth or sponge soaked in hot water and the cleaning cycle can be carried out as described above.

Removing and replacing the catalytic liners

The catalytic liners can be easily removed and replaced.

1. First remove the oven shelves
2. Remove the shelf runners by gently pulling out at the bottom then lifting the runner up.
3. Remove the 4 screws and the liner. Replace with a new catalytic liners.

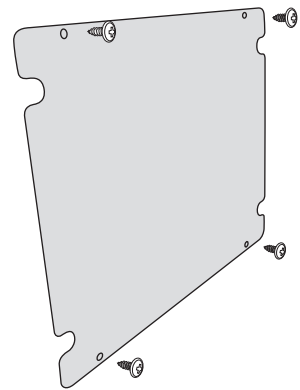

Removing the Grill Door

The grill door can easily be removed as follows:

1. Open the door completely.
2. The swivel retainers of the right hand and left hand hinges are hooked onto the metal bar above them. Lift the retainers as shown.
3. Lift the door slightly. The notch on the bottom of the hinge will disengage.
4. Now pull the oven door forwards off the appliance. Releasing both hinge sections from the slots.

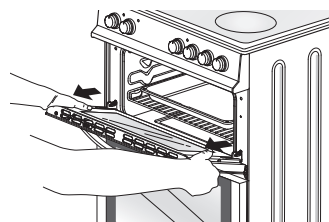
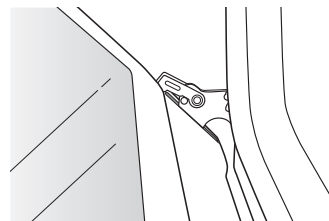
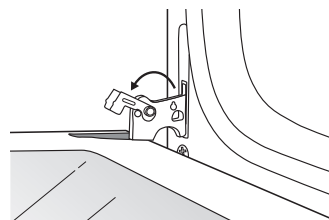
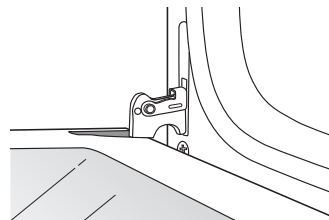

To replace the door, repeat the above steps in reverse order.

* All images are for indication only; please refer to your individual unit for actual item.

Replacing the Oven Lamp

Let the oven cavity cool down.



Ensure that the cooker is switched off before replacing the lamp to avoid the possibility of an electric shock.

- Remove the protective cover.
- Unscrew and replace the bulb with a new one suitable for high temperatures (300°C).
- Refit the protective cover.



Bulb specifications
230V~ 50 Hz, 25W, E14

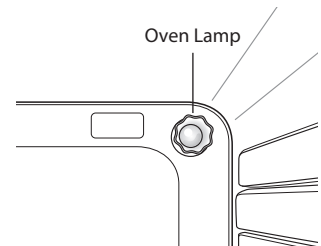

Hints and Tips

Problem	Possible Causes	What To Do
The hob cannot be turned on.	No power.	Make sure the cooker is connected to the mains socket and the socket is switched on. Check whether there is a power outage in your home or area. If you've checked everything and the problem persists, call a qualified technician.
The top oven cannot be turned on.	No power.	Make sure the cooker is connected to the mains socket and the socket is switched on. Check whether there is a power outage in your home or area. If you've checked everything and the problem persists, call a qualified technician.
The main oven cannot be turned on.	<ul style="list-style-type: none"> No power. The oven is set to an Auto cooking mode (A). 	<ul style="list-style-type: none"> Make sure the cooker is connected to the mains socket and the socket is switched on. Check whether there is a power outage in your home or area. If you've checked everything and the problem persists, call a qualified technician. Unlock the display then press the '+' and '-' buttons at the same time to select manual cooking .
The glass has been scratched.	Unsuitable, abrasive scourer or cleaning products being used.	Do not use harsh abrasive cleaners or sharp metal scrapers to clean the glass.
Some pans make crackling or clicking noises.	This may be caused by the construction of your cookware (layers of different metals expanding/shrinking differently).	This is normal for cookware and does not indicate a fault.
The oven temperature is too high or too low.	Wrong temperature selected / or the wrong shelf position was used.	Check that the recommended temperatures and shelf position are being used. Be prepared to adjust the temperature up or down. If the temperature needed is critical use an oven thermometer.
The interior lighting lamp does not light.		The oven must be on for the lamp to light. If the lamp is defective you can change it. (See "Replacing the Oven Lamp" section.)

Problem	Possible Causes	What To Do
The display isn't working properly	<ul style="list-style-type: none"> • The display may be locked • Something may be on the display 	<ul style="list-style-type: none"> • Press and hold the MODE button for 2 seconds to unlock the display. Remember the display will automatically lock after 30 seconds. • Clean the display, moisture on the display may prevent it from working properly.
The oven fan is noisy	<ul style="list-style-type: none"> • Oven shelves may be vibrating 	<ul style="list-style-type: none"> • Check the oven is level. Check that the shelves and any bake ware are not vibrating or in contact with the oven back panel.

Product Fiche and Specifications

Brand	Kenwood
Model	KDC606B19 / KDC66SS19
Product Type	Electric Cooker
Mass of the appliance	53 Kg
Grill (upper cavity)	
Energy Efficiency Index - Conventional	106.3
Energy Class	A
Energy Consumption (electricity) - Conventional	0.75 kWh/cycle
Heat Source	Electric
Volume	37 litres
Main Oven (lower cavity)	
Energy Efficiency Index - Fan Forced	95.0
Energy Class	A
Energy Consumption (electricity) - Conventional	0.79 kWh/cycle
Heat Source	Electric
Volume	67 litres
Number of Cavities	2
This product complies with	EN 60350-1
Overall Dimension (W x D X H)	600(W) x 600(D) HOB [640(D) MAX] x 900(H) mm (Not including Controls or Handles)
Oven Lamp	25W
Thermostat	50 - 285°C
Top oven Grill Heating Element	1600 - 1750 W
Top oven Top Heating Element	700 - 800 W
Top oven Bottom Heating Element	700 - 800 W
Bottom Oven Fan Element	2000 - 2200 W
Supply Voltage	230 - 240V ~ 50 Hz
Radiant Heater 145 mm	1200 W at 230V 1400W at 240V
Radiant Heater 180 mm	1800 W at 230V 2000W at 240V
Type of Hob	Electric
Number of Cooking Zones	4
Heating Zone(s) Small	
Heating Technology	Radiant
Size	14.5 cm diameter
Energy Consumption	192 Wh/Kg
Heating Zone(s) Large	
Heating Technology	Radiant
Size	18 cm diameter
Energy Consumption	192 Wh/Kg
Energy Consumption of Hob	192 Wh/Kg
The Hob complies with	EN 60350-1 & EN 60350-2

Features and specifications are subject to change without prior notice.

Energy Saving Tips and Energy Label

Main Oven

- Cook the meals together, if possible.
- Keep the pre-heating time short.
- Do not elongate cooking time.
- Do not forget to turn off the oven at the end of cooking.
- Do not open the oven door during cooking.

Hob

- Use cookware that has a flat base.
- Use the correct sized cookware for the cooking zone being used.
- Use a lid on your cookware.
- Minimize the amount of liquid or fat used.
- When liquids start boiling reduce the heat.

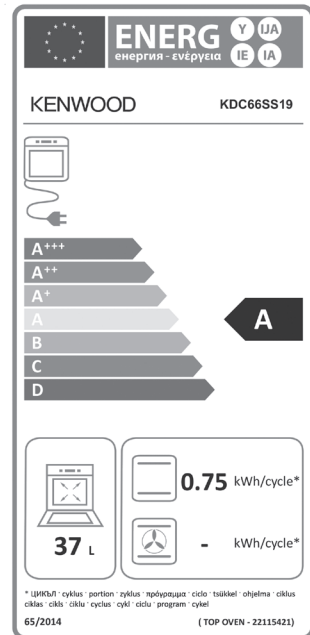
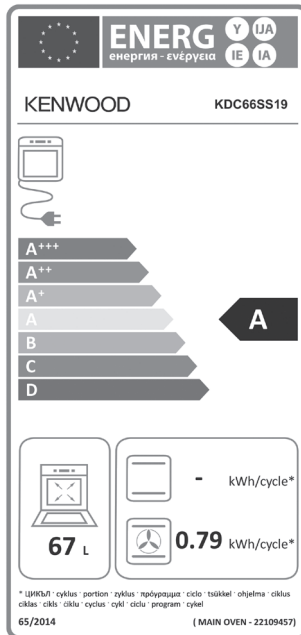
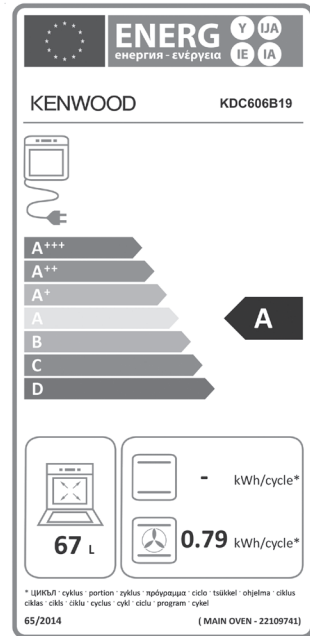
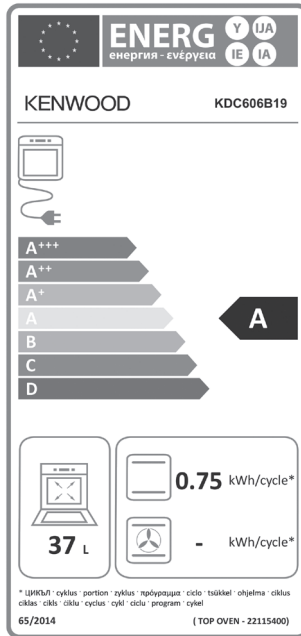

Installation

- The cooker must be installed by a competent person, if in doubt consult a qualified technician, and in compliance with local electrical, safety and building regulation standards.
- If the cooker is installed adjacent to furniture which is higher than the hob, a gap of at least 100 mm must be left between the side of the cooker and the furniture unless non-combustible materials (e.g., ceramic tiles, metal splashback, etc.) are used which then allows this distance to be reduced to 20 mm.
- The furniture walls adjacent to the cooker must be made of heat resistant material (check with your furniture supplier). The veneered synthetic material and the glue used must be resistant to a temperature of 100°C in order to avoid ungluing or deformations.
- The cooker may be located in a kitchen, a kitchen/diner or bed-sitting room but not in a room containing a bath or shower.
- Flammable materials such as curtains, wood, wallpaper, etc. must not be fitted immediately behind the appliance or within 500 mm of the sides.
- Do not place next to a refrigerator.
- This cooker must **NOT** be placed on a pedestal or base.
- It is essential that the cooker is positioned as stated or freestanding taking into account the distances of any combustible materials detailed above.
- Any cooker hoods must be installed according to the requirements of the cooker hood instruction/installation manual but no less than 650 mm.
- Any cupboards placed directly above the cooker must be no less than 700 mm.

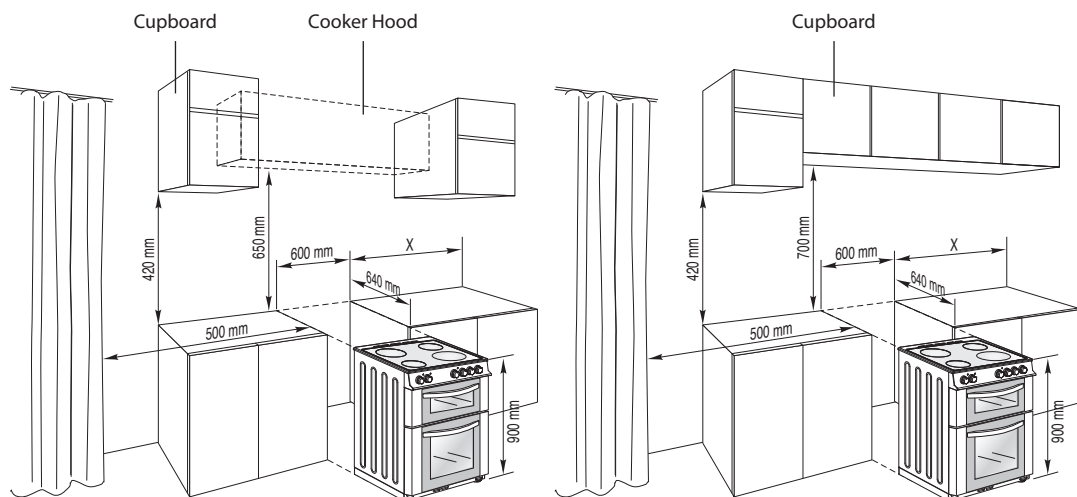

For all dimensions marked "X", please refer to the information below:

X : 100mm for combustible materials
20mm for non-combustible materials.

* All images are for indication only; please refer to your individual unit for actual item.

Adjusting the Feet



Using the fitted adjustable feet is **MANDATORY**. For safety reasons and to ensure adequate ventilation, the cooker chassis **MUST NOT** sit directly on the floor, a plinth, or other support surface.

The cooker stands on 4 levelling legs. As the levelling legs are adjusted at lower position, it is required to control whether the product is levelled before operating it. This adjustment can be made by turning the levelling leg clockwise to raise the cooker, if required. It is possible to raise the product a maximum of 30mm via the levelling leg. If the levelling legs are adjusted appropriately, the product must **NOT** be moved by dragging. The cooker must always be moved by lifting it up. The levelling leg can be adjusted by hand or a metal plate of the correct size to fit the slot.

Level the cooker by screwing the bottom of the feet in or out, as shown.

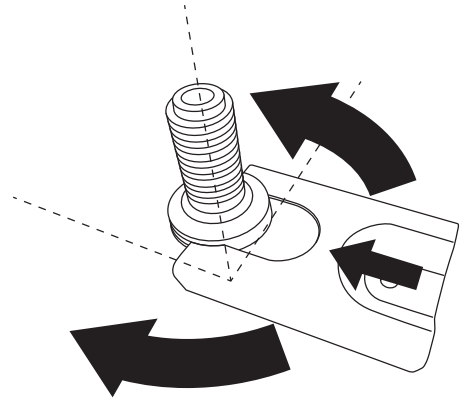

The Stability bracket can be used as a tool to adjust the levelling legs.

Moving the Cooker



- Two people must always raise the cooker, as shown, to prevent damaging the adjustable feet.
- Do not lift the cooker by the door handles.
- **DO NOT DRAG** the cooker. Lift the feet clear of the floor.

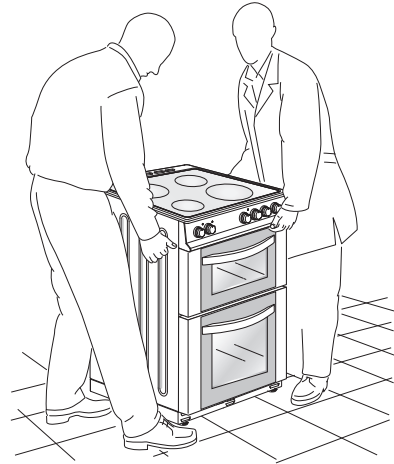

* All images are for indication only; please refer to your individual unit for actual item.

Stability Bracket

The supplied stability bracket or a recognized cooker stability device **MUST** be fitted.

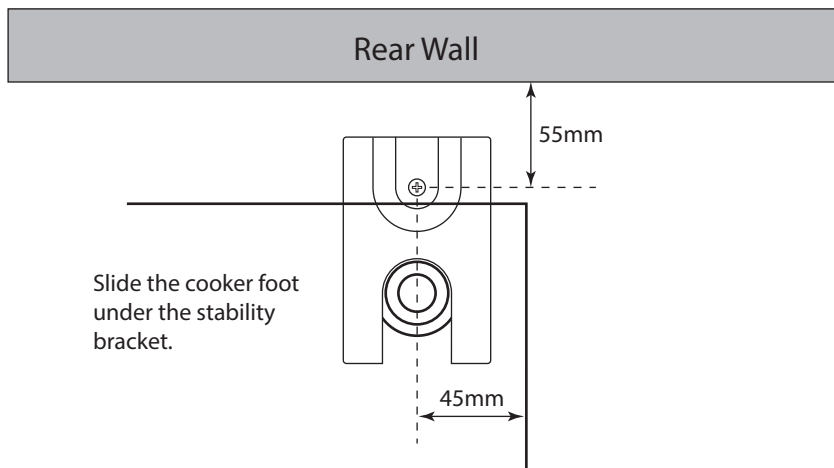
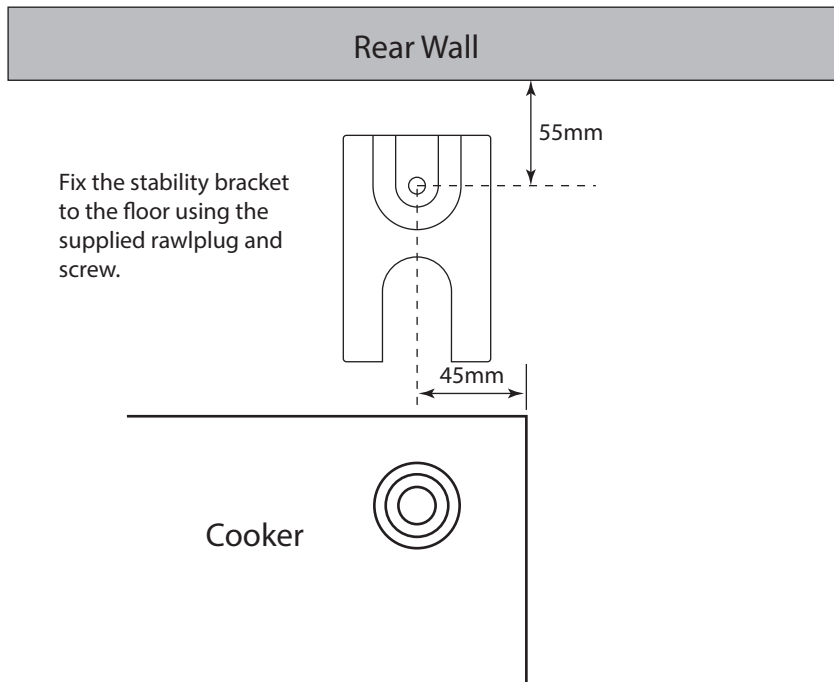

The stability bracket can be used on either of the rear feet.

Electrical Connection

Electric cookers come without a power supply cable. The cooker is designed to operate on an electricity supply which conforms to the electrical data shown on the Rating Plate. The cooker can be connected to the mains only after you complete the connection at the junction box.



The following installation procedure must be carried out by a competent person. If in doubt consult a qualified electrician. The electrical installation must comply with the IEE Regulations, Building & local By-Laws.

For the installation of the supply cable carry out the following operations:

- Release both clips then open the junction box lid.

Colours of the wires in the mains lead should correspond with the markings identifying the terminals. Proceed as follows:

Green & Yellow wire to terminal marked "E" or \perp .

Brown wire to terminal marked "L".

Blue wire to terminal marked "N".

Ensure all screws are adequately tightened. Do not over tighten as you may risk damaging the screw threads.

- Fix the supply cable in the cable clamp and then close the cover.

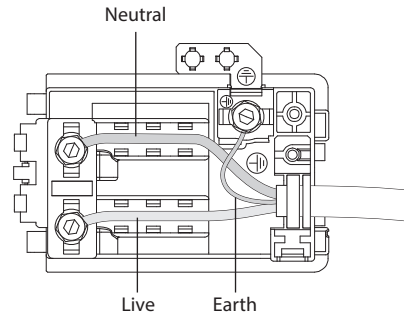

The power supply cable must have these minimum requirements:

- Type: H05VV-F (PVC insulated and sheathed flexible cable)
- Section: 3 core x 4 mm²

This appliance must be earthed.



- The cooker must be connected to the mains supply via a switch providing full disconnection correctly fused with a capacity appropriate to that shown on the cooker Rating Plate and incorporated in the fixed wiring in accordance with the latest wiring regulations. All electrical wiring from the consumer unit to the cooker, via the full disconnection switch must be of the correct rating.
- The mains cable must be positioned away from any hot parts at the rear of the cooker. If this cannot be done then another method of protecting the mains cable from the hot parts must be used i.e. Heat resistant sleeving or high temperature cables.

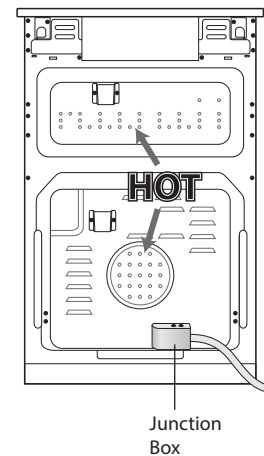

* All images are for indication only; please refer to your individual unit for actual item.

Need Help with your product?

Your product is supported by Team Knowhow

under a Trademark Licence from Fisher & Paykel Appliances Italy SpA.

For help or spare parts please call us on:

0344 561 1234

Partmaster
CO.UK

Visit Partmaster.co.uk today for the easiest way to buy electrical spares and accessories. With over 1 million spares and accessories available we can deliver direct to your door the very next day. Visit www.partmaster.co.uk or call **0344 800 3456** (UK customers only) Calls charged at National Rate.



The symbol on the product or its packaging indicates that this product must not be disposed of with your other household waste. Instead, it is your responsibility to dispose of your waste equipment by handing it over to a designated collection point for the recycling of waste electrical and electronic equipment. The separate collection and recycling of your waste equipment at the time of disposal will help conserve natural resources and ensure that it is recycled in a manner that protects human health and the environment.

For more information about where you can drop off your waste for recycling, please contact your local authority, or where you purchased your product.

DSG Retail Ltd. (co. no. 504877)
1 Portal Way, London, W3 6RS, UK

EU Representative
DSG Retail Ireland Ltd (259460)
3rd Floor Office Suite
Omni Park SC, Santry, Dublin 9, Republic of Ireland

Manufactured for DSG Retail Limited under Licence from Fisher & Paykel Appliances Italy SpA.
DSG Retail Limited is responsible for after sales service.

IB-KDC606B19/KDC66SS19-190614V1