

# JVC

GB

Instruction Manual

55" LED Smart 4K HDR TV  
LT-55C898



prime video

NETFLIX

4K ULTRA HD

HDR

dts TruSurround

dts-HD

FreeviewPlay

DOLBY VISION

HDMI HIGH-DEFINITION MULTIMEDIA INTERFACE

# Contents

<b>1</b>	<b>Safety Warnings</b>	<b>4</b>
<b>2</b>	<b>Preparation</b>	<b>7</b>
	Unpacking the TV	7
	Installing / Removing the Base Stand	8
	– Fitting the Neck and Neck Cover Together	8
	– Fitting the Neck and Stand to the TV	8
	Mounting the TV to a Wall	9
	Front / Right Side View and Controls	9
	Rear View and Sockets	10
	Installing Batteries in the Remote Control	11
	Remote Control Operation Range	11
	TV Stand Angle	11
	Remote Control	12
<b>3</b>	<b>Initial Setup</b>	<b>14</b>
	Turning the TV On for the First Time	14
	– Choose Region (UK only)	18
	– Connecting an Analogue Device	19
	– Channel Selection	20
	– Display Channel Information	20
	– Volume Adjustment	20
	– Using the buttons on the back of the TV	20
<b>4</b>	<b>Customising TV Settings</b>	<b>21</b>
	Adjusting the Picture Settings	21
	– Common Picture Options	21
	Adjusting the Sound Settings	23
	– Common Sound Options	23
	Editing the Channel List	25
	Filtering the Channel List	26
	Viewing your Favourite Channel List	26
	Home Menu	27
	– Moving an item on the Home Menu bar	27
	– Deleting an item on the Home Menu bar	27
	– Adding an item to the Home Menu bar	27
<b>5</b>	<b>Using the Features</b>	<b>28</b>
	Programme Guide	28
	– Switch On / Off Programme Guide	28
	– Select a Programme	28
	– Record a Programme	28
	Time Shift Recording onto a USB Storage Device	30
	Recording DTV Programmes onto a USB Storage Device	31
	Setting a Timer or Timed Recording	32
	– Editing a Timer	33
	– Deleting a Timer	33
	Playing Recorded Programmes	34
	– Editing a Recording	34
	– Deleting a Recording	34
	– Sorting a Recordings	35
	– Recording Settings	35
	Red Button + (Interactive services)	36
	– Accessing the Information	36
	Listening to the Radio	36
<b>6</b>	<b>Using the Smart Features</b>	<b>37</b>
	Connecting to the Internet (Wired)	37

Connecting to the Internet using wireless.....	38
– Wake On.....	38
Connecting to the WPS button.....	39
Using Freeview Play.....	40
– Catch Up Services.....	40
– Recommendations.....	40
– Freeview Apps Updating.....	41
– Freeview Play 7 day Catch Up through the Programme Guide.....	41
Using Smart TV.....	42
– Apps.....	42
– Deleting an app from Apps.....	42
– Market.....	43
– Searching for Apps.....	43
Using the Internet Browser.....	44
– Adding Bookmarks.....	44
– Adding Tabs.....	44
– Adding a Site to Speed Dial.....	45
– Editing Speed Dial.....	45
– Opera Menu.....	45
Casting You Tube to your TV.....	46
<b>7 Other Information.....</b>	<b>47</b>
CI (Common Interface) (DTV Mode).....	47
Privacy Settings.....	48
Time Settings.....	49
Accessibility Settings.....	49
More Settings.....	50
– HDMI ARC (Audio Return Channel).....	51
Language Settings.....	52
Sources.....	52
– Editing the Source.....	52
Resetting your TV.....	53
Parental Settings.....	54
<b>8 Entertainment.....</b>	<b>55</b>
Connecting a USB Storage Device.....	55
Media Browser.....	56
– Media Browser Settings.....	56
<b>9 Technical Information and Help.....</b>	<b>57</b>
Maintenance.....	57
Hints and Tips.....	58
Remote Control Codes.....	60
– Sky Codes.....	60
– Virgin Media Codes (TiVo box).....	60
– BT Vision.....	60
Declaration of Conformity.....	60
Product Fiche and Specifications.....	61
License Information used with JVC Televisions.....	62

# Safety Warnings

- Read all the instructions carefully before using the unit and keep them for future reference.
- Retain the manual. If you pass the unit onto a third party make sure to include this manual.
- Check that the voltage marked on the rating label matches your mains voltage.
- **WARNING:** Never let people (including children) with reduced physical, sensory or mental capabilities or lack of experience and / or knowledge use electrical devices unsupervised.
- To avoid danger of suffocation, keep plastic bags out of reach of babies, children and domestic animals.
- Carefully attach the stand to the TV. If the stand is provided with screws, tighten the screws firmly to prevent the TV from tilting. Do not over tighten the screws and mount the stand rubbers properly.

## Damage

- Please inspect the unit for damage after unpacking.
- Do not continue to operate the unit if you are in any doubt about it working normally, or if it is damaged in any way - switch off, withdraw the mains plug and consult your dealer.

## Location of Unit

- The unit must be placed on a flat stable surface and should not be subjected to vibrations.
- Do not place the unit on sloped or unstable surfaces as the unit may fall off or tip over causing serious personal injury or death.
- The mains socket must be located near the unit and should be easily accessible.
- This unit is designed for indoor, domestic use only.
- Use this TV set at an altitude of less than 2000 meters above sea level, in dry locations and in regions with moderate or tropical climates.

Many injuries, particularly to children, can be avoided by taking simple precautions such as;

- Using cabinets or stands recommended by the manufacturer of the television set.
- Only use furniture that can safely support the television set.
- Ensuring the television set is not overhanging the edge of the supporting furniture.
- Not placing the television set on tall furniture (for example, cupboards or bookcases) without anchoring both furniture and the television set to a suitable support.
- Not standing the television set on cloth or other materials placed between the television and supporting furniture.
- Educating children about the dangers of climbing on furniture to reach the television set or its controls. If your existing television set is being retained and relocated, the same considerations as above should be applied.

## Wall Mounting

- Read the TV and wall mount instructions before mounting your TV on the wall.
- For TVs over 40" in size, wall mounting requires 2 people to lift and position the TV on to the wall mount.
- The wall mount bracket is not supplied, they can be purchased from your dealer.
- Do not install the TV on a ceiling or an inclined wall.
- Only use the screws supplied with the wall mount bracket when attaching the TV to the bracket. See your TV instructions for screw type.
- Tighten the wall mount screw firmly to prevent the TV from falling. Do not over tighten the screws.
- If you are in any doubt how to mount your TV, contact a professional.

## Temperature

- Avoid extreme degrees of temperature, either hot or cold. Place the unit well away from heat sources such as radiators or gas / electric fires.
- Avoid exposure to direct sunlight and other sources of heat.

## Naked Flames

- Never place any type of candle or naked flame on the top of or near the unit.

## Moisture

- To reduce the risk of fire, electric shock or product damage, do not expose this unit to rain, moisture, dripping or splashing. No objects filled with liquids, such as vases, should be placed on the unit.
- If you spill any liquid into the unit, it can cause serious damage. Switch it off at the mains immediately. Withdraw the mains plug and consult your dealer.

## Ventilation

- To prevent the risk of electric shock or fire hazard due to overheating, ensure that curtains and other materials do not obstruct the ventilation vents.
- Do not install or place this unit in a bookcase, built-in cabinet or in another confined space. Ensure the unit is well ventilated.
- Make sure that there is a gap of at least 10 cm on both sides and a gap of 20 cm at the top.

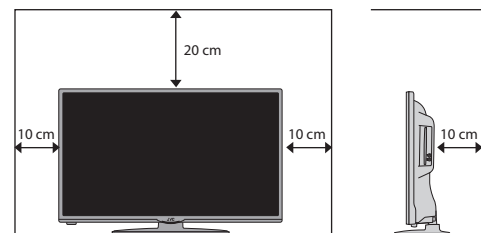

## Safety

- Always disconnect the unit from the mains supply before connecting / disconnecting other devices or moving the unit.
- Unplug the unit from the mains socket during a lightning storm and long inactivity periods (going on holiday).

**Mains Cable**

- Make sure the unit or unit stand is not resting on top of the mains cable, as the weight of the unit may damage the mains cable and create a safety hazard.
- A damaged power cord/plug can cause fire or give you an electric shock. Handle the power cord by the plug, do not unplug the TV by pulling the power cord. Never touch the power cord/plug with wet hands as this could cause a short circuit or electric shock. Never make a knot in the power cord or tie it with other cords. If the mains cable is damaged it must be replaced by the manufacturer, its service agent, or similarly qualified persons in order to avoid a hazard.

**Interference**

- Do not place the unit on or near appliances which may cause electromagnetic interference. If you do, it may adversely affect the operating performance of the unit, and cause a distorted picture or sound.

**Optimum viewing**

- View the unit in moderate light to prevent eye strain. It is recommended to watch the unit from a distance 3-7 times that of the screen height.

**LCD screen**

- The LCD screen is manufactured using high-precision technology. However, some tiny black points and / or bright points (red, blue or green in colour) may constantly appear on the LCD screen. These points are generated in the manufacturing process and are normal.

**Screen Burn**

- A characteristic of Plasma and TV Panels is that displaying the same image for a long time may cause a permanent after-image to remain on the screen. This is called screen burn. Most pictures shown on the unit will be constantly moving and fill the screen.
- Examples of images that you need to watch out for are as follows (this is not an all-inclusive list):
  - 1. Black Bars:** If black bars appear at the left / right or top / bottom of the screen, it is recommended to change the format so that the picture fills the entire screen.
  - 2. TV Channel Logos:** e.g. Shopping channel logos and pricing displays - especially if they are bright and stationary. Moving or low-contrast graphics are less likely to cause ageing of the screen.
  - 3. Time Displays**
  - 4. Teletext:** Do not view a stationary page for long periods of time.
  - 5. TV Menus**
  - 6. Pause Mode:** Do not leave the screen in pause mode for long periods of time, e.g. when watching videos.
- To prevent screen burn if viewing any of the above for long periods of time, reduce contrast and brightness when viewing. Once burn-in occurs it will never disappear completely.

**Country Restrictions for Wireless Internet**

- This device is intended for home and office use in all EU countries (and other countries following the relevant EU directive) without any limitation except for the countries mentioned below.

Country	Restriction
Bulgaria (BG)	General authorization required for outdoor use and public service
France (FR)	In-door use only for 2454-2483.5 MHz
Italy (IT)	If used outside of own premises, general authorization is required
Greece (GR)	In-door use only for 5470 MHz to 5725 MHz band
Luxembourg (EL)	General authorization required for network and service supply(not for spectrum)
Norway (NO)	Radio transmission is prohibited for the geographical area within a radius of 20 km from the centre of Ny-Ålesund
Russian Federation (RU)	In-door use only

- The requirements for any country may change at any time. It's recommended that user checks with local authorities for the current status of their national regulations for both 2.4 GHz and 5 GHz wireless LAN's.

**Earphones**

- Listening to loud sounds for prolonged periods of time may permanently damage your hearing.
- Before putting on earphones, turn the volume down then put the earphones on and slowly increase the volume until you reach a comfortable listening level.

**Standby**

- The  button on the remote control does not switch off the unit completely. The unit will continue to draw electricity from the mains supply while in standby. In the interests of safety and to avoid unnecessary energy consumption, never leave the unit in standby while unattended for long periods of time, e.g. overnight, while on holiday or while out of the house. Disconnect the mains plug from the mains socket.

**Batteries**

- Batteries used in the remote control for this unit are easily swallowed by young children and this is dangerous.
- Keep loose batteries away from young children and make sure that the battery holder tray is secure in the remote control. Seek medical advice if you believe a cell has been swallowed.
- Please dispose of batteries correctly by following the guidance in this manual.
- Do not dispose of batteries in fire or with hazardous or flammable materials.
- The batteries shall not be exposed to excessive heat such as sunshine, fire or the like.

**Supervision**

- Children should be supervised to ensure that they do not play with the unit and the remote control.
- Never let anyone especially children push anything into the holes, slots or any other openings in the case - this could result in a fatal electric shock.

## 1 Safety Warnings

### Earthing

- Apparatus connected to the protective earthing of the building installation through the MAINS connection or through other apparatus with a connection to protective earthing - and to a television distribution system using coaxial cable, may in some circumstances create a fire hazard. Connection to a television distribution system has therefore to be provided through a device providing electrical isolation below a certain frequency range (galvanic isolator, see EN 60728-11)



The lightning flash with arrowhead symbol, within an equilateral triangle, is intended to alert the user to the presence of uninsulated "dangerous voltage" within the unit's enclosure that may be of sufficient magnitude to constitute a risk of electric shock.



The exclamation point within an equilateral triangle is intended to alert the user to the presence of important operating and maintenance (servicing) instructions in the manual accompanying the unit.

### Service

- To reduce the risk of electric shock, do not remove screws. The unit does not contain any user-serviceable parts. Please leave all maintenance work to qualified personnel.
- Do not open any fixed covers as this may expose dangerous voltages.

### Maintenance

- Ensure to unplug the unit from the mains socket before cleaning.
- Do not use any type of abrasive pad or abrasive cleaning solutions as these may damage the unit's surface.
- Do not use liquids to clean the unit.
- The wall socket plug is used as a disconnect device, the disconnect device should be readily accessible.
- This equipment is a Class II or double insulated electrical appliance. It has been designed in such a way that it does not require a safety connection to electrical earth.



To prevent the spread of fire, keep candles or other open flames away from this product at all times.

**Thank you** for purchasing your new JVC TV.

Your new TV has many features and incorporates the latest technology to enhance your viewing experience. We recommend that you spend some time reading this instruction manual so that you fully understand these features. You will also find some hints and tips to help you resolve any issues.

Read all the safety instructions carefully before use and keep this instruction manual for future reference.

## Unpacking the TV

Remove all packaging from the TV. Retain the packaging. If you dispose of it please do so according to local regulations.

The following items are included:



Screws x5



Screws x6



Remote Control /  
AAA Batteries x 2

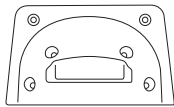

TV Stand Neck Cover and  
Neck



TV Stand Base



Instruction Manual



Quick Start Guide

## Installing / Removing the Base Stand



The LCD display is very fragile, and must be protected at all times when installing and removing the base stand. Be sure that no hard or sharp object, or anything that could scratch or damage the LCD display, comes into contact with it. DO NOT exert pressure on the front of the TV at any time because the screen could crack.

### Fitting the Neck and Neck Cover

#### Together

1. Fit the neck cover over the neck.
2. Using 2 of the supplied screws (A), screw the neck and neck cover together.

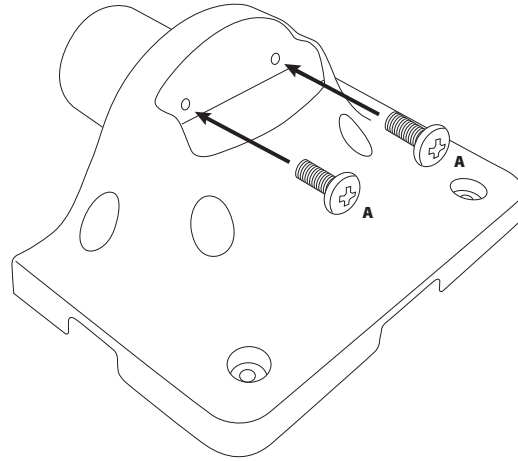

### Fitting the Neck and Stand to the TV

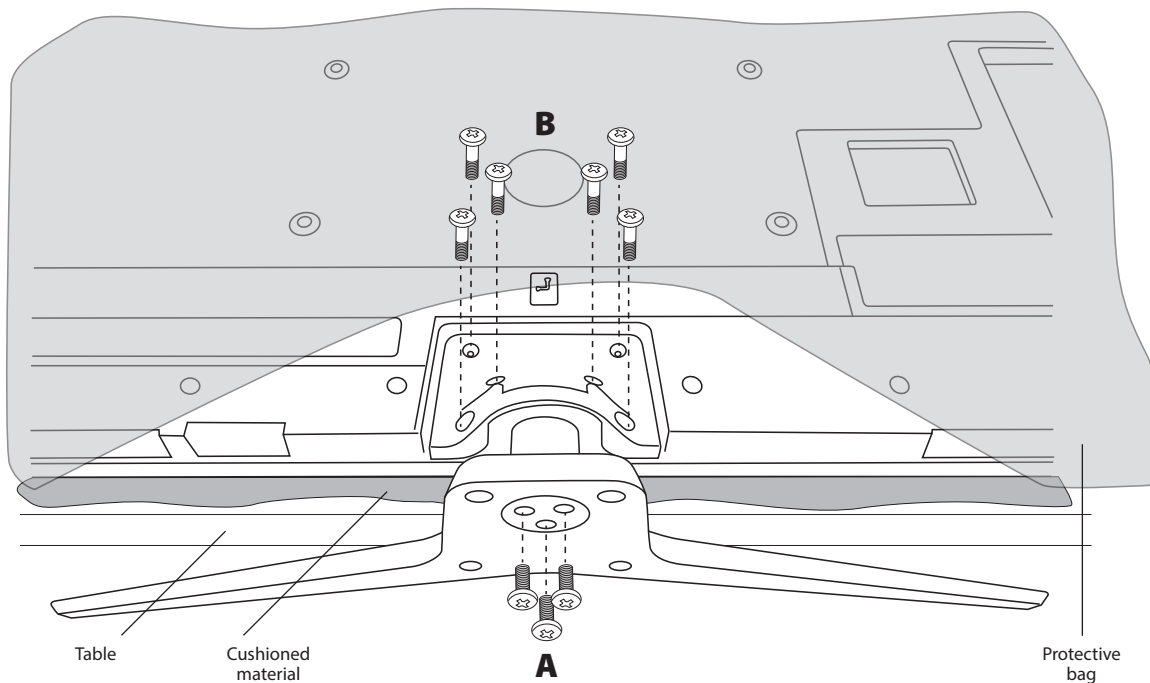

3. Ensure the TV is switched off and not connected to the mains power supply.
4. Lay the TV down on a flat surface ideally on the edge of a table so the base of the TV slightly overhangs the edge of the table, with the back side facing up. Please make sure a soft cushioned material (such as a dry bath towel or thick piece of foam) is placed beneath the screen. You can leave the protective bag on to protect the TV at this point.
5. Slide the Neck and Neck cover under the lip, the neck will fit snugly over the screw holes. Then screw the Neck to the TV using the 6 screws (B) supplied.
6. Once the Neck is secure screw the base to the neck using the 3 screws (A) supplied. Be careful not to drop the base, its heavy.



## Mounting the TV to a Wall



Remove the stand assembly before mounting the TV onto the wall.

1. Remove the 6 screws (B) from the neck of the stand and detach the stand.
2. This TV is designed to be wall-mounted with a standard 200 mm x 400 mm mounting kit (sold separately) designed for flat-panel TVs. Mount this TV according to the instructions included in the mounting kit. Due to space restrictions, we recommend that you make all connections before mounting on to the wall.

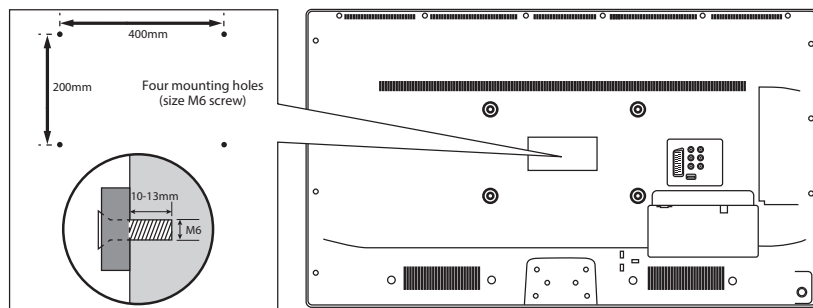
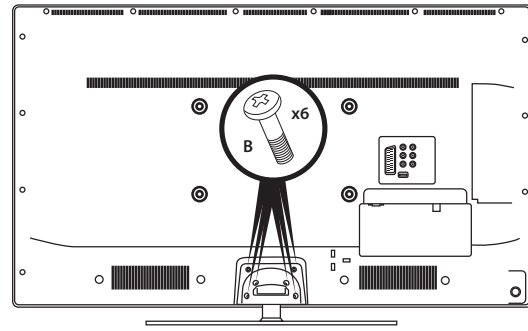

- If you are wall mounting your TV you may wish to buy a 90° HDMI adapter. This will help with your cable management.
- Please read this instruction manual carefully while setting up your TV.
- If you require additional assistance please call our Call Centre on (UK) **0344 561 1234** or (Ireland) **1 890 818 575**. Our Customer Contact Centre is open Monday-Saturday 8am-8pm or Sunday 8am-6pm.

## Front / Right Side View and Controls

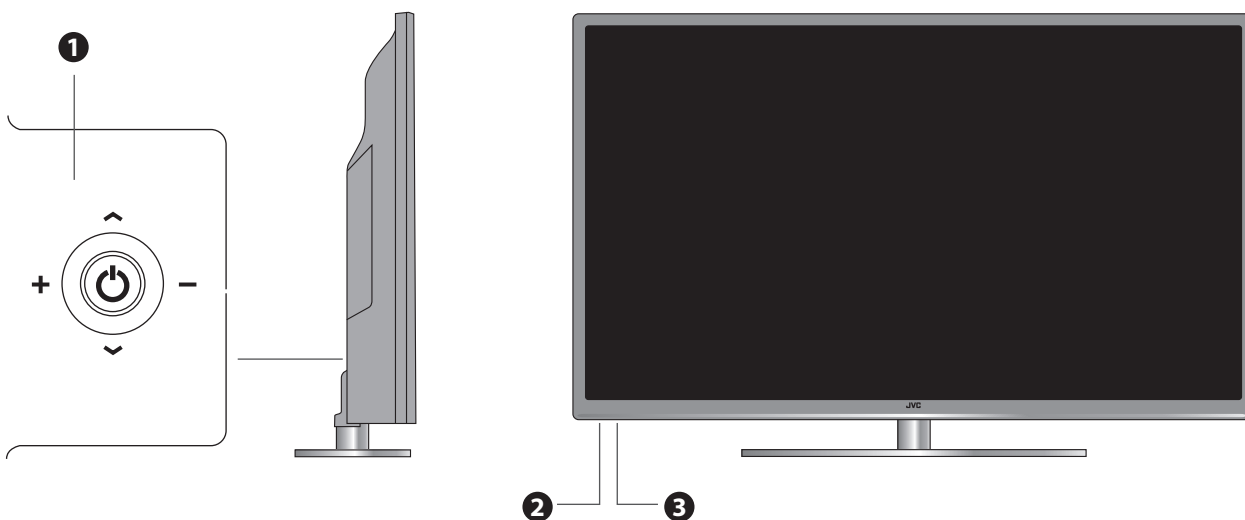

Item	Description
1 <b>MULTI FUNCTION SWITCH</b>	Switches the TV into standby and on. Selects modes (channel,volume, and source).
2 <b>POWER LED</b>	Illuminates when the TV is in standby mode. The LED will blink confirming that a timer recording programme has started in the standby mode.
3 <b>IR (Infrared Receiver)</b>	Receives IR signals from the remote control. Do not put anything near the sensor, as its function may be affected.

## Rear View and Sockets

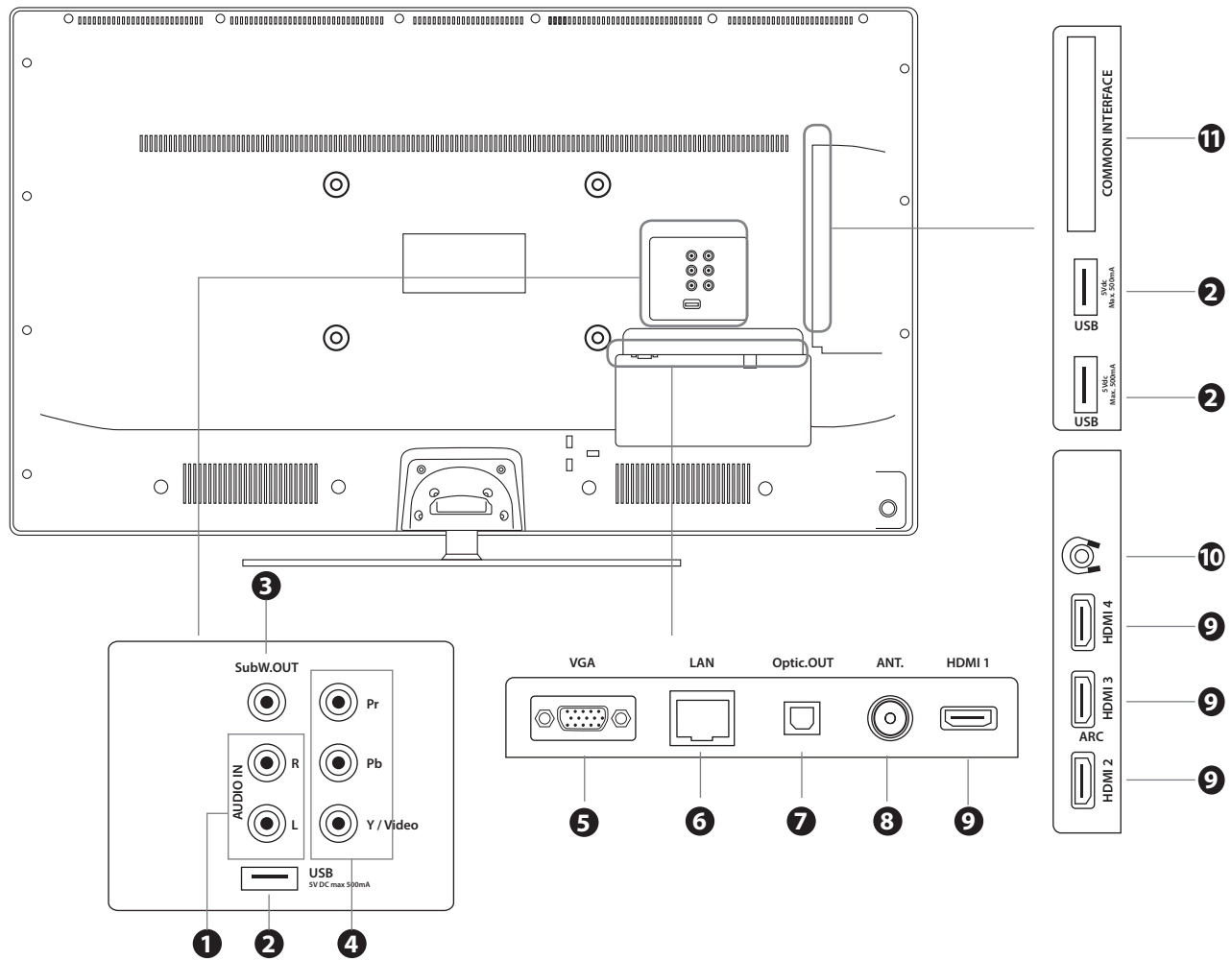

Item	Description
<b>1 AUDIO IN</b>	AUDIO (L/R) output sockets on external video devices.
<b>2 USB</b>	Allows the insertion of a USB storage device to play video, audio, photo and text files (USB mode) and record DTV programmes on to a USB storage device.
<b>3 SubW.OUT</b>	Connects to an external subwoofer.
<b>4 YPbPr</b>	Connects to a DVD player, Digital Set-Top-Box, or other AV devices with component (YPbPr) video and audio output sockets.
<b>5 VGA</b>	Connects to a computer or other devices with a VGA interface.
<b>6 LAN</b>	Connect to a router via a LAN cable for smart TV services.
<b>7 Optic OUT</b>	Optical audio out (Digital) - Connects to an audio device via an optical cable.
<b>8 ANT</b>	Connects to the aerial socket on the wall with the RF coaxial cable.
<b>9 HDMI 1,2,3(ARC) &amp; 4</b>	Connects to a High-Definition (HD) signal output device, such as a set-top box, blu-ray disc player or AV receiver.
<b>10</b>	Connects to the headphones.
<b>11 COMMON INTERFACE</b>	Allows the insertion of a Common Access Module.

## Installing Batteries in the Remote Control

1. Slide open the battery compartment on the back of the remote control.
2. Insert two AAA size batteries. Make sure to match the (+) and (-) ends of the batteries with the (+) and (-) ends indicated in the battery compartment.
3. Replace the battery compartment cover. Make sure it clicks into place. For extra safety use the screw supplied to screw the battery compartment closed.

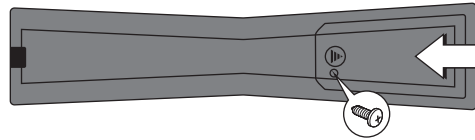
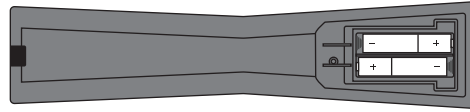
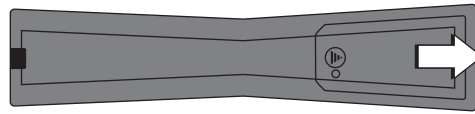

### Handling the Batteries

- Improper or incorrect use of batteries may cause corrosion or battery leakage, which could cause fire, personal injury or damage to property.
- Only use the battery type indicated in this manual.
- When the batteries are exhausted, the remote will not function. Replace both batteries at the same time with new ones.
- Do not install new batteries with used ones and do not mix different types of batteries.
- Do not dispose of used batteries as domestic waste. Dispose of them in accordance with local regulations.

### Handling the Remote Control







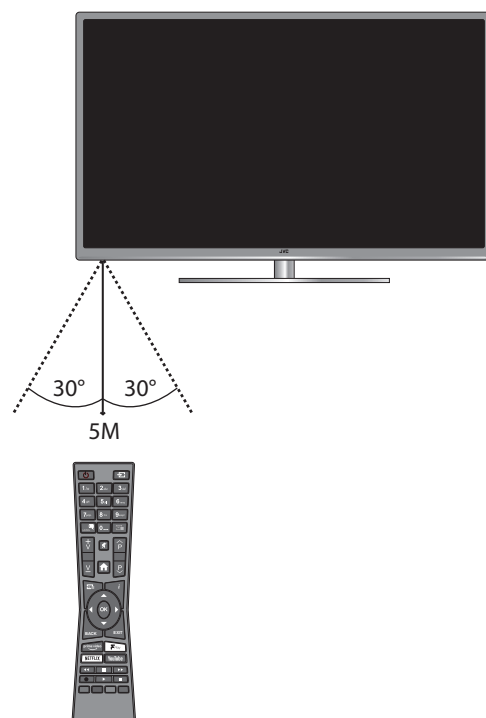

- Take care of your fingernails when you press and hold the battery release tab.
- Do not drop or cause impact to the remote control.
- Do not spill water or any liquid on the remote control.
- Do not place the remote control on a wet object.
- Do not place the remote control under direct sunlight or near sources of excessive heat.
- Remove the battery from the remote control when not in use for a long period of time, as it could cause corrosion or battery leakage and may result in physical injury and/or property damage including fire.

## Remote Control Operation Range

Point the remote control at the TV no more than 5 metres from the remote control sensor on the TV and within 60° in front of the TV. The operating distance may vary depending on the brightness of the room.



## Remote Control

1.  Switch the TV between on and standby mode.
2.  **SOURCE**  
Press to change the source you are viewing.  
TV - BACK AV - HDMI 1 - HDMI 2 - HDMI 3 - HDMI 4 - YPbPr - VGA/PC.
3. **0-9 Number Button**  
• Press to select a programme. (TV / RADIO mode)
4. **LANG.**  
Selects the Current Language menu.  
• Select Audio language or Subtitle language.
5.  Press to enter teletext if available.
6. **MUTE**  Mute and restore the sound.
7. **V + / -**  
Adjust the volume.
8. **P+ / P-**  
Press to select the next channel up or down the channel list.
9.  **HOME**  
Display the main menu.
10.  **(Programme Guide)**  
Press to view the Programme Guide.
11. **i (info)**  
Press to see programme information in TV mode.
12. **OK / ◀▶▲▼**  
• Press OK to select or save a setting in menus.  
• Press OK to select the Channel list while watching TV.  
• **◀▶▲▼** Allows you to navigate the OSD menus and adjust the system settings to your preference.
13. **BACK**  
Press to move backwards through menus.
14. **EXIT**  
Press to exit a menu.
15.  Press to enter Freeview Play (internet connection required).
16.  Press to enter prime video (internet connection required).

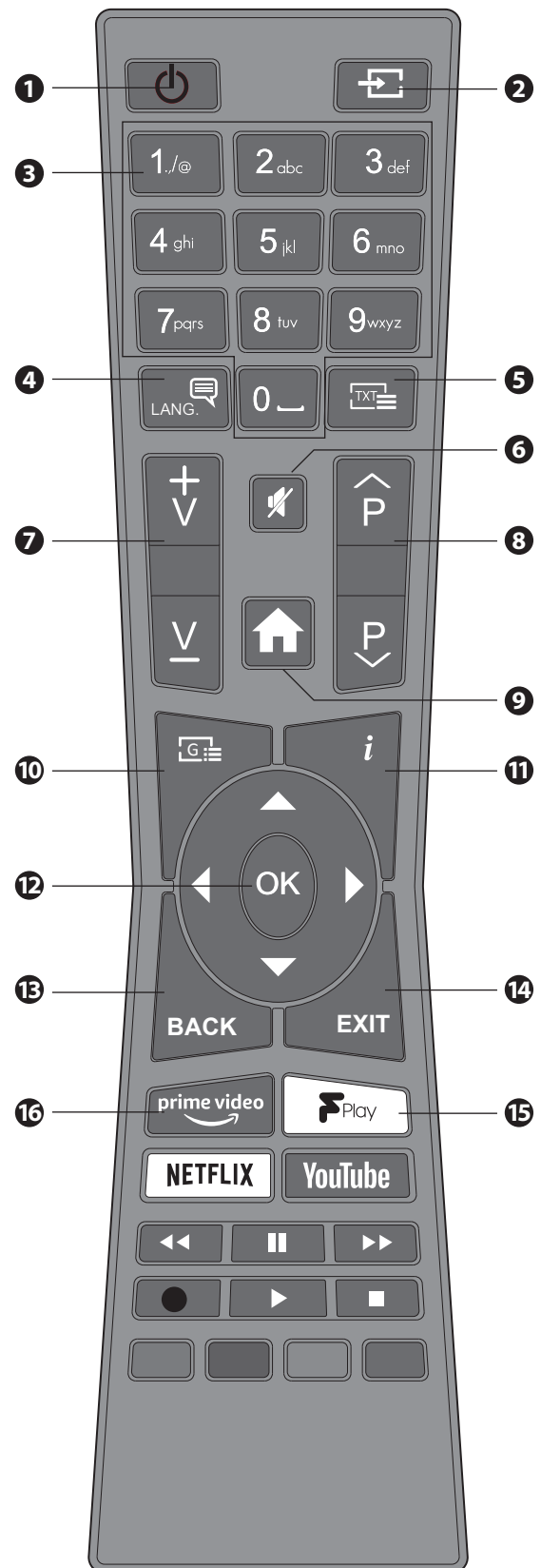

**17. NETFLIX Button**

Connects to Netflix for viewing online TV shows and films (internet connection required).

**18. YouTube**

Press to enter YouTube (internet connection required).

**19. PLAYBACK and RECORD buttons**

- starts a recording, continue to press will add more recordings.
- ▶ plays a recording.
- ⏸ pauses a recording and starts timeshifting in TV mode if you have a hard drive attached to the USB port.
- stops a recording.
- ◀▶▶ searches forwards and backwards when viewing a recording.

**20. COLOURED BUTTONS**

Access the TELETEXT items (TV mode) or menu options.

**TELETEXT (RED)**

Accesses TELETEXT.



## Turning the TV On for the First Time



Do not connect the TV to the mains supply until you have completed all the connections.

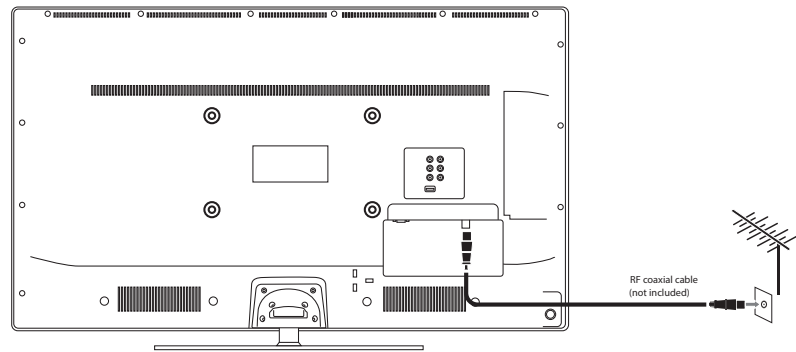

1. Connect one end of the RF coaxial cable to the aerial socket on the wall and the other end of the cable to the **ANT** socket on the back of your TV.
2. Plug the TV into a mains socket and switch on at the mains.
3. In standby mode, press the  button on the remote control to turn the TV on. The LED indicator will flash for a few seconds then the TV will switch on.



- Always disconnect the TV from the mains socket when not in use for a long period of time.
- The  button on the remote control is only used for switching the TV into standby, it does not disconnect the TV from the mains power. To completely disconnect the mains power, please remove the mains plug from the mains socket.

The first time you turn the TV on, it will go straight into the **First Time Installation** menu. Most of the settings are pre-set so you can just press **OK**. Please ensure the aerial is plugged in.

4. Press the     buttons to highlight your LANGUAGE then press **OK**.

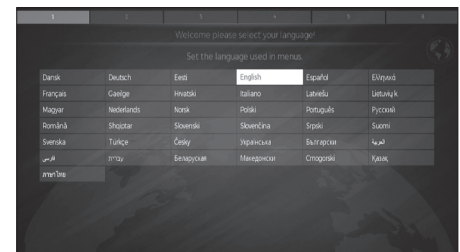

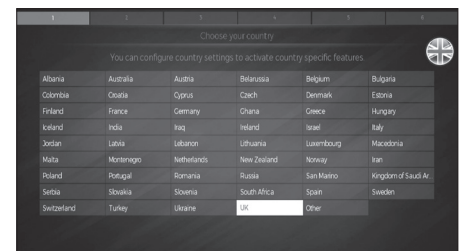

5. Press the     buttons to highlight your COUNTRY then press **OK**.

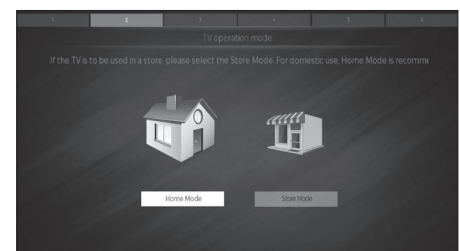

6. Select Home Mode by pressing the **OK** button.



7. Press the   buttons to highlight your desired picture mode. Its set to Natural as this is the most energy efficient mode. Then press **OK**.

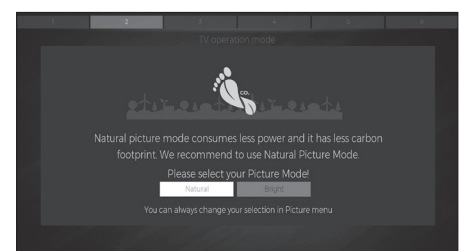

Before you are able to connect to the internet and use the smart features of your TV, you **MUST** make sure that some Privacy Settings are activated. This is part of the Initial Setup process or if you skip it, you can select them later by either pressing the **SMART** button where you'll be directed to the Privacy Settings menu or you can select the Privacy settings directly from Settings menu.

To use Smart functions the minimum settings that you will need to activate are **Portal and Applications** and **Internet connection**. For Red Button services you must activate **HbbTV**.

By activating these settings you are allowing the TV Manufacturer to store data to help improve the performance and user experience of your TV.

Each setting has a description, if you press the P  $\wedge$  /  $\vee$  button when the setting is highlighted you will be able to scroll up and down the text to read the description. To access all the features of your Smart TV you must be connected to the internet. If you do not wish to set up your network connection you can skip this section by pressing  $\blacktriangleright$ , however we recommend you set up your network connection now.

### To Accept ALL (recommended)

8. To accept all the setting press the **OK** button.

9. The 'Terms of Use' screen will appear. Press **OK** to accept the terms.

10. All of the boxed will now be ticked and NEXT will be highlighted, press **OK**.

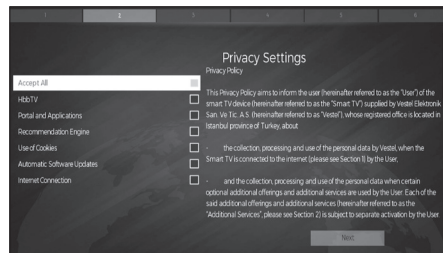

Press **OK** to Accept All

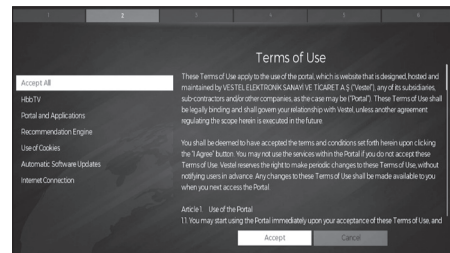

Press **OK** to Accept Terms of Use

### Select Individual Settings

If you don't want to accept all the setting you can choose to activate settings individually.

11. First make sure Accept All is deactivated.

12. Press the  $\blacktriangledown$  button to highlight your desired setting then press **OK** to activate it.

13. Press the  $\blacktriangledown$  button to highlight NEXT then press **OK**, a list will appear highlighting the settings that you haven't accepted. Select YES to continue.

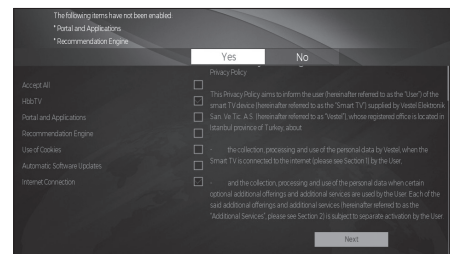
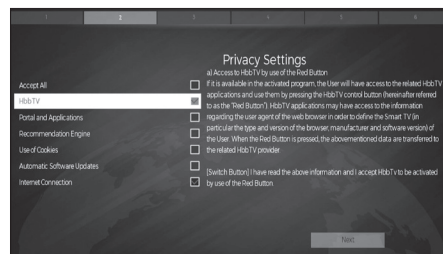

Reminder of setting not selected

### Choosing to Activate No Settings

14. If you **don't** wish to accept any of the settings press the  $\blacktriangledown$  button to highlight NEXT then press **OK**. You will be informed that you haven't enabled HbbTV and Portal and Applications. Select YES and press **OK**.

15. You're TV will now skip section 6 'Connecting to the Internet' and start to tuning. You will NOT have any smart functionality once your TV has tuned in. Select Yes and Press OK.

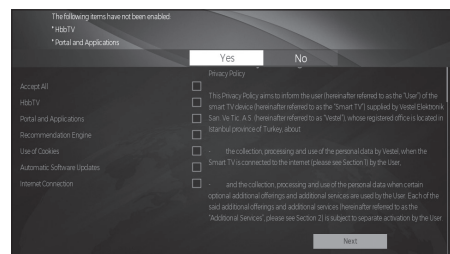

To enjoy Freeview Play and Smart functionality your TV must have enabled 'Portal and Applications' and 'Internet Connection' in the Privacy Setting and then connect to the internet.

### 3 Initial Setup

#### WIRED Connection

- If you have connected your ethernet cable to the LAN socket on the back of your TV, press the ▼ button to highlight NEXT then press OK.

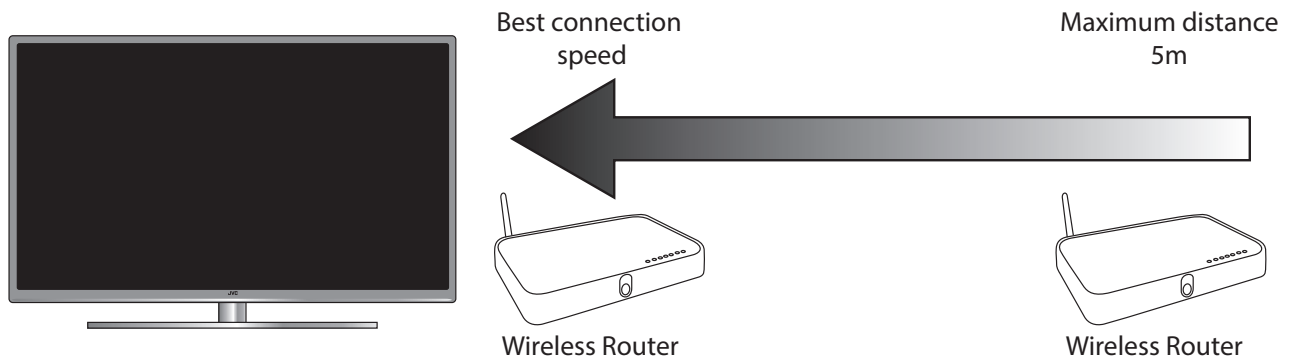
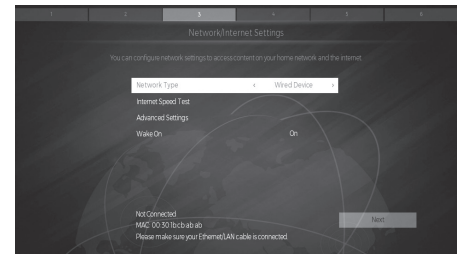

Make sure your TV is as close to your router as possible, within 5m and ideally in the same room as the TV

#### WIRELESS Connection

You can connect using a wireless connection via your router.

- Press the ◀▶ buttons to select WIRELESS DEVICE then press the ▼ button to highlight NEXT then press OK.

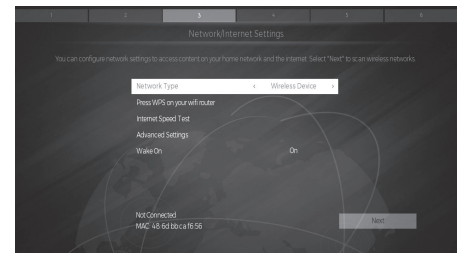

- Press the ▲▼ buttons to select your wireless network then press OK.



- You now need to enter your password, a keyboard will appear. Press the ◀▶▲▼ buttons to select a letter/number/symbol and press OK to enter each one. Once you have typed your password highlight OK and press OK.

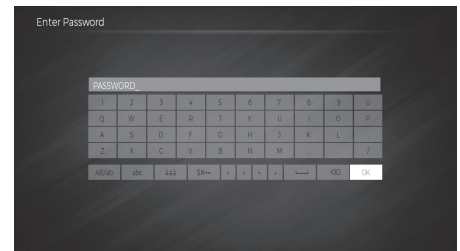

- The network will now show Connected and NEXT will be highlighted press the OK button to continue.

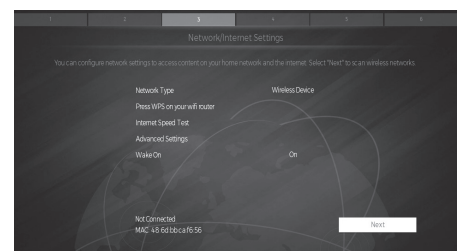



## WPS Connection

Rather than having to enter your Wireless password, you can select the WPS option. This will allow you to connect to your router without a password once the WPS button is pressed on your router.

20. Select WIRELESS DEVICE.

21. Press the ▼ button to highlight 'Press WPS on your wifi router' then press OK. Now press the WPS button on your router and your TV will connect to your router, without the use of a password.

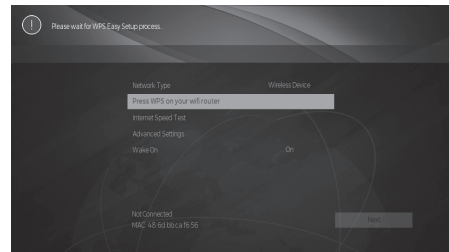

22. To make sure you activate Freeview Play select YES and press OK.



### If you View TV Through a Set Top Box

If you have attached a Set top box such as **Sky/Virgin** or **BT** via a HDMI cable then un-tick Digital Aerial and select NEXT. This will mean your TV will not try to tune any channels in. To view your set top box press the **HOME** button, scroll to **SOURCE** and select the HDMI socket you have attached your set top box to.

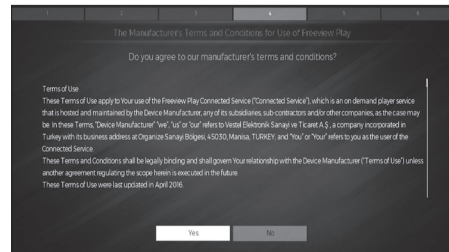

23. To tune in your TV using the aerial connection press OK.

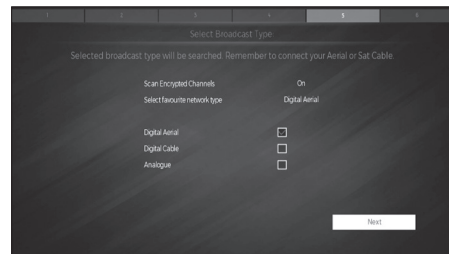

24. Your TV will now start automatic channel scan. It will tune in all available TV channels.

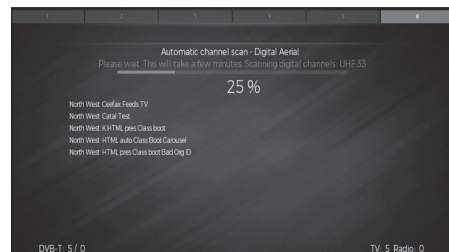

### 3 Initial Setup

#### Choose Region (UK only)

During tuning, your TV may have received signals from more than one transmitter. If this has occurred the Choose Region screen will be displayed. This will enable you to select the correct regional transmission for the local news service that you require.

- Press the ▼ button to highlight **Primary region**, then press the ◀▶ buttons to select your Primary Region e.g. England.
- Press the ▼ button to highlight **Secondary region**, then press the ◀▶ buttons to select your Secondary Region e.g. London.
- Press the ▼ button to highlight **Tertiary region**, then press the ◀▶ buttons to select your Tertiary Region e.g. Greater London.
- Press the ▼ button to highlight Save then press **OK**.

Your TV is now fully tuned in.

<b>Country Code</b>	This will be shown as UK.
<b>Primary Region</b>	This will show the regional country (England, Wales, Scotland, NI).
<b>Secondary Region</b>	This will allow you to set the region for your local news service on BBC and ITV (London, Beds and Cambs etc).
<b>Tertiary Region</b>	You may receive signals from more than one transmitter within the Secondary Region, (e.g Beds and Cambs may have Luton or Sandy Heath).

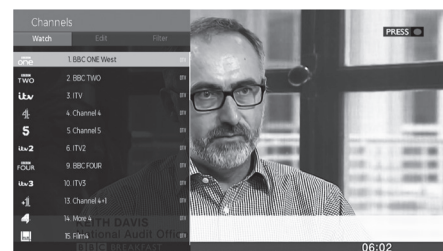
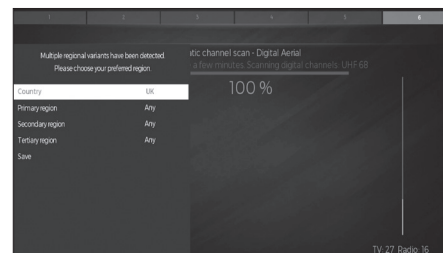

**25.** The Scan statistics screen will now be displayed. This shows the amount of TV and Radio channels that have been tuned in. Press **OK** to exit.

**26.** The Edit Channel list will appear, press the **EXIT** button to remove this. Your TV is now fully tuned in and ready to use.

## Connecting an Analogue Device

If you have connected an analogue device such as a video recorder via the aerial socket on your TV you will have to tune it in using **Analogue** mode. Ensure the device is switched on before you start the tuning process.

1. Press the **MENU** button, press the ◀▶ buttons to select **INSTALL AND RETUNE** and press **OK**.
2. Select **AUTOMATIC CHANNEL SCAN (RETUNE)** and press **OK**.
3. Press the ▲▼ buttons to select **ANALOGUE** and press **OK**.
4. Press the ◀▶ buttons to select **YES** then press **OK**. The search will automatically start, this will not delete your Digital channels, so don't worry!
5. When the search has finished the **EDIT CHANNEL LIST** will appear. Your analogue channel will be at the end of the channel list.

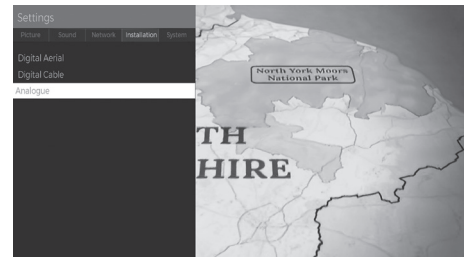

### 3 Initial Setup

## Channel Selection

- Press the **P + / -** buttons on the remote control repeatedly or the **0-9** buttons to select the channel.



### Alternative

Press the **OK** button to enter the **Channel List**. Then use the **▲▼** buttons to highlight and select the channel. Press the **OK** button to view the selected channel.

OR

Press the **i** (info) button then the **▲▼** buttons to search for a channel you wish to watch then press **OK**.

- If a locked channel is selected, the password screen will be displayed. Press the **0-9** buttons to enter the password, the channel will then be unlocked (refer to **Locking Channel** for details).

## Display Channel Information

- Press the **INFO** button to view the current channel.
- Press the **INFO** button a second time to see information about the current programme you're viewing.
- Press the **▶** button to see programme information for the next programme.
- Press **INFO** to remove the information.



Current Programme Information



Next Programme Information

## Volume Adjustment

- Press the **V +** or **-** button on the remote control or rotate the multi-function switch up or down on the back of the TV.
- If you wish to switch the sound off, press the **MUTE** button. You can turn the volume down while your TV is in mute mode. Press the **VOL -** button, you will see the volume level reduce, but you won't hear anything at the moment. To listen to your TV at the new lower level, press the **MUTE** button again or **VOL +** button.

## Using the buttons on the back of the TV

The button on the back of the TV is like a joystick you can push the centre and move it left, right, up and down.

- Press and hold the **POWER** button to switch the TV in and out of **STANDBY**.
- Press the **POWER** button to access the **SOURCE** menu, press the **▲/▼** buttons to move up and down the menu. Press **POWER** to select a source.
- Press the **▲/▼** buttons to change channel.
- Press the **+/-** buttons to adjust the volume.

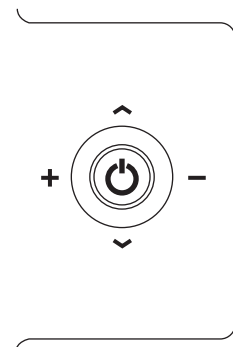

## Adjusting the Picture Settings

Allows you to set your preferred picture mode.

1. Press the **HOME** button.



2. Press the **▲▼** buttons to select the **SETTINGS** and then press the **▶** button to highlight **PICTURE**.

You'll see that 3 picture common options, **MODE**, **ENERGY SAVING** and **PICTURE ZOOM** appear above the menu. To select these options press the **▲** button then the **▶** button to highlight the option then press **OK**. Then press the **◀▶** to select your desired setting.



### Common Picture Options

<b>Mode</b>	Your TV has some pre-set picture modes: Dynamic - Natural - Cinema - Game. The default setting is Standard. You can also manually adjust each mode.
<b>Energy Saving</b>	The energy saving mode can be adjusted from Custom - OFF - Minimum - Medium - Maximum - Auto - Screen Off. Adjusting this setting will reduce the brightness and power consumption of your TV or turn the screen off altogether.
<b>Picture Zoom</b>	Adjusts the aspect ration of the picture. AUTO - 16:9 - SUBTITLE - 14:9 - 14:9 Zoom - 4:3 - CINEMA.

## 4 Customising TV Settings

- Highlight PICTURE then press the **OK** button.

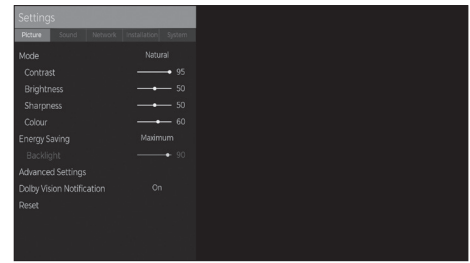

- Press the ◀▶ buttons to adjust the levels in the menus.

<b>Mode</b>	Your TV has some pre-set picture modes: Dynamic - Natural - Cinema - Game. The default setting is Standard. You can also manually adjust each mode.	
<b>Contrast</b>	Adjusts the difference between light and dark levels in the picture.	
<b>Brightness</b>	Increases or decreases the picture brightness.	
<b>Sharpness</b>	Adjusts the level of crispness in the edges between light and dark areas of the picture.	
<b>Colour</b>	Controls the colour intensity.	
<b>Energy Saving</b>	The energy saving mode can be adjusted from Custom - OFF - Minimum - Medium - Maximum - Auto - Screen Off. Adjusting this setting will reduce the brightness and power consumption of your TV or turn the screen off altogether.	
<b>Backlight</b>	Adjusts the backlight setting. Only available when Custom Energy Saving is selected above.	
<b>Advanced Picture Settings</b>	Select to have more advanced adjustments to your TV's picture.	
<b>Dolby Vision Notifications</b>	<b>Dynamic Contrast</b>	Adjusts the contrast to pre-set levels. OFF - LOW - MEDIUM - HIGH
	<b>Noise Reduction</b>	Reduces the noise level of the connected device: Off / Low / Middle / High.
	<b>Colour Temp</b>	Adjusts the colour temperature. NORMAL - WARM - COOL
	<b>Picture Zoom</b>	Adjusts the aspect ratio of the picture. AUTO - 16:9 - SUBTITLE - 14:9 - 14:9 Zoom - 4:3 - CINEMA.
	<b>Film Mode</b>	Film mode can be switched to AUTO or OFF. Auto mode will adjust the frame rate to produce the clearest motion.
	<b>Skin Tone</b>	Adjusts the skin tone from -5 to 5.
	<b>Colour Shift</b>	Select to adjust the picture colour between Red and Green.
<b>Dolby Vision Notifications</b>	You can switch Dolby Vision Notifications on or off. When the notification is on, if you press the Info button it will show if you are watching HDR content.	

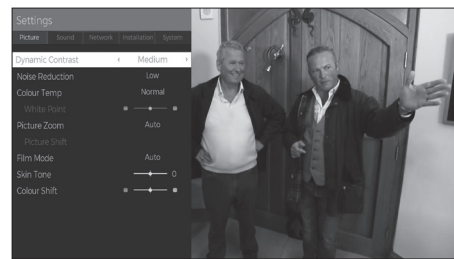

- Press the **BACK** button to return to the previous menu.
- Press the **EXIT** button to exit the menu.

## Adjusting the Sound Settings

Allows you to adjust the sound settings on your TV.

1. Press the **HOME** button.



2. Press the **▲▼** buttons to select the **SETTINGS** and then press the **▶** button to highlight **SOUND**.

You'll see that 3 picture common options, **EQUALIZER** and **SPEAKERS** appear above the menu. To select these options press the **▲** button then the **▶** button to highlight the option then press **OK**. Then press the **◀▶** to select your desired setting.

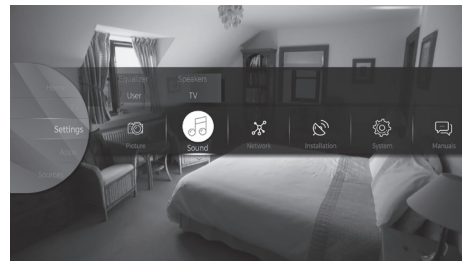

### Common Sound Options

<b>Equalizer</b>	Selects pre-set equalizer modes. Highlight the equalizer mode then press <b>OK</b> to enter the <b>EQUALIZER SETTINGS</b> menu. The equalizer modes are: <b>MOVIE - SPEECH - FLAT - CLASSIC - USER - MUSIC</b> .
<b>Speakers</b>	Selects <b>SPEAKER</b> or <b>AMPLIFIER</b> . If you have connected a Soundbar to your TV via HDMI you will need to select <b>AMPLIFIER</b> so the sound comes out of the Soundbar and not the TVs speakers.

## 4 Customising TV Settings

- Highlight **SOUND** then press the **OK** button.



- Press the ◀▶ buttons to adjust the levels in the menus.

<b>Volume</b>	Adjusts the volume level.
<b>Equalizer</b>	Selects pre-set equalizer modes. Highlight the equalizer mode then press <b>OK</b> to enter the EQUALIZER SETTINGS menu. The equalizer modes are: MOVIE - SPEECH - FLAT - CLASSIC - USER - MUSIC.
<b>Balance</b>	Adjusts the sound level from the left and right speakers.
<b>Headphone</b>	Adjusts the volume level when listening to the TV with headphones. To prevent damaging your hearing set the volume level low and gradually increase the level until you're happy.
<b>Sound Mode</b>	Selects the sound modes. STEREO - DUAL I - DUAL II.
<b>AVL (Automatic volume limiting)</b>	AVL will set the sound level so that its the same across all programmes. So when you change channels the sound level won't change. Set AVL to ON or OFF. You will also find more options when Dolby Audio is set to SMART, MOVIE, MUSIC or NEWS. You will also be able to select NORMAL, NIGHT or AUTO in AVL options. NORMAL is the same as it just being switched ON with Dolby Audio in the OFF positon. Night will reduce the audio levels slightly so not to disturb people at night. AUTO will set the audio levels depending on the time of day. Between 10pm and 7am it will switch to the NIGHT level which is a lower level.
<b>Headphone/lineout</b>	Changes output between Headphone and lineout. Choose 'Headphone' when connecting headphones and 'Lineout' when connecting an audio device to your Headphone socket.
<b>Dynamic Bass</b>	Switches Dynamic bass ON and OFF.
<b>Dolby Audio</b>	Dolby Audio has preset sound settings. The default setting is SMART. The setting are SMART - MOVIE - MUSIC - NEWS and OFF. They are designed to give you the best sound quality for the content that you are viewing. If you select SMART this will automatically detect the content you're watching and adjust the audio settings accordingly. Selecting SMART, MOVIE or NEWS will enable you to also select more options in AVL. You'll be able to select NORMAL, NIGHT and AUTO in the AVL menu.
<b>DTS TruSurround</b>	Surround Sound can be switched ON or OFF. When switched on you will hear a more spacious sound, to make you feel more immersed in the action on your TV. If Dolby Audio is switched on, DTS TruSurround will be automatically switched off and not selectable in the menu.
<b>Digital Out</b>	Sets the digital audio out type to PCM or COMPRESSED.

- Press the **BACK** button to return to the previous menu.
- Press the **EXIT** button to exit the menu.



## Editing the Channel List

You can add channels to your home menu, delete, lock, add favourites, or tag channels in the EDIT CHANNEL LIST menu.

1. Press the **OK** button and then press the **►** buttons to select **Edit** and then press the **OK** button. The EDIT menu will now be displayed.

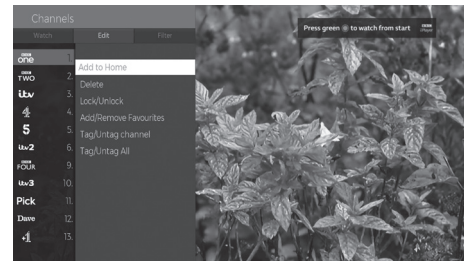

<b>Add to Home</b>	<ol style="list-style-type: none"> <li>1. Press the <b>▲▼</b> buttons to select the channel that you wish to add to your home menu.</li> <li>2. Press <b>OK</b>, then press the <b>▲▼</b> buttons to select ADD TO HOME then press <b>OK</b>. The channel will now be added onto the home menu bar.</li> </ol>
<b>Move</b>	<ol style="list-style-type: none"> <li>1. Press the <b>▲▼</b> buttons to select the channel that you wish to move.</li> <li>2. Press <b>OK</b>, then press the <b>▲▼</b> buttons to select MOVE then press <b>OK</b>.</li> <li>3. Press the <b>NUMBER</b> buttons to enter the channel number that you want to move the channel to, then press <b>OK</b>.</li> <li>4. Select YES and press <b>OK</b>. The channel will now have moved positions in the channel list.</li> </ol>
<b>Delete</b>	<ol style="list-style-type: none"> <li>1. Press the <b>▲▼</b> buttons to select the channel that you wish to delete.</li> <li>2. Press <b>OK</b>, then press the <b>▲▼</b> buttons to select DELETE then press <b>OK</b>.</li> <li>3. Select YES and press <b>OK</b>. The channel will be deleted. To get the channel back you will need to tune your TV in again.</li> </ol>
<b>Edit name</b>	<ol style="list-style-type: none"> <li>1. Press the <b>▲▼</b> buttons to select the channel that you wish to change the name of.</li> <li>2. Press <b>OK</b>, then press the <b>▲▼</b> buttons to select EDIT NAME then press <b>OK</b>.</li> <li>3. A keyboard will appear press <b>▲▼◀▶</b> buttons to enter the new name of the channel, then select OK press <b>OK</b>.</li> </ol>
<b>Lock/Unlock</b>	<ol style="list-style-type: none"> <li>1. Press the <b>▲▼</b> buttons to select the channel that you wish to lock.</li> <li>2. Press <b>OK</b>, then press the <b>▲▼</b> buttons to select LOCK/UNLOCK then press <b>OK</b>.</li> <li>3. Press the <b>NUMBER</b> buttons to enter your PIN number. The lock symbol will appear next to the channel. To view the locked channel you will now have to enter your PIN number.</li> </ol>
<b>Add/Remove Favourites</b>	<ol style="list-style-type: none"> <li>1. Press the <b>▲▼</b> buttons to select the channel that you wish to add or remove from your favourites.</li> <li>2. Press <b>OK</b>, then press the <b>▲▼</b> buttons to select ADD/REMOVE FAVOURITES then press <b>OK</b>.</li> <li>3. Press the <b>▲▼</b> buttons to select the list you want to add the channel into.</li> <li>4. Press the <b>◀▶</b> buttons to select YES or NO, then press <b>OK</b>. The list number will now appear next to the channel number to show its been added to your favourites.</li> </ol>
<b>Tag/Untag Channel</b>	<p>You can tag and individual channel or multiple channels, which you can then move, lock or delete all in one go. You can move a maximum of 10 channels at once.</p> <ol style="list-style-type: none"> <li>1. Press the <b>▲▼</b> buttons to select the channel that you wish to tag then press <b>OK</b>. A tick will appear next to the channel. You can tag more than one channel at a time, just use the same process.</li> <li>2. Press BACK, the EDIT menu will appear, you can now choose if you want to Move or Delete the tagged channels</li> </ol>
<b>Tag/Untag All</b>	<p>You can tag all channels, which you can then delete or lock all in one go.</p> <ol style="list-style-type: none"> <li>1. Press <b>OK</b>, then press the <b>▲▼</b> buttons to select the TAG/UNTAG ALL. A tick will appear next to all the channels.</li> <li>2. Press <b>OK</b>, then press the <b>▲▼</b> buttons to select DELETE or LOCK then press <b>OK</b>.</li> </ol>

### Filtering the Channel List

You can filter the channel list to tailor the list to your personal preference. You can filter by Channel Type, TV/Radio stations, Free/Pay channels, HD/SD channels or your Favourite channels.

1. Press the **OK** button and then press the **►** buttons to select **Filter** and then press the **OK** button. The FILTER menu will now be displayed.

<b>Channel Type</b>	Press <b>►</b> to select ALL - DIGITAL AERIAL - DIGITAL CABLE - ANALOGUE TV ONLY.
<b>TV/Radio</b>	Press <b>►</b> to select TV ONLY - RADIO ONLY.
<b>Free/Pay</b>	Press <b>►</b> to select FREE - ENCRYPTED - ALL.
<b>HD/SD</b>	Press <b>►</b> to select ALL - SD - HD.
<b>Favourites</b>	Press <b>►</b> to select NONE - 1 - 2 - 3 - 4.
<b>Profile Options</b>	Not available in the UK.
<b>Reset</b>	Press OK to reset all the options.

### Viewing your Favourite Channel List

You can set up 4 different favourite lists.





1. While watching TV press **OK** button. The channel list will appear.
2. Press the **►** button to highlight the FILTER and press **OK**.
3. Press **▼** button to select FAVOURITES, then press the **◀▶** buttons to select the favourite list 1-4 that you want to view and press **OK**. The channel list will now just show you your favourite channels.
4. To watch a channel in your favourites list either select the WATCH tab or press the P+/P- buttons.

To see the full list of channels again select NONE under Favourites.



## Home Menu

Its possible to Move, Add and delete items on the Home menu bar, so its perfect for you. The Home menu bar has the most popular apps installed on it but you can also add to this bar. You can add your favourite channel, source or other apps from the JVC Market on your TV.

### Moving an item on the Home Menu bar

1. Press the  HOME button.
2. Press the  buttons to select an item on the bar.
3. Press the  button you'll see two options appear, Delete and Move.
4. Press the  to highlight MOVE then press **OK**. A red box will appear around the item.
5. Press the  buttons to move the item to a new location on the menu bar and then press **OK** to confirm its new location.

### Deleting an item on the Home Menu bar





1. Press the  HOME button.
2. Press the  buttons to select an item on the bar that you wish to delete.
3. Press the  button you'll see two options appear, Delete and Move.
4. DELETE is already highlighted, press **OK**. The selected item will be deleted. Don't worry its only deleted from the Home Menu bar its still on the TV, it can always be added back on.

### Adding an item to the Home Menu bar





You can add Apps, Channels or Sources to the Home Menu bar.

#### Adding an App

To add an app to your Home Menu bar it must first be available on the APPS screen. So if you want to add an app that's in the MARKET, it first needs to be added to the APPS screen.

1. Press the  HOME button.
2. Press  to select APPS, press  to highlight ADD MORE and then press **OK**. You'll see the APPS screen, here you find all the apps that are installed on your TV, or you can select the app in the top left corner and this will show you the MARKET. In the MARKET you can download more apps to your APPS screen of your TV.
3. Highlight the APP that you wish to add from the APPS screen, then press **OK**. You'll see 3 options. Press the  button to select ADD TO HOME then press **OK**. It will now be added to the Home Menu bar.

#### Adding a Source

1. Press the  HOME button.
2. Press  to select SOURCES, press  to highlight the source you wish to add, then press the  button, you see ADD To HOME then press **OK**. The Source will now be added to the Home Menu bar.

#### Adding a Channel

1. While watching the channel you want to add press the **OK** button.
2. Select the EDIT tab and then scroll down to ADD TO HOME and then press **OK**. The channel will now be added to the Home Menu bar.

## Programme Guide



This system has a Programme Guide to help you navigate through all the possible viewing options.

The Programme Guide supplies information such as programme listings, start and end times for all available services. In addition, detailed information about the programme is often available in the Programme Guide (the availability and amount of programme information will vary, depending on the particular broadcaster).



This function can be used only when the Programme Guide information is broadcast by broadcasting companies.

The Programme Guide displays the programme details for the next 7 days.

### Switch On / Off Programme Guide

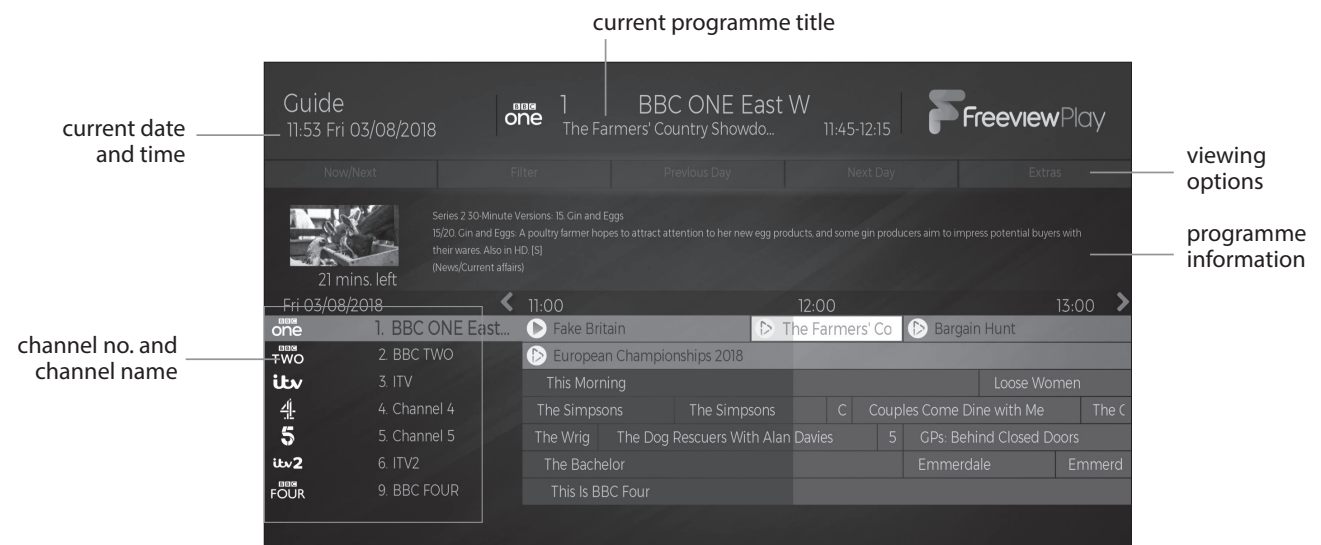
1. Press the  button to view the Programme Guide.
2. Press the  button or the **EXIT** button again to switch off Programme Guide and return to normal TV viewing.



- When you scroll back through the Programme Guide if you see a  next to a programme name this shows you can watch the programme. Press **OK** to watch the programme. If you see a  this shows that the programme is going to be available to watch later.

### Select a Programme

Press the **▲▼◀▶** buttons to select the desired programme. Press the **OK** button to confirm. Then press the **▼** to highlight **SELECT CHANNEL** and press **OK**.

### Record a Programme

Press the **▲▼◀▶** buttons to select the programme you wish to record then press the **●** (RECORD) button. The record symbol will appear next to the programme to show its set to record. Remember you must have a Hard Drive or USB stick connected to your TV, otherwise the programme won't record.



### Viewing options

You can change the way the programme guide looks to help you find your programmes easily and quickly. To select the options press **BACK** button to move up to the options. Then scroll across using the ◀▶ buttons to highlight your desired viewing option then select it by pressing **OK**.

Option	Function
<b>NOW/NEXT</b>	Select to view a list of current programmes and the next programmes.
<b>FILTER</b>	Select the FILTER. Here you can filter the Programme Guide to make it easier to find your programmes. <ul style="list-style-type: none"> <li>• <b>Channel Type</b> - DIGITAL AERIAL - DIGITAL CABLE</li> <li>• <b>TV/Radio</b> - Filter ALL - TV ONLY - RADIO ONLY - TEXT ONLY.</li> <li>• <b>Free/Pay</b> - Filter ALL - FREE - ENCRYPTED</li> <li>• <b>HD/SD</b> - Filter for High Definition or Standard Definition.</li> <li>• <b>Favourites</b> - NONE - FAVOURITES 1 - 2 - 3 - 4</li> <li>• <b>Reset</b> - Will reset all the filter options</li> </ul>
<b>PREVIOUS DAY</b>	Select PREVIOUS DAY then press <b>OK</b> to go back to the previous days programmes.
<b>NEXT DAY</b>	Select NEXT DAY then press <b>OK</b> to go forward to the next days programmes.
<b>EXTRAS</b>	Select EXTRAS to see more viewing options. <ul style="list-style-type: none"> <li>• <b>Highlight Genre</b> - Select a genre from the list and all programmes from that genre will be highlighted in the guide.</li> <li>• <b>Guide Search</b> - Select search to be able to type in the name of the programme you're looking for.</li> <li>• <b>Now</b> - Select Now to see all the programmes that start now.</li> <li>• <b>Zoom</b> - Select zoom to condense the time gaps by 30 minutes each press to see more programmes on the screen.</li> </ul>

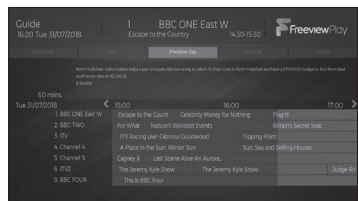
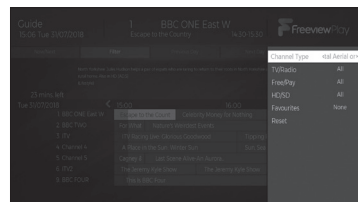
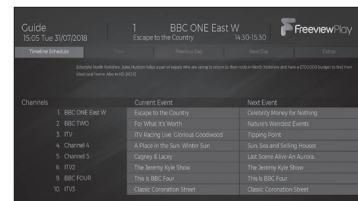

## Time Shift Recording onto a USB Storage Device

This function allows you to pause live TV. The picture will pause and the programme will begin recording so you don't miss any of the programme. You will have to have a USB storage device attached to the USB socket for Time Shift Recording to work.



- Time Shift Mode and Recording functions may not work if the signal strength is weak.
- Stop the time shift function before switching to another input source.



If the transfer rate of the USB storage device is too slow for recording or time shift function, a warning statement will be shown on the screen. If this happens, please upgrade your USB storage device. The minimum transfer speed is 5MB/s.

While watching your TV, you may press the **||** button to pause the live programme if you want to go out for a while (e.g. going to the bathroom / kitchen). "**||**" will show on the screen.

When you have returned, press the **▶** (PLAY) button to play the missed broadcast programme. "**▶**" will briefly show on the screen.

The video and sound may have a little bit of delay or be out-of-sync for a few seconds when the unit starts to playback the missed programme. It will soon turn to normal.



### The 'PVR Time Shift Progress Bar'

- 1 Indicates the status of the currently displayed video (▶ / || / ◀◀ / ▶▶)
- 2 Channel and Programme name being recorded.
- 3 Indicates the amount of time recorded.

## Using the Remote Control

You can shift playback to any point of the virtually recorded programme.

◀◀ or ▶▶	When playing, <ul style="list-style-type: none"> <li>• Press the ▶▶ button repeatedly to speed up - x 2 / x 4 / x 8 / x 16 / x 32.</li> <li>• During fast forward press the ▶ (PLAY) button to return to normal playback.</li> </ul> When paused <ul style="list-style-type: none"> <li>• Press the ▶▶ button repeatedly to view in slow motion - x 1/4 / x 1/2 / x 1 (normal playback).</li> </ul>
	<ul style="list-style-type: none"> <li>• During playback, press the    button to display a still screen and then press the    button again or the ▶ (PLAY) button to resume playback.</li> </ul>
OK	When timeshifting press the OK button to play or pause the recording.
■	If you want to exit timeshifting, press the ■ button.

## Recording DTV Programmes onto a USB Storage Device

Use this function to record the DTV programme you are watching on the main screen and save it for future viewing.

The recording from timer programme or direct recording may have a little bit of delay when it starts to record the broadcast programme.

Please make sure the USB device is inserted. If not, a warning message will pop up. You can only record the programme that you are currently watching.

1. Press the **●** button to record the programme that you are currently watching.



The recording screen will briefly appear. It will display the channel and programme name and the minutes of that programme left.



2. To stop a recording press the **■** button, then select YES and press **OK**.



Recording will stop automatically when the disk is full.



You can turn off the TV while recording. Press the **⏻** button. The standby indicator light will flash to show the TV is still recording.

## Setting a Timer or Timed Recording

This function is used to perform scheduled recordings or timers (will switch the programme on when it starts).

The recording from timers or direct recording may have a little bit of delay when it starts to record the broadcast programme.

Please make sure the USB device is inserted. If not, a warning message will pop up.

1. Press the **HOME** button then press the **▼** buttons to select TV. Press **▶** to highlight TIMERS and press **OK**.

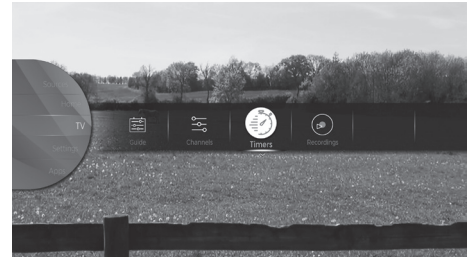

The TIMERS menu will now be displayed, if you have already set some other recordings you'll see them here.

2. ADD TIMER will be selected, press **OK**. The ADD TIMER menu will be displayed.

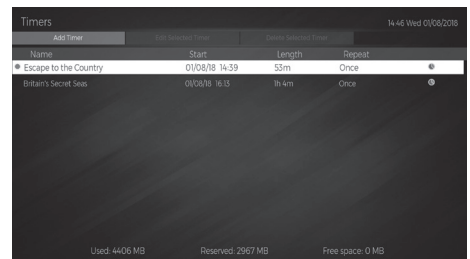

### 3. Adding the timer

Press the **▲▼** to select each setting below.

<b>Channel Type</b>	Press the <b>◀▶</b> buttons to select the channel type that you want to set a timer for. ALL - Will allow you to select any channel DIGITAL AERIAL - Will only let you select channels from your aerial.
<b>Timer Type</b>	Press the <b>◀▶</b> buttons to select RECORD or TIMER. RECORD - Will record a programme TIMER - Will automatically switch to the selected programme when it starts.
<b>Channel</b>	Press the <b>◀▶</b> buttons to select the channel.
<b>Record Type</b>	Not adjustable.
<b>Date</b>	Press the <b>◀▶</b> buttons and the NUMBER buttons to set the date.
<b>Start</b>	Press the <b>◀▶</b> buttons and the NUMBER buttons to set the start time.
<b>End</b>	Press the <b>◀▶</b> buttons and the NUMBER buttons to set the end time.
<b>Duration</b>	Set automatically.
<b>Repeat</b>	Press the <b>◀▶</b> buttons to set the recording to record ONCE - DAILY - WEEKLY or just WEEKDAYS.
<b>Change/Delete</b>	Press the <b>◀▶</b> buttons to select ALLOWED or DISALLOWED ALLOWED - You allow anyone to change or delete the recording. DISALLOWED - You will have to enter the PIN code to change or delete the recording.
<b>Playback</b>	Press the <b>◀▶</b> buttons to select USE PARENTAL SETTINGS, DISALLOWED or ALLOWED. You will need to enter the PIN number if you want to play a recording when you select 'use parental settings and disallowed'.

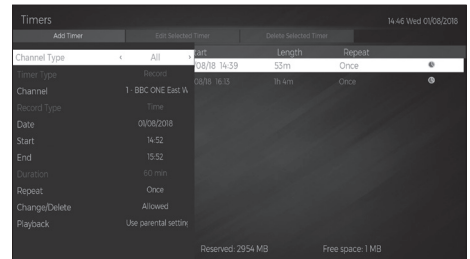

- When the preset time is reached, the TV will start recording automatically.
- If a programme recording starts when the TV is in standby mode, the LED indicator will flash.



## Editing a Timer

If you need to change any of the setting in a TIMER then you can do this in the EDIT SELECTED TIMER tab at the top of the Timers screen.

1. With the TIMERS screen displayed press the ► button to select the EDIT SELECTED TIMER tab at the top of the screen.
2. Press the ▲▼ buttons to select the timer that you would like to edit then press **OK**.
3. You can now edit all the settings, press **OK** to save your new settings.

## Deleting a Timer

1. With the TIMERS screen displayed press the ► button to select the DELETE SELECTED TIMER tab at the top of the screen.
2. Press the ▲▼ buttons to select the timer that you would like to delete then press **OK**.
3. You'll now be asked if you want to delete this timer, select YES then press **OK**. The timer will now be deleted.

## Playing Recorded Programmes

All of your recording are stored in RECORDINGS.  
HOME - TV - RECORDINGS

1. Press the **HOME** button then press the **▼** buttons to select TV. Press **▶** to highlight RECORDINGS and press **OK**.

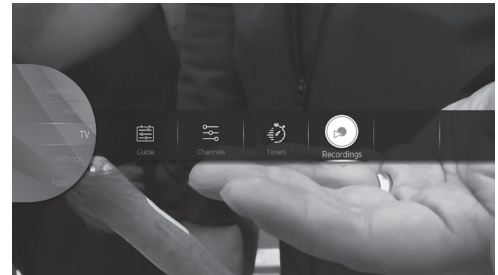

2. The RECORDING menu will be displayed. Press the **▲▼** buttons to select the recording that the want to watch then press **OK**.

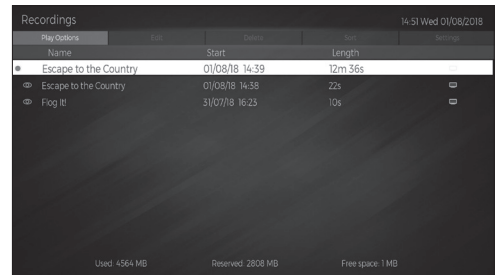

3. The OPTIONS menu will appear, you can choose to play the recording from the start, resume playing from the last time you watched the recording or play from offset. This is where you can start the recording at a selected time from the start.

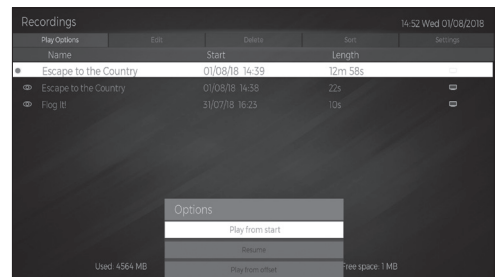

## Editing a Recording

In the EDIT tab you can edit some of the recording options. You can change the Delete settings and Playback setting. Here you can allow or disallowed other users to delete or play the recording.

1. With the RECORDINGS screen displayed press the **▶** button to select the EDIT tab at the top of the screen.
2. Press the **▲▼** buttons to select the recording that you would like to edit then press **OK**.
3. You can now edit all the settings, select SAVE and press **OK** to save your new settings.

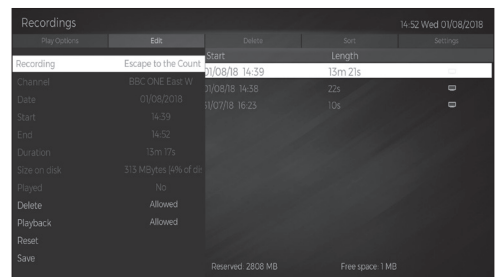

## Deleting a Recording

1. With the RECORDINGS screen displayed press the **▶** button to select the DELETE tab at the top of the screen.
2. Press the **▲▼** buttons to select the recording that you would like to delete then press **OK**.
3. You'll now be asked if you want to delete this recording, select YES then press **OK**. The recording will now be deleted.

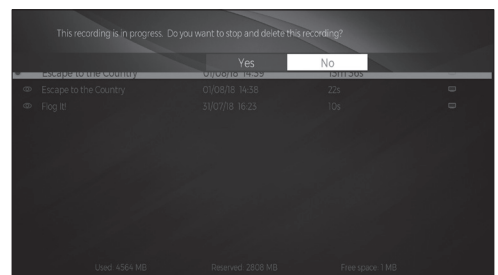

## Sorting a Recordings

1. With the RECORDINGS screen displayed press the ► button to select the SORT tab at the top of the screen then press **OK**.
2. The Sort By menu will be displayed. Press the ▲▼ buttons to select sort by:  
Name - Name, Reversed - Start, Oldest First - Start, Newest First - Length, Shortest First - Length, Longest First - Unviewed First - Viewed Last.

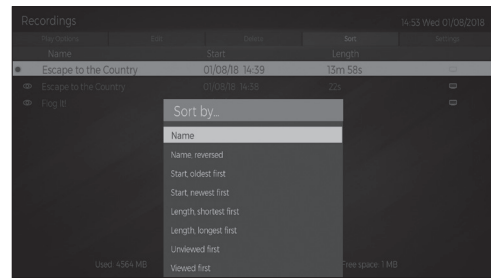

## Recording Settings

The recording settings menu allows recording adjustment. You can add time to the start and end of each recording and set and maximum recording time for timeshifting.

You can also select how you want your TV to automatically delete your recordings so you won't run out of space on your USB storage device.

1. Press the **HOME** button then press the ▼ buttons to select TV. Press ► to highlight RECORDINGS and press **OK**.

The RECORDINGS menu will now be displayed, if you have already made some recordings you'll see them here.

2. Press ► to highlight SETTINGS and press **OK**. The Recording settings menu will be displayed.
3. Press the ▲▼ to select each setting below.

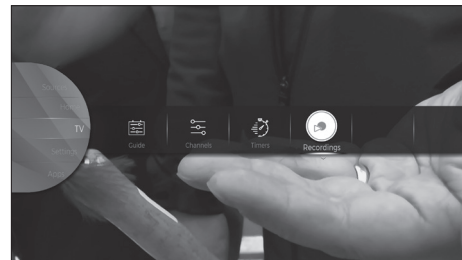

<b>Start early</b>	Press the ◀▶ buttons to select an amount of time you would like the recording to start before the programme starts (max 10 mins).
<b>End late</b>	Press the ◀▶ buttons to select an amount of time you would like the recording to end after the programme finishes (max 10 mins).
<b>Max Timeshift</b>	Press the ◀▶ buttons to select a maximum amount of time you would like the timeshift recording to record (from 10 mins to 2 hours).
<b>Auto discard - Discard</b>	Press the ◀▶ buttons to select the recording that you want to automatically delete when the USB storage device is full. NONE - OLDEST - LONGEST - SHORTEST
<b>Auto discard - Unplayed</b>	Press the ◀▶ buttons to select to delete the played or unplayed recordings.
<b>Hard disk information</b>	Select to see the Hard disk information.
<b>Format Disk</b>	Select to format the USB storage device, you will need to enter your PIN number. Any previous recordings will be deleted.



## Red Button + (Interactive services)

Red button + services are available on BBC TV and Radio channels. The services are gradually changing to an internet based service rather than the conventional over air (though your aerial). To make the most out of the Red Button + services make sure your TV is connected to the internet. You can also access BBC iPlayer through RED button +.

### Accessing the Information

- In DTV mode press the **TXT** button to display the main information page. You may see slightly different looking pages depending if your TV is accessing the page over air or via the internet.

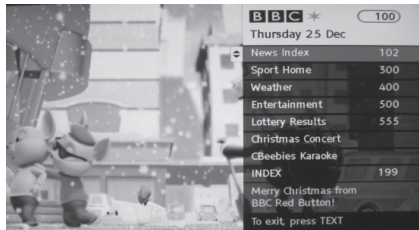

Over Air Red Button + Services



Internet Red Button + Services

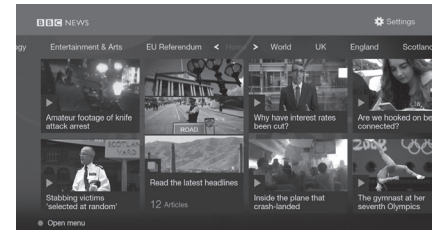

iPlayer via the Red Button + Services

- Follow the instructions on the interactive services page and move around the page by pressing **▲****▶****▼**, **OK**, **RED**, **GREEN**, **YELLOW**, **BLUE** or **0-9** buttons etc.

To change digital teletext services, you will need to exit the current text service and change channels. Then enter the text service on the newly selected channel.



#### Alternative

You may press the **RED** button to display the interactive services information when you see a red "press ●" logo in the top right corner of the screen (e.g. BBC services). This will now display the Red Button menu and available information categories.

To access the pages, use navigation buttons to highlight item required and press the **OK** button to select.

Follow on screen prompts for other functions.

- Press **TXT** or the **EXIT** button to exit.

## Listening to the Radio

You can listen to radio stations through your TV.

- Press the **PGM** button to select the PROGRAMME GUIDE.
- Press the **BLUE** button to select the filter.
- Press the **◀▶** buttons to select RADIO ONLY then press **OK**.
- Press the **▲▼** buttons to select your desired radio station then press **OK** to listen to it.
- The radio stations are from channel position 700, you can also select them using the **P+/P-** buttons or the **NUMBER** buttons.



**Connecting to the Internet (Wired)**

For the fastest and most reliable connection we recommend connecting your TV to the internet using an ethernet cable.

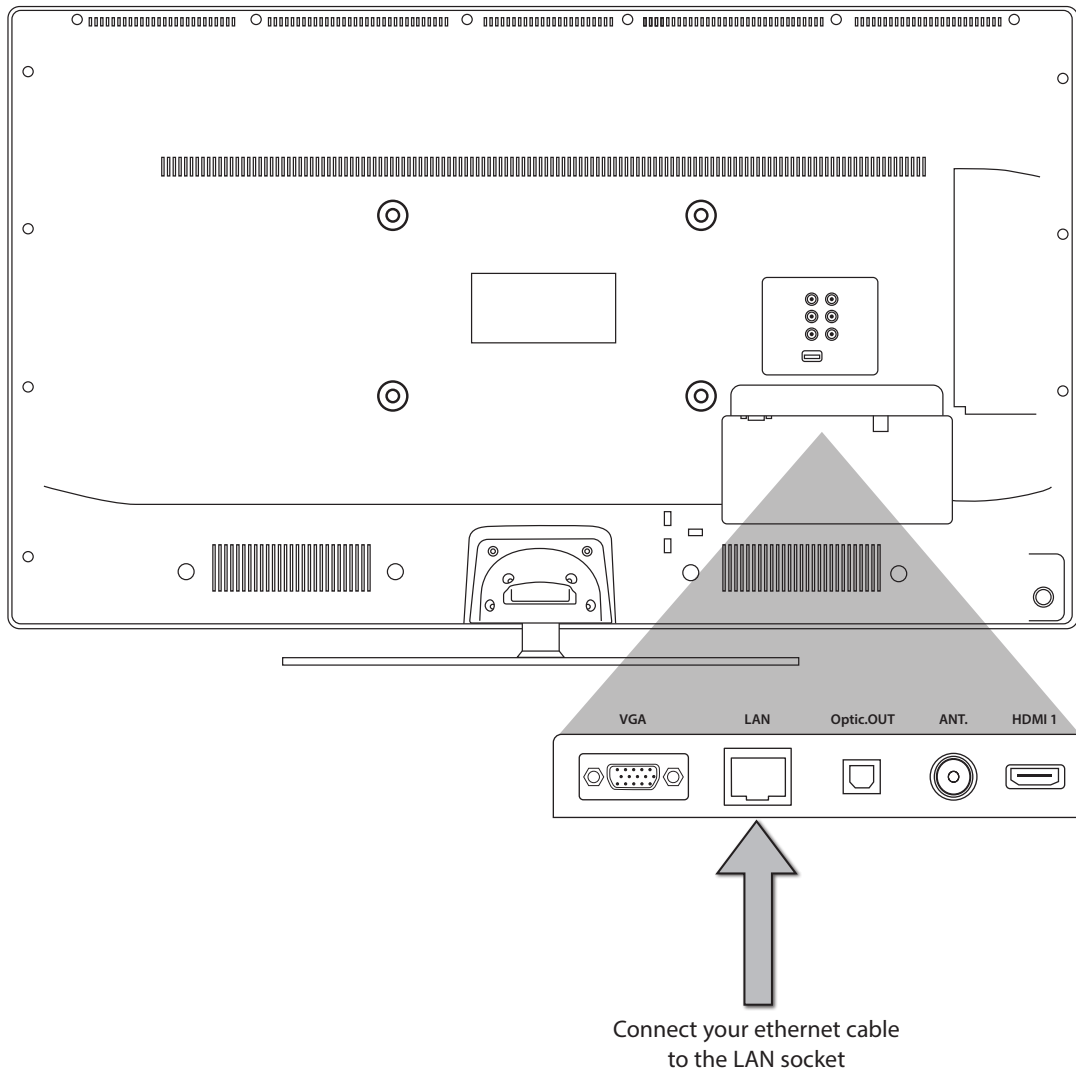

1. Press the **HOME** button then press the **▼** buttons to select **SETTINGS**. Press **▶** to highlight **NETWORK** and press **OK**.



2. Press the **▼** button to highlight **NETWORK TYPE** then press the **◀▶** buttons to select **wired**. The word **connected** will appear to show you are now connected to the internet.

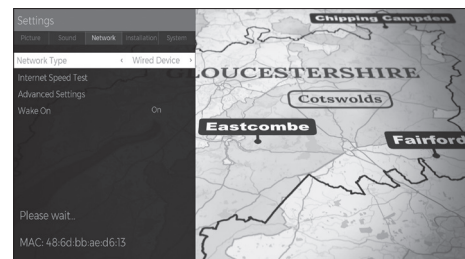

## Connecting to the Internet using wireless

You can connect your TV to your router using the built in wireless connection. This may not always give you the fastest connection speed but may be the most convenient connection method.

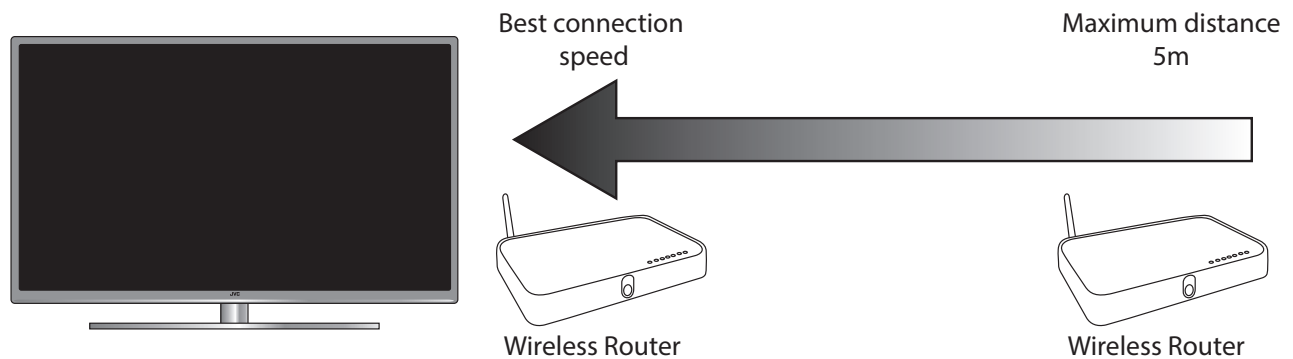

For the best wireless connection its recommended than your router its positioned no more that 5 meters away from your TV and that its in the same room as your TV.

### WIRELESS Connection

- If you want to connect using a wireless connection press the ◀▶ buttons to select WIRELESS DEVICE.

You have two options for connecting to your wireless network. By entering your router PASSWORD or using the WPS button.

#### PASSWORD option

1. Press the ◀▶ buttons to select WIRELESS DEVICE.

2. Press the ▼ button to select SCAN WIRELESS NETWORKS and press **OK**.

Your TV will scan for your wireless network (router). A message saying 'Please wait' will appear while your TV searches for all the wireless networks in your area.

3. Press the ▲▼ buttons to select your wireless network then press **OK**. You now need to enter your password, a keyboard will appear. Press the ◀▶ ▲▼ buttons to select a letter/number/symbol and press **OK** to enter each one. Once you have typed your password highlight **OK** and press **OK**. The network will now show **CONNECTED**.

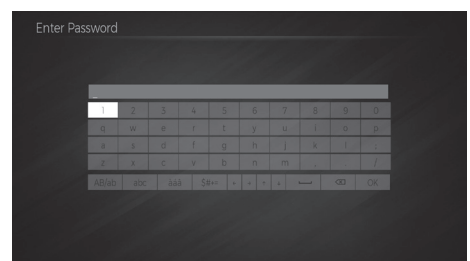
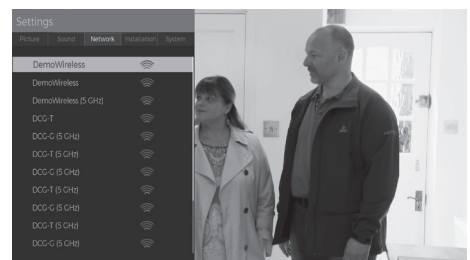

### Wake On

Wake On is a setting that works with your You Tube app on your mobile device. When its switched to on, your TV will automatically switch on when you cast You Tube to your TV. Both devices need to be connected to the same network (router) for this to work.

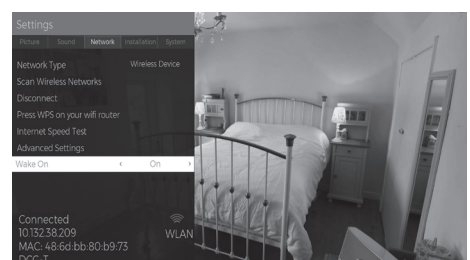

## Connecting to the WPS button

Connecting to your router using the WPS button is ideal if you can't find your password. Pressing the WPS button temporarily disables the security on your router and allows a device to connect without the use of a password.

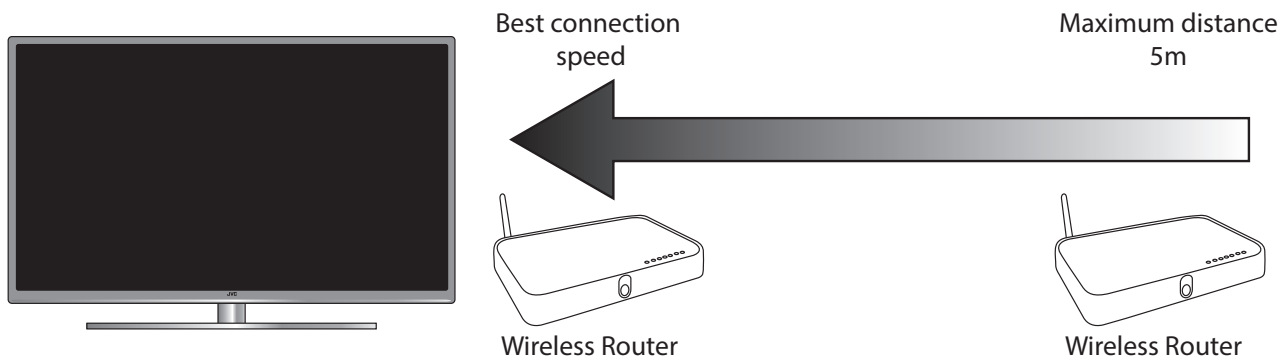

For the best wireless connection its recommended than your router its positioned no more that 5 meters away from your TV and that its in the same room as your TV.

### WIRELESS Connection using the WPS Button

1. Select WIRELESS DEVICE.
2. Press the ▼ button to highlight 'Press WPS on your wifi router' then press **OK**.
3. Now press the WPS button on your router and your TV will connect to your router.

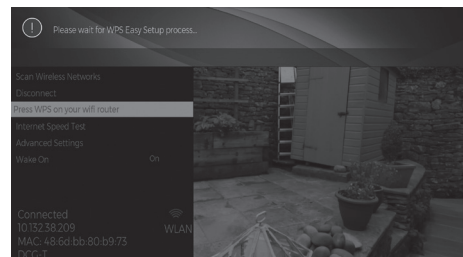

## Using Freeview Play

To use Freeview Play your TV must be connected to the internet. You must also have installed Freeview Play and accepted the Terms and Conditions.

### Catch Up Services

1. Press the **F Play** button on your remote control to access Freeview Play.

The Freeview Page will appear on screen. Here you can access all of the catch up services. The top half of the screen displays the catch up apps and the bottom half displays recommended programmes.

2. Press the ◀▶ to highlight the catch up service that you would like to enter and then press **OK**.
3. Press the ▼ button to highlight recommended programmes.

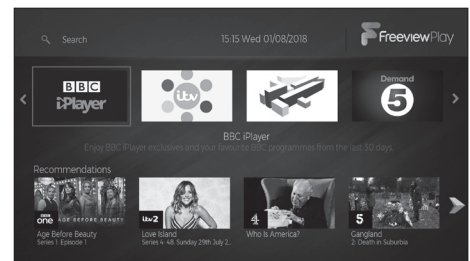
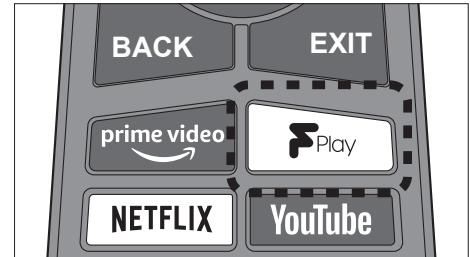

### Recommendations

1. Press the ▼ button to highlight recommended programmes. You will see four recommendations.
2. To see more recommended programmes continually press the ▶ button. You will see the Recommendations page where you can search for recommendations via a genre: **Lifestyle - Movies - Sport -All - Comedy - Drama & Soaps -Entertainment**

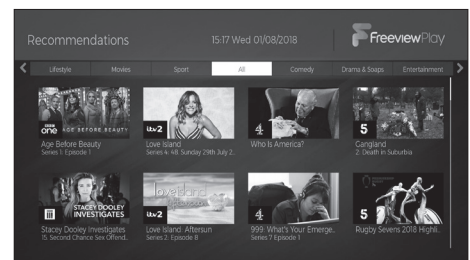
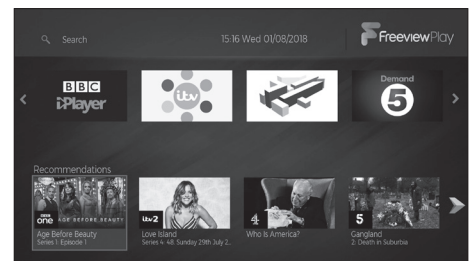



## Freeview Apps Updating

From time to time you might enter the Freeview Play service and notice that an App is missing. **This isn't a fault with your TV**, the App provider may be making improvements or updates to the App. They will take it off line to do this, usually this is only very temporary and the App will return shortly.

### Example: ITV Hub missing



Missing ITV Hub

The ITV Hub is being update, try again later.



The App will return once its been updated.



ITV Hub returns

## Freeview Play 7 day Catch Up through the Programme Guide

You can view TV programmes 7 days back through the Programme Guide. Simply scroll back through the guide. Any programme with an ▶ next to it can be viewed.

1. Press the button on your remote control to access the Programme Guide.
2. Press the ◀▶/ ▲▼ to highlight the program that you wish to view. Remember it has to have a ▶ next to it to be available for playback.
3. Press the **OK** button the view the programme.

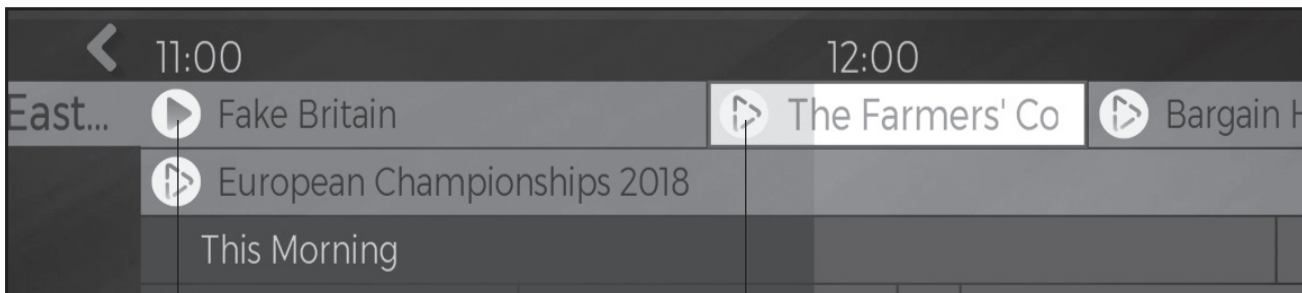

This symbol shows that the programme is available to watch now on catchup.

This symbol shows that the programme is going to be available to watch on catchup when its been shown.



## Using Smart TV

1. Press the  **HOME** button.

The home menu bar has the most popular apps pre-installed. Alternatively you can press the FPLAY, NETFLIX or YOU TUBE button on your remote and it will take you directly into Freeview Play, Netflix or You Tube.

2. Press the  button to highlight your desired app then press **OK** to activate it.



3. As you highlight an app you will see a list of recommended content appear above the menu bar. Press the  button followed by the  and  buttons to highlight your desired content then press the **OK** button to view it.



Your TV will update automatically, so the amount of apps available may vary from time to time. The app content may also be updated.



## Apps

The Apps screen shows all of your Apps that have been downloaded to your TV. Any of these Apps can be added to the Home Menu bar.

1. To launch an app, highlight the app and press **OK**. The select **LAUNCH APP**.

If you decide you don't want to launch the app press the **BACK** button.

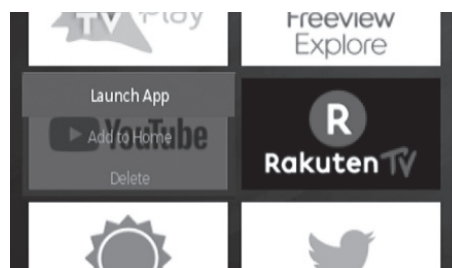
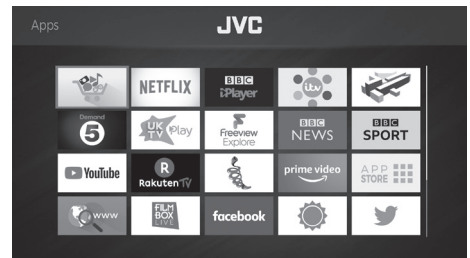

## Deleting an app from Apps

You can delete apps from the Apps screen. They can always be added back in from the MARKET if you change your mind.

1. Highlight the app that you would like to delete and press **OK**.
2. You'll see 3 options **LAUNCH APP**, **ADD TO HOME** and **DELETE**. Press the  button to highlight **DELETE** then press **OK**. The app will now be deleted.



## Market

The Market shows all the Apps that are available on your TV. You can either add them to the Apps section or open the App directly from the Market.

1. Press the **HOME** button. Press the **▲** button to select APPS, then press **▶** to highlight ADD MORE and press **OK**.

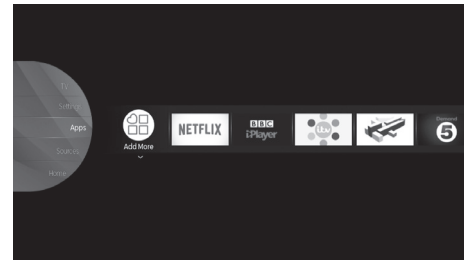

2. The Apps screen will appear. Select the  app.



3. The MARKET screen will appear. This is all the apps that can be downloaded onto your TV. You can launch an app from the Market or move it into the Apps screen, where you can add it to your Home Menu bar.



## Searching for Apps

Rather than scrolling through lists of Apps to find the App you are looking for you can type in a word and a list of apps related to your search will be displayed, e.g. type Weather and all the weather apps will be displayed.

1. Press the **▲** button to select SEARCH at the top of the screen then press **OK**.
2. Press the **◀▶** / **▲▼** and **OK** button to enter your search word then highlight **OK** and press **OK**.
3. A list of available app will appear.

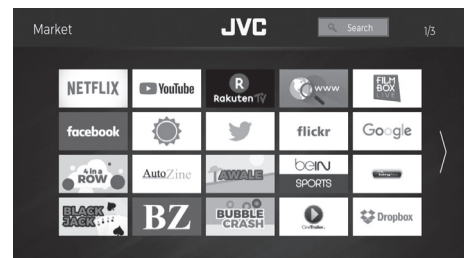

## Using the Internet Browser

You can surf the internet on your TV in just the same way you would on a PC.

1. On the HOME MENU bar select the Internet Browser app. The internet home screen will appear.

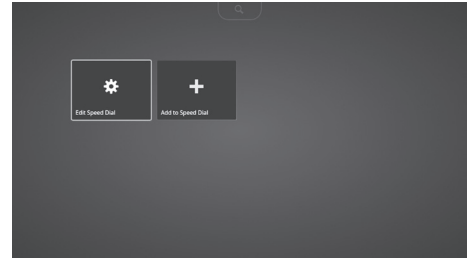
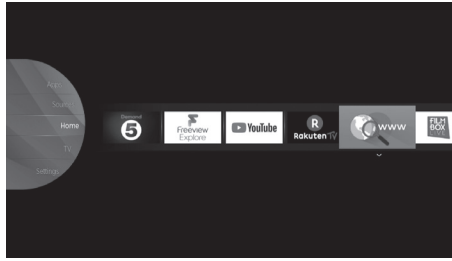

2. Press the ▲ buttons to access the address bar.

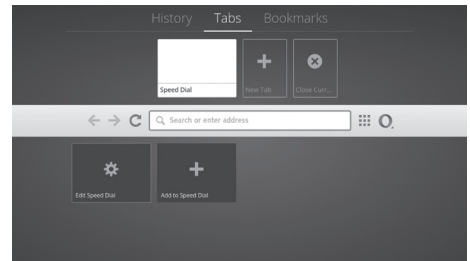

3. With the address bar highlighted press the OK button, a keyboard will now appear on the screen. You can now search the internet. Simply type in what you are looking for and then click on SUBMIT.

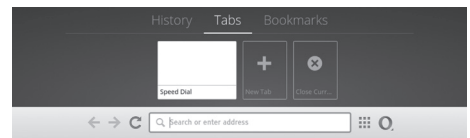

### Adding Bookmarks

You can bookmark web pages to make them quicker and easier to find.

1. Press the ◀▶ ▲▼ buttons to highlight BOOKMARKS then press the ▼ button to highlight ADD TO BOOKMARKS then press OK.
2. Enter the name of your bookmark e.g. BBC, and the address e.g. www.bbc.co.uk. Highlight OK and press OK. Your bookmark will now be saved and added to the top of the page.

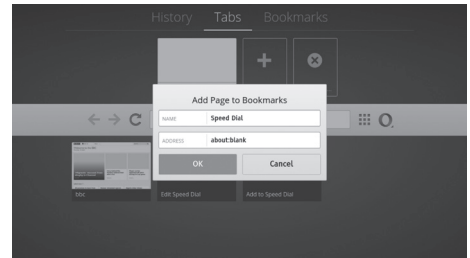

### Adding Tabs

You can add tabs to help you navigate webpages. The tabs will not be saved when you exit the smart hub.

1. Press the ◀▶ ▲▼ buttons to highlight TABS then press the ▼ button to highlight ADD TABS then press OK.
2. Enter the name of your Tab e.g. BBC, and the address e.g. www.bbc.co.uk. Highlight OK and press OK. Your Tab will now appear at the top of the screen.

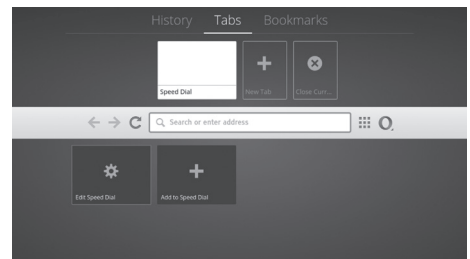

## Adding a Site to Speed Dial

You can add your favourite sites to Speed Dial. They will be saved so you can easily access them without entering the URL each time.

1. Press the ◀▶ ▲▼ buttons to highlight ADD TO SPEED DIAL then press **OK**.
2. Using the keyboard enter a name for your speed dial e.g. BBC.
3. Using the keyboard enter Address for your speed dial e.g. bbc.co.uk.
4. Once you have entered these details your speed dial will appear at the bottom of the screen.
5. To select on of your saved speed dials highlight it and press **OK**. The web browser will open and show the page.

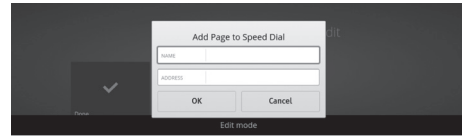

## Editing Speed Dial

You can move, re-name or delete your speed dials.

1. Press the ◀▶ ▲▼ buttons to highlight EDIT SPEED DIAL then press **OK**.
2. A tick and the word done will appear.
3. Press the ◀▶ ▲▼ buttons to select the speed dial you wish to edit. and press **OK**. The edit menu will appear, you can now choose to move, edit or delete the selected speed dial.

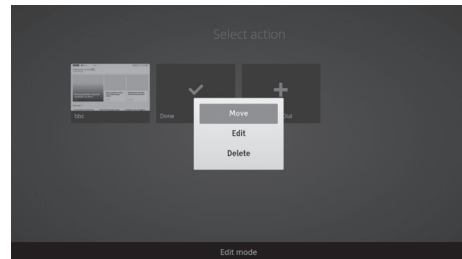

## Opera Menu

The Opera menu can be accessed by selecting the 'O' symbol. This menu give the following options:

- Add to Speed Dial
- Add to bookmarks
- Page Security
- Settings -
  - Zoom
  - Text Size
  - Accessibility Mode (ON/OFF)
  - Always Show Menu Bar (ON/OFF)
  - Clear History
- Help
- Exit Opera TV Browser

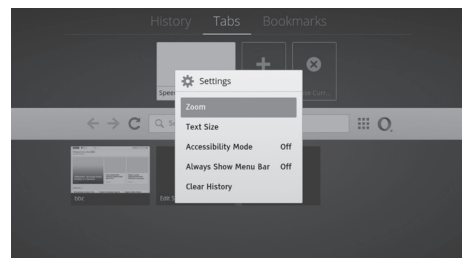
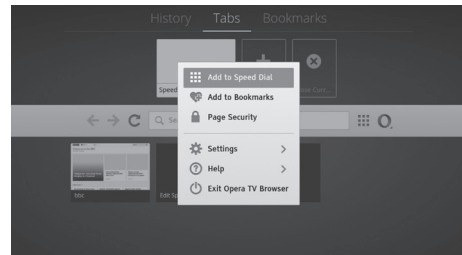

## 6 Using the Smart TV Features

### Casting YouTube to your TV

When viewing YouTube on your mobile device you can cast it to your TV. Your mobile device will detect your TV and switch your TV on if it is in Standby and YouTube will be displayed. **Your TV and mobile device must both be on the same network.**

1. First make sure your TV and Mobile device are on the same network.
2. Select the YouTube app on your mobile device. Press the  at the top of the screen. Your mobile will now connect to your TV. You will see this happening on the screen of your mobile device.

Once your TV has connected, it will switch on if it was in Standby and the YouTube app will be displayed.

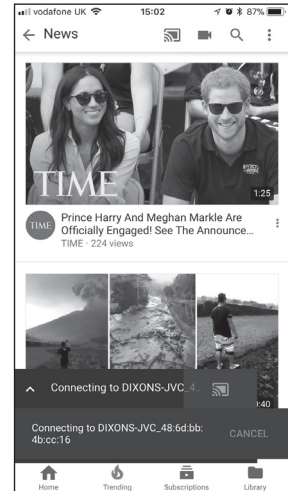

Mobile Device

3. Press play on your mobile device and the video will play on your TV.

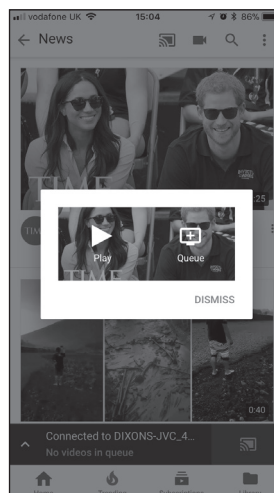

Mobile Device

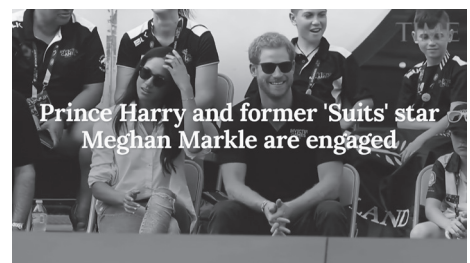

Your TV

## CI (Common Interface) (DTV Mode)

The common interface allows the use of a Common Access Module to enable you to view scrambled (pay-per-view) services. This is for services that may become available in the future. The Common Access Module and viewing card can be obtained from the service provider when available.



Do not repeatedly insert or remove the Common Access Module as this may damage the interface and cause a malfunction.

This feature is not available in all countries.

### To insert the Common Access Module

1. Before you insert the Common Access Module, ensure that the TV is switched off and the viewing card is inserted **in accordance with the Service Provider's instructions**.
2. Insert the Common Access Module into the slot. Flip it to the other side and try again if you feel resistance.
3. Switch the TV on.

### To remove the Common Access Module

1. Before you remove the Common Access Module, ensure that the TV is switched off at the mains.
2. Pull the Common Access Module from the slot.
3. Switch the TV on.

Rear Left Side View of TV



### CI (Common Interface)

Allows the Common Access Module to be inserted and access the content that has been encrypted.

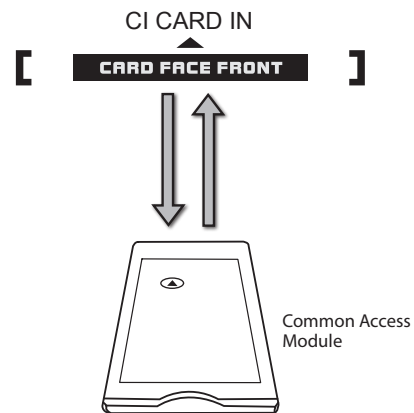

# Privacy Settings

Before you are able to connect to the internet and use the smart features of your TV, you **MUST** make sure that some Privacy Settings are activated. If you haven't activated any of the Privacy Setting when you press the **SMART** button you'll be directed to the Privacy Settings menu or you can select the Privacy settings directly from Settings menu.

To use Smart functions the minimum settings that you will need to activate are **Portal and Applications** and **Internet connection**. For Red Button services you must activate **HbbTV**.

By activating these settings you are allowing the TV Manufacturer to store data to help improve the performance and user experience of your TV.

Each setting has a description, if you press the **P** ^ / v button when the setting is highlighted you will be able to scroll up and down the text to read the description.

The data stored is as follows:

- MAC Address**
- IP Address**
- Country**
- Language**
- Software and Firmware Versions**
- Bootloader Version**
- Source and Brand of TV**

## Select Individual Settings

If you don't want to accept all the setting you can choose to activate settings individually.

1. Press the **HOME** button and then press the **▲** buttons to select the **SETTINGS**. Press the **▶** to highlight **SYSTEM** and press **OK**. The **SYSTEM** menu will be displayed.

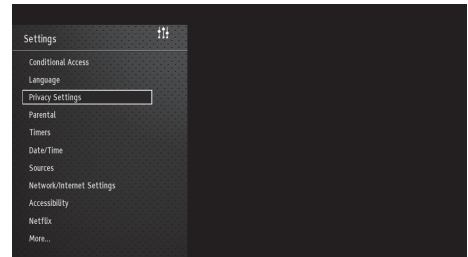

2. First make sure Accept All is deactivated.
3. Press the **▼** button to highlight your desired setting then press **OK** to activate it.
4. Press the **▼** button to highlight **OK** then press **OK**, a list will appear highlighting the settings that you haven't accepted. Select **YES** to continue.

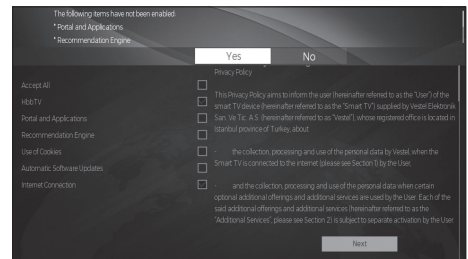
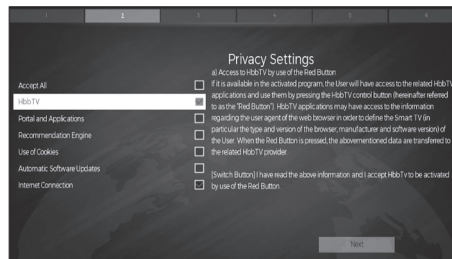

Reminder of setting not selected



If you select your setting and press **EXIT** they won't be saved, you must press **OK** to activate your settings.

## To Accept ALL (recommended)

1. To accept all the setting press the highlight **ACCEPT ALL** and press the **OK** button.
2. The 'Terms of Use' screen will appear. Press **OK** to accept the terms.
3. All of the boxed will now be ticked and **NEXT** will be highlighted, press **OK**.

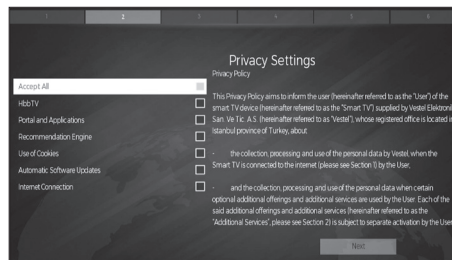

Press **OK** to Accept All

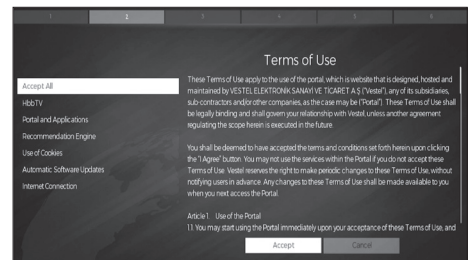

Press **OK** to Accept Terms of Use



To enjoy Freeview Play and Smart functionality your TV must have enabled 'Portal and Applications' and 'Internet Connection' in the Privacy Setting and then connect to the internet.



## Time Settings

The time and date are set automatically. You can manually change the time zone if required.

1. Press the **HOME** button and then press the **▲** buttons to select the **SETTINGS**. Press the **▶** to highlight **SYSTEM** and press **OK**. The **SYSTEM** menu will be displayed.
2. Press the **▲▼** buttons to select **DATE/TIME** and then press the **OK** button.
3. Press the **▲▼** buttons to select **TIME SETTING MODE** and then press the **◀▶** buttons to select **MANUAL**.
4. Press the **▲▼** buttons to select **TIME ZONE** then press the **◀▶** buttons to select your desired time zone.
5. Press the **MENU** button to exit the menu.

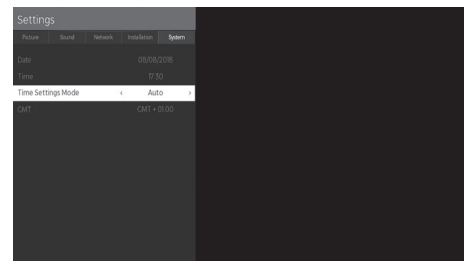
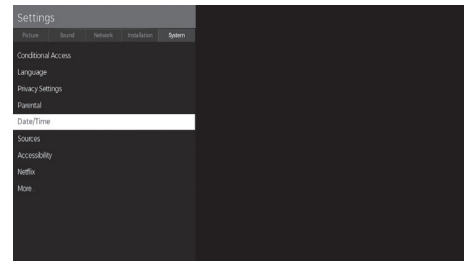

## Accessibility Settings

This setting allows you to switch the Hard of Hearing mode on and off and switch Audio Description on and off.

1. Press the **HOME** button and then press the **▲** buttons to select the **SETTINGS**. Press the **▶** to highlight **SYSTEM** and press **OK**. The **SYSTEM** menu will be displayed.
2. Press the **▲▼** buttons to select **ACCESSIBILITY SETTINGS** and then press the **OK** button.

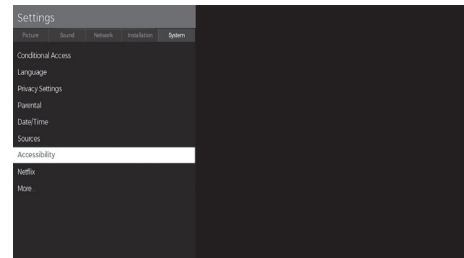

### Hard of Hearing

Hard of Hearing will enhance the dialogue to make it easier to hear. Select ON or OFF.

### Audio Description

Audio description describes the action when people aren't speaking.

- Select **AUDIO DESCRIPTION** then press the **OK** button.
- If any available languages are available then press the **◀▶** to select your desired language.
- Press the **◀▶** to select your preferred language.
- Press the **◀▶** to set your desired volume of the audio description.

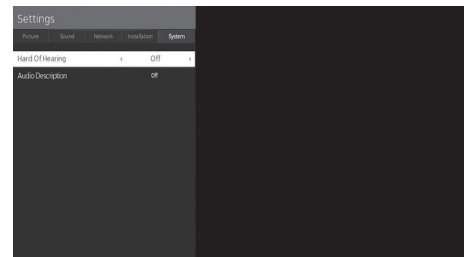

3. Press the **MENU** button to exit the menu.

## More Settings

The More Settings menu has more advanced setting that you can adjust, these are not everyday setting.

1. Press the **HOME** button and then press the **▲** buttons to select the **SETTINGS**. Press the **▶** to highlight **SYSTEM** and press **OK**. The **SYSTEM** menu will be displayed.
2. Press the **▲▼** buttons to select **MORE** and then press the **OK** button.

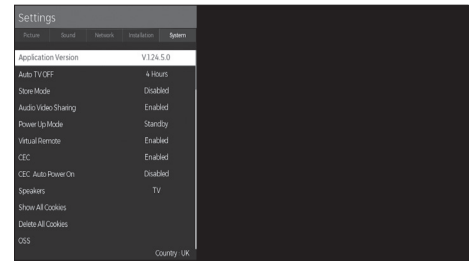
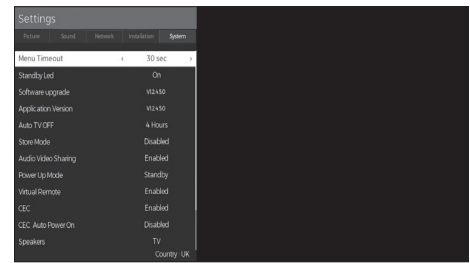

<b>Menu Timeout</b>	You can select a time that your TV menus will be displayed. If you select OFF the menu will remain on the screen until you press a button to remove it. OFF - 15 Sec - 30 Sec - 60 Sec.
<b>Standby Led</b>	You can switch the standby LED off using this setting.
<b>Software upgrade</b>	<ul style="list-style-type: none"> <li>• Select <b>SOFTWARE UPGRADE</b> then press <b>OK</b>. The Upgrade Options menu will appear.</li> <li>• Press the <b>◀▶</b> to enable or disable <b>AUTOMATIC SCANNING</b>.</li> <li>• To manually scan for an upgrade select <b>SCAN FOR UPGRADE</b> then press <b>OK</b>.</li> </ul>
<b>Auto TV OFF</b>	Select a time that you would like your TV to switch off if no buttons are pressed for a certain amount of time. OFF - 1 HOUR - 2 HOURS - 3 HOURS - 4 HOURS - 5 HOURS - 6 HOURS - 7 HOURS - 8 HOURS
<b>Store Mode</b>	Press the <b>◀▶</b> to select enable or disable store mode. Store mode will brighten the display.
<b>Audio Video Sharing</b>	Press the <b>◀▶</b> to select enable or disable audio video sharing.
<b>Power Up Mode</b>	Press the <b>◀▶</b> to select <b>STANDBY</b> or <b>LAST STATE</b> . If you choose <b>LAST STATE</b> , and switch your TV off and back on again at the mains it will switch on at its last state. Its best to leave it as <b>STANDBY</b> , otherwise your TV may switch on after a power cut.
<b>Virtual Remote</b>	Press the <b>◀▶</b> to select enable or disable virtual remote.
<b>CEC</b>	Press the <b>◀▶</b> to select enable or disable virtual remote.
<b>CEC Auto Power On</b>	Press the <b>◀▶</b> to select enable or disable virtual remote.
<b>Speaker</b>	Press the <b>◀▶</b> to select <b>TV</b> or <b>Amplifier</b> . CEC has to be set to <b>Enable</b> to access this setting.
<b>Show All Cookies</b>	Press <b>OK</b> to see a list a list of all the cookies saved on your TV.
<b>Delete All Cookies</b>	Press <b>OK</b> then select <b>YES</b> to delete all the cookies stored on your TV.
<b>OSS</b>	Press <b>OK</b> to view the licencing information of your TV.



When in Smart or Media modes the CEC function will not function. For CEC to function properly your TV must be in TV mode.

## HDMI ARC (Audio Return Channel)

The ARC (Audio Return Channel) function allows you to send audio from your ARC-compliant TV to ARC-compliant audio devices (e.g. soundbar) through a single HDMI connection.

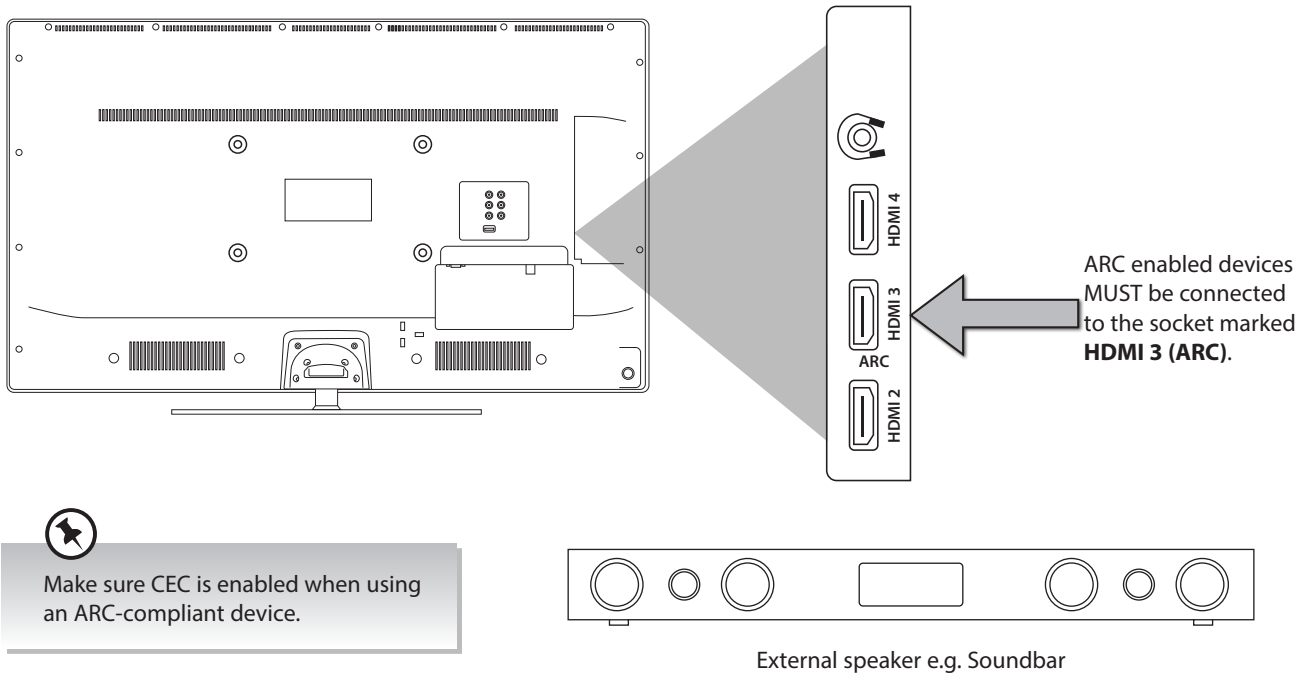

### HDMI-ARC Connection

To enjoy the ARC function, please ensure your ARC-compliant audio devices are connected by an HDMI cable that support the ARC function to the HDMI 3(ARC) port of your ARC-compliant TV. When correctly set up, you can use your TV remote control to adjust the volume output (VOL +/- and MUTE) of the connected audio device.

1. Make sure your TV and ARC-compliant device are disconnected from the main and switched off.
2. Connect your ARC-compliant device to your TV making sure you use the HDMI3 (ARC) socket on the back of the TV. The plug in and switch on at the mains.
3. Press the **HOME** button and then press the **▲** buttons to select the **SETTINGS**. Press the **▶** to highlight **SYSTEM** and press **OK**. The **SYSTEM** menu will be displayed..
4. Press the **▲▼** buttons to select **MORE** then press **OK**.

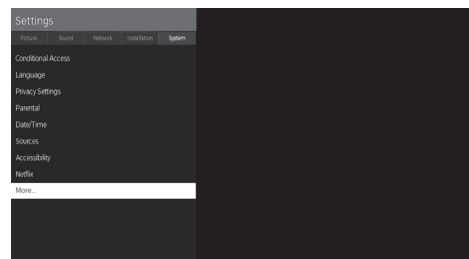
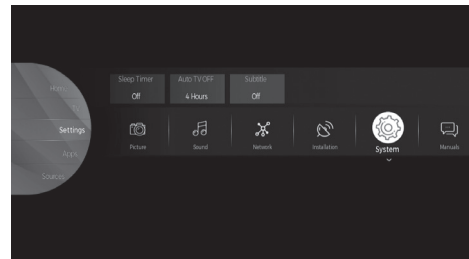

5. Press the **▲▼** buttons to select **SPEAKERS** then press the **◀▶** buttons to select **AMPLIFIER**. It may take up to 15 seconds before you hear sound from your external speaker, this is normal.

You will now be able to use your TV remote control to adjust the volume of your external speaker and the speaker will also switch into on/standby when you switch your TV on and off.

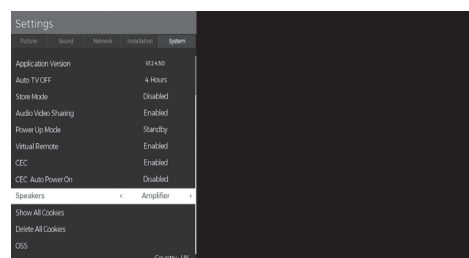

## Language Settings

Allows you to select your desired language settings for your TV.

1. Press the **HOME** button and then press the **▲** buttons to select the **SETTINGS**. Press the **▶** to highlight **SYSTEM** and press **OK**. The **SYSTEM** menu will be displayed.
2. Press the **▲▼** buttons to select **LANGUAGE** and then press the **OK** button.

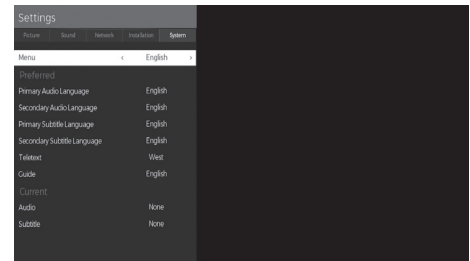

<b>Menu</b>	Press the <b>◀▶</b> buttons to select your desired menu language.
<b>Preferred</b>	
<b>Audio</b>	Press the <b>◀▶</b> buttons to select your preferred audio language.
<b>Subtitle</b>	Press the <b>◀▶</b> buttons to select your preferred subtitle language.
<b>Teletext</b>	Press the <b>◀▶</b> buttons to select your preferred teletext language.
<b>Guide</b>	Press the <b>◀▶</b> buttons to select your preferred guide language.
<b>Current</b>	
<b>Audio</b>	Shows the current audio language, this may not be able to be changed.
<b>Subtitle</b>	Shows the current subtitle language. Press the <b>◀▶</b> buttons to select a different subtitle language.

## Sources

In the **SOURCE SETTING** menu you can decide to switch each input source on or off, by selecting **ENABLED** or **DISABLED**. When viewing **HDMI** sources you also have the option for **REGULAR** and **ENHANCED** as well as **ENABLED** and **DISABLED**. When viewing **HDR** content through **HDMI** select **ENHANCED**.

1. Press the **HOME** button and then press the **▲** buttons to select the **SETTINGS**. Press the **▶** to highlight **SOURCE SETTINGS** and press **OK**. The **SETTINGS** menu will be displayed.
2. Press the **▲▼** buttons to select **SOURCES** and then press the **OK** button.

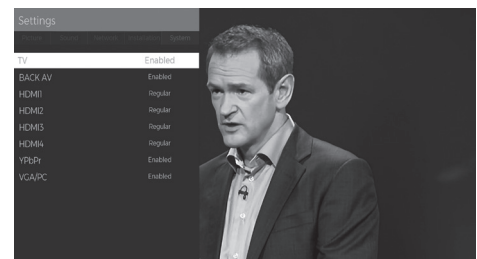

### Editing the Source

1. Press the **▲▼** buttons to select a source then press the **▶** button the **OPTIONS** menu will appear.
2. Press the **▲▼** buttons to select your desired option. You can select **REGULAR**, **ENHANCED**, **DISABLED** or **EDIT NAME**. Edit name allows you to enter a name for your source e.g **DVD**.



- For **HDR** viewing on **HDMI** select **ENHANCED**.

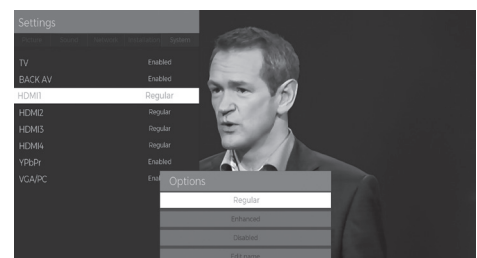

## Resetting your TV

Restores all settings to the factory defaults and will delete all channels you currently have stored.

1. Press the **HOME** button and then press the **▲** buttons to select the **SETTINGS**. Press the **▶** to highlight **INSTALLATION** and press **OK**. The **INSTALLATION** menu will be displayed.
2. Press the **▲▼** buttons to select **FIRST TIME INSTALLATION** and then press the **OK** button.
3. Press the **▲▼** buttons to select **YES** the press **OK**. The screen will turn black and then in a few seconds you will see the **FIRST TIME INSTALLATION MENU**.



All channel and user settings will be lost and the TV will revert to "First Time Installation".

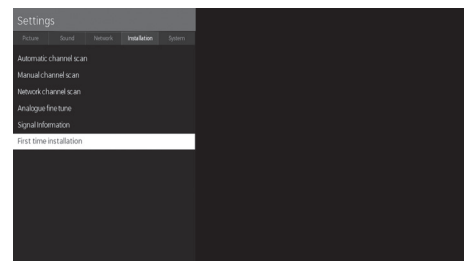
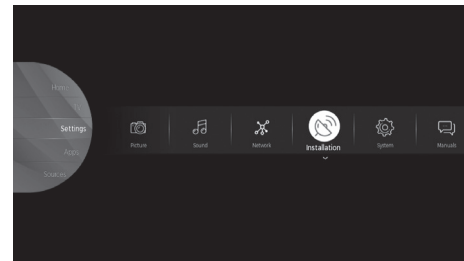

## Parental Settings

To access the **PARENTAL SETTINGS** menu options, you must enter the password. Enter the default password **"0000"** for first time use. To change the password, select SET PIN.

1. Press the **HOME** button and then press the **▲** buttons to select the **SETTINGS**. Press the **▶** to highlight **SYSTEM** and press **OK**. The **SYSTEM** menu will be displayed.

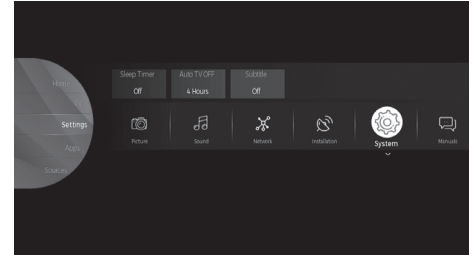

2. Press the **▲▼** buttons to select **PARENTAL** and then press the **OK** button.

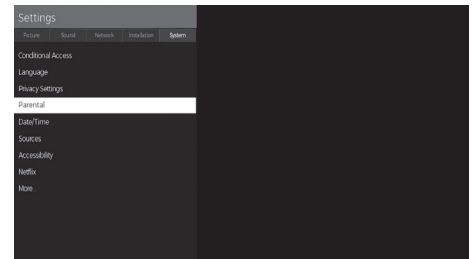

3. Press the **NUMBER** buttons to enter your PIN number. The **PARENTAL SETTINGS** menu will appear on screen.

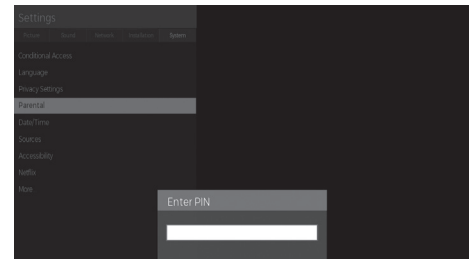

<p><b>Menu Lock</b></p>	<p>You can lock all of the menus or just the installation menus. Press the <b>◀▶</b> buttons to select <b>ALL MENUS - INSTALLATION MENUS - OFF</b>. If you choose to lock the menu you will have to enter your PIN number to enter the selected menu.</p>
<p><b>Child Lock</b></p>	<p>The child lock will prevent the buttons working on your TV, to stop children from accidentally changing any of the settings. Press the <b>◀▶</b> buttons to set the child lock to <b>ON</b> or <b>OFF</b>.</p>
<p><b>Set PIN</b></p>	<ul style="list-style-type: none"> <li>• Press the <b>▲▼</b> buttons to select <b>SET PIN</b>.</li> <li>• Press <b>OK</b>.</li> <li>• Press the <b>NUMBER</b> buttons to enter and <b>NEW PIN</b></li> <li>• Press the <b>NUMBER</b> buttons to <b>CONFIRM</b> the new pin. The words 'PIN CHANGED' will briefly appear on the screen.</li> </ul> <p>Don't forget to make a note of your new PIN number.</p>





The default password is **"0000"**.  
If you change the password, be sure to remember the new password!

## Connecting a USB Storage Device



You must use a USB storage device with a minimum of 2GB of storage space.

1. Switch off the TV before connecting any USB storage device.
2. Connect your USB storage device to the USB port of your TV. If your USB device is powered by the main, plug the connected devices into the mains socket and switch on.
3. Press the  button on the remote control to turn on your TV.
4. Press the  button on the remote control to enter MEDIA BROWSER mode.

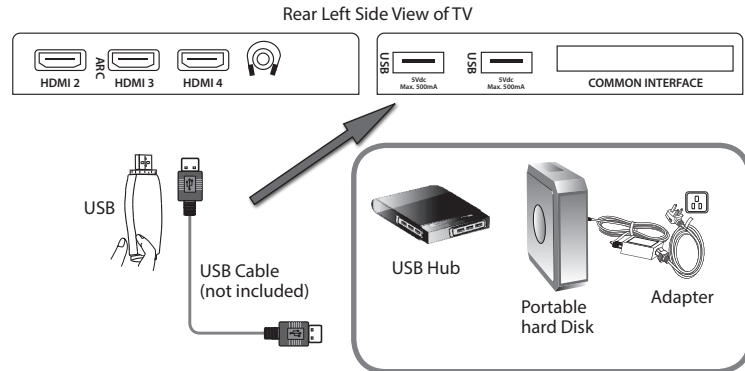

- Some versions of portable hard disk may require more power than the TV USB socket can provide. To ensure correct operation please use the power adapter for that device.
- If a USB hub is used, make sure its mains adapter is connected to the mains supply as the total current consumption may exceed 500mA.
- The file system only supports FAT32 format.
- If you want to store the video streaming of a DTV programme, the transfer rate of the USB storage device must not be less than 5MB/s, otherwise the picture and sound of the programme will be affected and a warning statement will be shown on the screen. If this happens, please upgrade your USB storage device.
- The TV screen will be blank temporarily as it will take time to start up and stabilise the connected hard disk. This is normal and the starting time may vary depending on the brand and the memory size of the connected hard disk.
- Disconnect the USB storage device if it is not in use.

## Media Browser

1. When you connect a USB device to your TV the MEDIA BROWSER will automatically open. If your USB device was already connected then press the **HOME** button and then press the **▲** buttons to select the SOURCES. Press the **▶** to highlight USB1 and press **OK**. The MEDIA BROWSER will open.

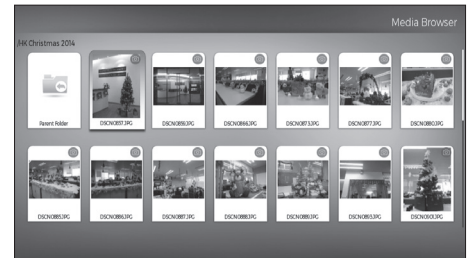

2. Press the **◀▶▲▼** buttons to select a **file** and then press the **OK** button to view/listen to it.



## Media Browser Settings

1. When viewing a file press the **▲** button and the navigation bar will appear at the bottom of the screen.
2. Press the **▶** to scroll across to the cog symbol on the right hand side and press **OK**.
3. Press the **▼** button to highlight MEDIA BROWSER SETTINGS and press **OK**.
4. You'll now see all the settings for the media type that you are viewing.

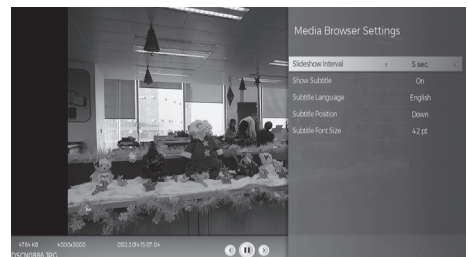
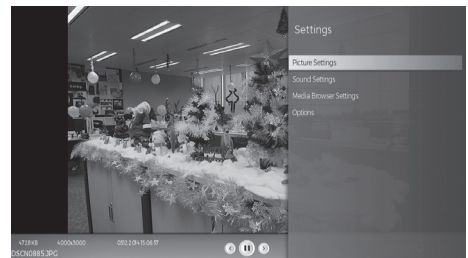

- Supported file Video formats: MPEG1 & 2, VOB, and MKV.
- Supported file Picture formats: JPEG and BMP.
- Supported file Music formats: MP3 and WMA /ASF.



## Maintenance

---

Careful and regular cleaning can prolong the life of your TV.



Be sure to press the  button on the remote control and disconnect the mains cable from the mains socket before any cleaning.

1. Use a soft dry cloth to wipe away the dust from the screen and surfaces.
2. If the surfaces are extremely dirty, clean the TV with a damp cloth.
3. Ensure there is no excess water on the screen. Allow any water or dampness to evaporate before switching the TV on.



Never use alcohol, benzine, paint-thinner, cleaning fluid or other chemicals. Do not use compressed air to remove dust.

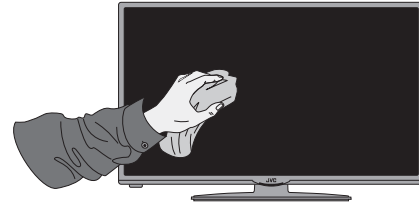

## Hints and Tips

The following table contains various hints and tips to get the best performance from your TV. If you require additional assistance please call our Call Centre on (UK) **0344 561 1234** or (Ireland) **1 890 818575**. Our Customer Contact Centre is open 24/7.

The TV does not operate properly.	
<b>The TV does not respond when pressing any buttons</b>	<ul style="list-style-type: none"> <li>The TV may freeze up during use. Switch the TV off at the mains for a few minutes. Switch on again and try to operate it again as usual.</li> </ul>
<b>TV cannot be switched on</b>	<ul style="list-style-type: none"> <li>Check that the TV is connected to the mains supply and switched on.</li> <li>Make sure all connected AV devices are switched off before switching on your TV.</li> </ul>
<b>The remote control does not work</b>	<ul style="list-style-type: none"> <li>Check to see if there are any objects between the TV and the remote control causing an obstruction. Ensure that you are pointing the remote control directly at the TV.</li> <li>Ensure that the batteries are installed with the correct polarity (+ to +, - to -).</li> <li>Install new batteries.</li> </ul>
<b>Power is suddenly turned off</b>	<ul style="list-style-type: none"> <li>Check the TV has power to it. The mains supply maybe interrupted.</li> <li>Check if the sleep timer is set.</li> <li>Check whether the Auto Standby is activated.</li> </ul>
The video function does not work.	
<b>No Picture &amp; No Sound</b>	<ul style="list-style-type: none"> <li>Check whether the TV is switched on.</li> <li>Try another channel. The problem may be caused by the broadcaster.</li> </ul>
<b>Picture appears slowly after switching on</b>	<ul style="list-style-type: none"> <li>This is normal, the image is muted during the TV startup process. Please contact your service centre, if the picture has not appeared after five minutes.</li> </ul>
<b>No or poor colour or poor picture</b>	<ul style="list-style-type: none"> <li>Adjust the settings in the <b>PICTURE</b> menu.</li> <li>Try another channel. The problem may be caused by the broadcaster.</li> <li>Check if the video cables are connected properly.</li> <li>Check that you are watching the correct resolution i.e. SD, HD or 4K.</li> </ul>
<b>Horizontal / Vertical bar or picture shaking</b>	<ul style="list-style-type: none"> <li>Check for local interference such as an electrical appliance or power tool.</li> </ul>
<b>Poor reception on some channels</b>	<ul style="list-style-type: none"> <li>Station or cable channel may be experiencing problems, tune to another station.</li> <li>Station signal is weak, reposition the aerial for better reception.</li> <li>Check for sources of possible interference.</li> </ul>
<b>Lines or streaks in pictures</b>	<ul style="list-style-type: none"> <li>Check aerial (Change the position of the aerial.)</li> </ul>
<b>No pictures when connecting HDMI</b>	<ul style="list-style-type: none"> <li>Check if the input source is <b>HDMI 1, 2, 3 or 4</b>.</li> </ul>
<b>Picture appears in wrong ratio</b>	<ul style="list-style-type: none"> <li>Adjust the <b>Aspect Ratio</b>. Press the  (<b>ASPECT</b>) button on the remote control.</li> </ul>
<b>What is HDR / Dolby Vision™?</b>	<ul style="list-style-type: none"> <li>This TV has Dolby Vision to provide <b>High Dynamic Range (HDR)</b> and is compatible with HDR 10. Using this feature the TV can reproduce a greater dynamic range of luminosity by capturing and combining several different exposures. HDR promises better picture quality thanks to brighter, more realistic highlights, more realistic colour and other improvements. It delivers the look that film makers intended to achieve, showing hidden areas of dark shadows and sunlight in full clarity colour and detail.</li> <li>Dolby Vision present stunning, true-to-life images with amazing amounts of detail that other post-processing technologies in the TV aren't able to produce. Dolby Vision is supported via native and portal applications, HDMI and USB inputs. In the MENU-PICTURE-MODE menu two picture modes will be available if Dolby vision content is detected. <b>Dolby Vision Bright</b> and <b>Dolby Vision Dark</b>. As the names indicate you may experience the content as the creator intended, with bright and dark options, considering the ambient luminance.</li> </ul>
<b>HDR isn't working on HDMI sources</b>	<ul style="list-style-type: none"> <li>When viewing HDR content via a HDMI source you must select ENHANCED in the SOURCE SETTINGS menu. MENU - SETTINGS - SOURCES</li> </ul>

The audio function does not work.	
<b>Picture OK but no sound</b>	<ul style="list-style-type: none"> <li>• Press the <b>VOL + / -</b> buttons.</li> <li>• Sound muted? Press the <b>MUTE</b> button.</li> <li>• Try another channel. The problem may be caused by the broadcaster.</li> </ul>
<b>No output from one of the speakers</b>	<ul style="list-style-type: none"> <li>• Adjust the <b>Balance</b> settings in the <b>SOUND</b> menu.</li> </ul>
<b>Unusual sound from inside the TV</b>	<ul style="list-style-type: none"> <li>• A change in ambient humidity or temperature may result in an unusual noise when the TV is switched on or off and does not indicate a fault with the TV.</li> </ul>
<b>No sound when connecting HDMI</b>	<ul style="list-style-type: none"> <li>• Check if the input source is <b>HDMI1, 2, 3 or 4</b>.</li> </ul>
<b>Audio noise</b>	<ul style="list-style-type: none"> <li>• Keep the RF coaxial cable away from other connected cables.</li> </ul>
<b>Audio level changes at night and early morning</b>	<ul style="list-style-type: none"> <li>• AVL is set to AUTO, the volume will automatically reduce between 10pm and 7am so not to disturb others at night. To stop this from happening change AVL to NORMAL.</li> </ul>
Password	
<b>Lost password</b>	<ul style="list-style-type: none"> <li>• Select the <b>Set Password</b> setting in the <b>LOCK</b> menu, then enter the following master password "4725". The master password clears your previous password and allows you to enter a new password.</li> </ul>
There is a problem in PC mode.	
<b>The signal is out of range (Invalid format)</b>	<ul style="list-style-type: none"> <li>• Adjust the resolution, horizontal frequency, or vertical frequency.</li> </ul>
<b>Vertical bar or stripe on background &amp; horizontal noise &amp; incorrect position</b>	<ul style="list-style-type: none"> <li>• Use Auto configure or adjust clock, phase, or H/V position.</li> </ul>
<b>Screen colour is unstable or shows a single colour</b>	<ul style="list-style-type: none"> <li>• Check the signal cable.</li> <li>• Reinstall the PC video card.</li> </ul>
Smart or Freeview Play TV isn't working	
<b>Can't access Smart TV or Freeview Play</b>	<ul style="list-style-type: none"> <li>• Check you are connected to your router and that the router is switch on and working.</li> <li>• Your router may be to far away from your TV, move your router closer to your TV.</li> <li>• Try connecting your TV to your router using an ethernet cable.</li> </ul>
<b>Smart TV is very slow to activate</b>	<ul style="list-style-type: none"> <li>• Your internet speed may be very slow, check your speed with your internet provider.</li> </ul>
<b>Some of the Apps have disappeared or changed from Smart TV</b>	<ul style="list-style-type: none"> <li>• The Apps on your TV may have been updated or even removed this can happen at any time. Its normal and not a fault of your TV.</li> </ul>
FAQs (Frequently Asked Questions)	
<b>Why have I lost some / all of my channels?</b>	<ul style="list-style-type: none"> <li>• It happens sometimes if you have a weak signal. Usually it just means you'll need to re-tune your TV. Don't worry, it is easy to do. And once you've done it, you should get all the Freeview channels available to you. If problems persist you may need to get your aerial checked. Talk to your retailer or contact your local aerial installer.</li> </ul>
<b>Why do I get 'blocking' on my digital picture?</b>	<ul style="list-style-type: none"> <li>• In most cases, blocking is caused by a reception problem – either the signal is too weak or there is some kind of interference. Talk to your retailer or contact your local aerial installer.</li> <li>• Blocking can also be caused by a digital signal that is too strong. If you are still experiencing blocking and the signal is strong, consult your local aerial installer for advice.</li> </ul>
<b>Can I watch Freeview using a portable set-top aerial?</b>	<ul style="list-style-type: none"> <li>• Some, but only a few, homes may be able to use a set top aerial. However, for a much better reception, we strongly recommend that you use a rooftop aerial.</li> <li>• If you do not have access to a rooftop aerial – for example, if you rent a flat and the aerial is the responsibility of your landlord, or if you're using a second TV in the bedroom and don't want the hassle and expense of using extension cables, a set top aerial may be your only option.</li> </ul>
<b>What type of aerial do I need?</b>	<ul style="list-style-type: none"> <li>• If you are installing a new aerial, we recommend a wideband rooftop aerial rather than a loft aerial. Loft aerials generally receive a weaker digital signal and are more likely to get interference from other electrical devices at home. We suggest you have an aerial survey done before getting an aerial upgrade.</li> <li>• Talk to your retailer or contact your local aerial installer.</li> </ul>

## Remote Control Codes

---

### Sky Codes

The code for controlling your TV using a Sky Remote Control is **0065**. For instruction on how to use the code see your Sky instruction manual.

### Virgin Media Codes (TiVo box)

The codes for controlling your TV using a Virgin Media Remote Control are **0044, 0049, 0101, 0107, 0125, 0152, 0166, 0379, 0654**. For instruction on how to use the code see your Virgin Media instruction manual.

### BT Vision

The codes for controlling your TV using a BT Vision Remote Control are **0000, 0019, 0725, 0669, 0016, 0152, 0184, 0197, 0198, 0225, 0244, 0324, 0325, 0339, 0319**. For instruction on how to use the code see your BT Vision instruction manual.

## Declaration of Conformity

---



Hereby, DSG Retail Ltd., declares that this TV (LT-55C898) is in compliance with Directive 2014/53/EU. The full text of the EU declaration of conformity is available at the following internet address: <https://www.teamknowhow.com>  
Click on **SEARCH** and enter the model number.

## Product Fiche and Specifications

<b>Brand</b>	<b>JVC</b>
<b>Model</b>	<b>LT-55C898</b>
<b>Energy Efficiency Class</b>	A++
<b>Screen Size (measured diagonally)</b>	55" - 140cm
<b>Power Consumption (In HOME mode)</b>	60W
<b>Average Annual Energy Consumption **</b>	87 kWh / annum
<b>Standby Power Consumption</b>	0.5W
<b>Display Resolution</b>	3840 pixels (horizontal) x 2160 pixels (vertical)
<b>Panel System</b>	55 inch Edge lit LED Panel
<b>Television System</b>	PAL I / BG / DK DVB-T2 (VIDEO: MPEG-4 MP@ML, SOUND: AAC, MPEG-1 LAYER 1/2, MPEG-2 LAYER 2)
<b>Brightness</b>	350 cd/m <sup>2</sup>
<b>Contrast Ratio</b>	6000 : 1
<b>Power Source</b>	220-240V ~50Hz
<b>Operating Temperature</b>	0°C – 40°C
<b>Operating Humidity</b>	80% (max)
<b>Mercury Content (mg)</b>	X
<b>Presence of Lead</b>	√*
<b>Reference Period</b>	2010/1062 - 2017
<b>Speaker Power</b>	2 x 10W
<b>Dimension( W x H x D) with base</b>	1238(W) x 763(H) x 245(D)
<b>Weight (Net)</b>	18.35kg
<b>Inputs / Output</b>	
<b>AV</b>	1
<b>HDMI</b>	4 (HDMI 3 with ARC)
<b>PC-RGB (VGA)</b>	1
<b>BACK AV (L &amp; R)</b>	1
<b>YPbPr</b>	1
<b>Common Interface</b>	1
<b>USB</b>	3 x USB 2.0 (Side and Rear)
<b>ANT. (Aerial socket)</b>	1
<b>SPDIF (Optical)</b>	1
<b>Headphone</b>	1
<b>Ethernet (RJ-45)</b>	1
<b>Built in wireless network</b>	Yes

<b>Wireless LAN Transmitter</b>	
<b>Frequency Ranges</b>	<b>Max Output Power</b>
2400 - 2483,5 MHz (CH1-CH13)	< 100 mW
5150 - 5250 MHz (CH36 - CH48)	< 200 mW
5250 - 5350 MHz (CH52 - CH64)	< 200 mW
5470 - 5725 MHz (CH100 - CH140)	< 200 mW

Features and specifications are subject to change without prior notice.

\*This television contains lead in certain parts or components where no technology alternatives exist in accordance with existing exemption clauses under the RoHS Directive.

\*\*Energy consumption 87 kWh per year, based on the power consumption of the television operating 4 hours per day for 365 days. The actual energy consumption will depend on how the television is used.

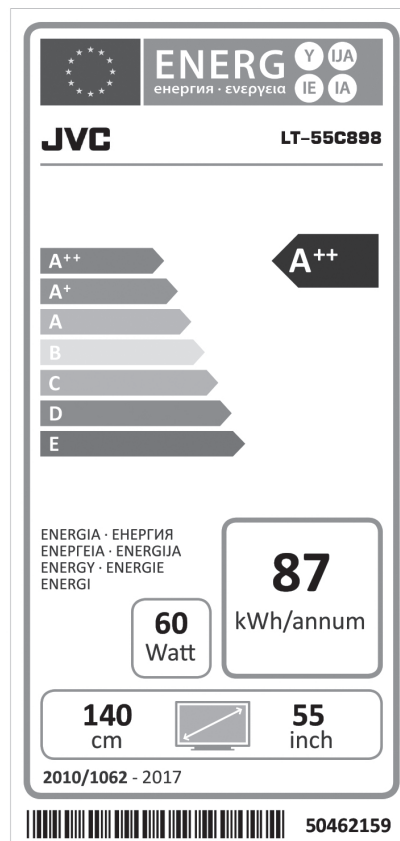

## License Information used with JVC Televisions

The software pre-installed in the JVC Digital Televisions consists of multiple, independent software components. Each software component is copyrighted by JVC or a third party. The JVC Digital Televisions uses software components that are distributed as freeware under a third-party end-user license agreement or copyright notice (hereinafter referred to as a "EULA"). Some EULAs require that the source code of the applicable component be disclosed as the condition for distributing the software component in executable format. The JVC warranty provided in respect of the Digital TV is the only warranty provided and no additional warranties are provided in respect of the software components subject to EULAs. Some of the software components distributed under EULAs are made available for use by the user on the premise that they are not copyrighted or warranted by JVC or any third party. These software components are licensed to the user free of charge and therefore not covered by any warranty within the scope of the applicable laws. These software components are provided in "as is" condition without any warranty, whether express or implied. "Warranty" here includes, but not limited to, an implied warranty for marketability or fitness for specific uses. All risks associated with the quality or performance of these software components are assumed by the user. JVC shall not be liable whatsoever for any cost of repair or correction or other incidental expense incurred in connection with a defect found in any of these software components. Unless specified under the applicable laws or in a written agreement, a party who changes or redistributes the software with consent from the copyright holders or based on the aforementioned licenses shall not be held liable whatsoever for any loss arising from the use of or inability to use such software components. The same applies even when the copyright holders or relevant third parties have been informed of the possibility of such loss. "Loss" here includes normal, special, incidental and indirect loss (including, but not limited to, the loss of data or its accuracy; loss incurred by the user or any third party; and interface incompatibility with other software).

Please read each EULA for details on the use conditions and items that must be observed regarding these software components. For details of software components covered by "GPL", please visit the following website:

<https://www.teamknowhow.com>

Click on **SEARCH** and enter the model number.



For general information about this appliance and handy hints and tips, please visit [teamknowhow.com](http://teamknowhow.com) or call (UK) 0344 5611234 or (Ireland) 1 890 818 575.



Visit [Partmaster.co.uk](http://Partmaster.co.uk) today for the easiest way to buy electrical spares and accessories. With over 1 million spares and accessories available we can deliver direct to your door the very next day. Visit [www.partmaster.co.uk](http://www.partmaster.co.uk) or call 0344 800 3456 (UK customers only). Calls charged at National Rate.



The symbol on the product or its packaging indicates that this product must not be disposed of with your other household waste. Instead, it is your responsibility to dispose of your waste equipment by handing it over to a designated collection point for the recycling of waste electrical and electronic equipment. The separate collection and recycling of your waste equipment at the time of disposal will help conserve natural resources and ensure that it is recycled in a manner that protects human health and the environment.

For more information about where you can drop off your waste for recycling, please contact your local authority, or where you purchased your product.



#### Notes for Battery Disposal

The batteries used with this product contain chemicals that are harmful to the environment. To preserve our environment, dispose of used batteries according to your local laws or regulations. Do not dispose of batteries with normal household waste.

For more information, please contact the local authority or your retailer where you purchased the product.

#### MPEG-2 NOTICE

Any use of this product in any matter other than personal use that complies with the MPEG-2 standard for encoding video information for packaged media is expressly prohibited without a license under applicable patents in the MPEG-2 Patent Portfolio, which license is available from MPEG LA, LLC, 6312 S. Fiddlers Green Circle, Suite 400E, Greenwood Village, Colorado, 80111 U.S.A.

#### Rovi Proprietary Rights

This item incorporates copy protection technology that is protected by U.S. patents and other intellectual property rights of Rovi Corporation. Reverse engineering and disassembly are prohibited.

#### Restriction on Use & Rovi Trade Mark Rights

Use of the copyright protection technology contained in this product must be authorised by Rovi Corporation and is intended for home and other limited viewing uses only unless otherwise authorised by Rovi Corporation. The names "Rovi Corporation" and "Macrovision" are protected by trademarks.

#### Dolby Audio/Vision

Manufactured under license from Dolby Laboratories. Dolby, Dolby Audio, Dolby Vision and the double-D symbol are trademarks of Dolby Laboratories.

#### Freeview

Availability of channels subject to geographic location and coverage. Aerial upgrade and/or receiver may be required. Visit [freeview.co.uk/availability](http://freeview.co.uk/availability).

Minimum broadband speed of 2Mbps required for catch up and on demand services. Watching on demand and catch up programmes will count towards any monthly broadband data allowance. 7-day catch up or selected channels.

The FREEVIEW words and logos are trade marks of DTV Services LTD. © DTV Services Ltd.

The adopted trademarks HDMI and HDMI High-Definition Multimedia Interface, and the HDMI Logo are trademarks or registered trademarks of HDMI Licensing Administrator, Inc. in the United States and other countries.

For DTS patents, see <http://patents.dts.com>. Manufactured under license from DTS Licensing Limited. DTS, DTS-HD, the Symbol, & DTS or DTS-HD and the Symbol together are registered trademarks and DTS-HD Master Audio is a trademark of DTS, Inc. © DTS, Inc. All Rights Reserved.

All trademarks are the property of their respective owners and all rights are acknowledged.

Dear Customer,

This apparatus is in conformance with the valid European directives compatibility and electrical safety.

European representative of the manufacturer is:

DSG Retail Ltd. (co. no. 504877)  
1 Portal Way, London, W3 6RS, UK

**For Help and Support Call**

**UK: 0344 561 1234**

**Ireland: 1890 818 575**



The product is distributed and warranted exclusive by DSG Retail Ltd.  
"JVC" is the trademark of JVC KENWOOD Corporation, used by DSG Retail Ltd. under license.

(IB-LT-55C898-181219V1)