



## Quick Start Guide

# 2.1 Ch Wireless Soundbar with wired subwoofer

TH-D337B

**Thank you** for purchasing your new JVC Soundbar.

We recommend that you spend some time reading this Quick Start Guide in order that you fully understand how to connect your Soundbar to your TV.

Use your Soundbar instruction manual and TV instruction manual to choose the best way to connect your Soundbar and TV together.



### Unpacking

Remove all packaging from the unit. Retain the packaging. If you dispose of it please do so according to any local regulations. To get the most from this product, you may need to buy an Optical cable.

- |   |   |
|---|---|
| <input checked="" type="checkbox"/> Main Unit                         | <input checked="" type="checkbox"/> Mains Cable                         |
| <input checked="" type="checkbox"/> Remote Control (battery included) | <input checked="" type="checkbox"/> Coaxial Cable                       |
| <input checked="" type="checkbox"/> Subwoofer                         | <input checked="" type="checkbox"/> 3.5 mm to 3.5 mm Stereo Audio Cable |
| <input checked="" type="checkbox"/> Wall Bracket x 2                  | <input checked="" type="checkbox"/> Instruction Manual                  |
| <input checked="" type="checkbox"/> Screw x 4                         | <input checked="" type="checkbox"/> Quick Start Guide                   |
| <input checked="" type="checkbox"/> Dowel x 4                         |   |

### Soundbar Sockets Overview

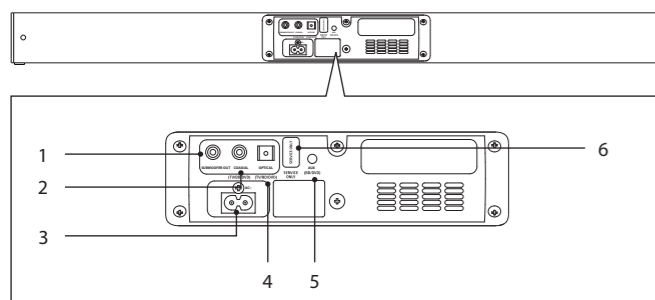

- |                         |                        |
|-------------------------|------------------------|
| 1. SUBWOOFER OUT Socket | 4. OPTICAL Socket      |
| 2. COAXIAL Socket       | 5. SERVICE ONLY Socket |
| 3. AC~ Socket           | 6. AUX Socket          |

### Operating Your Remote Control

#### Remove the Plastic Strip from the Remote Control

The unit has a pre-installed lithium CR2025 battery. Remove the protective tab to activate the remote control battery.

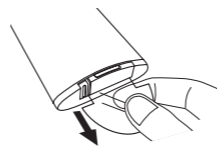

#### Battery Replacement for the Remote Control

- Gently push the tab of the battery tray in and slide it free from the remote control.
- Replace with a new battery
- Slide the battery tray back into the remote control.

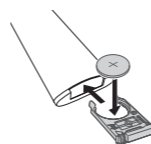
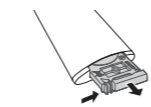

Install the battery correctly in the battery compartment. Normally the battery's positive polarity (+) will face up.

### Connections



Ensure the unit is disconnected from the mains socket before connecting it to other devices.

### Connecting to the TV

#### Method 1: OPTICAL / COAXIAL Connection

Use an optical cable (not included) / coaxial cable (included) to connect the soundbar's **OPTICAL / COAXIAL** socket to the **OPTICAL OUT / COAXIAL OUT** socket of the external device. The simplest option is to connect your soundbar directly to your TV. If you connect the soundbar to another external device (e.g. Blu-Ray player), you will hear the sound from that device through the soundbar.

After the connection is complete,

- Press **⏻** on the unit or remote control to switch on the unit.
- Press **SOURCE** repeatedly to select **Optical** or **Coaxial** mode.



The unit may not be able to decode all digital audio formats from the input source. In this case, the Optical / Coaxial indicator will flash quickly, and the unit will prompt "Unsupported sound format, please refer to the Instruction Book". This is NOT a defect. Ensure that the audio setting of the input source (e.g. TV, game console, DVD player, etc.) is set to **PCM** with optical / Coaxial input.



- DO NOT connect the soundbar with the TV through its **RCA** sockets or **headphone** socket.
- Before connecting the optical cable, remove the protective cap of the **OPTICAL** socket.

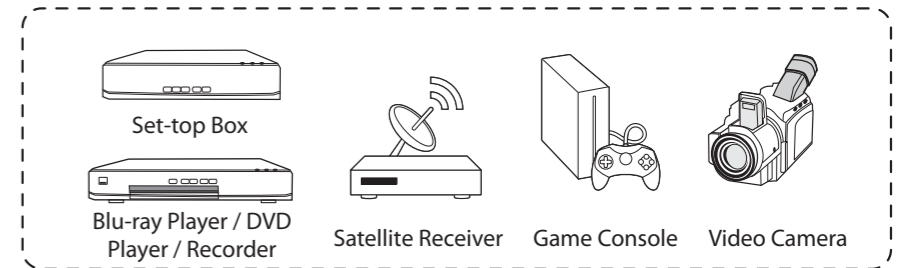
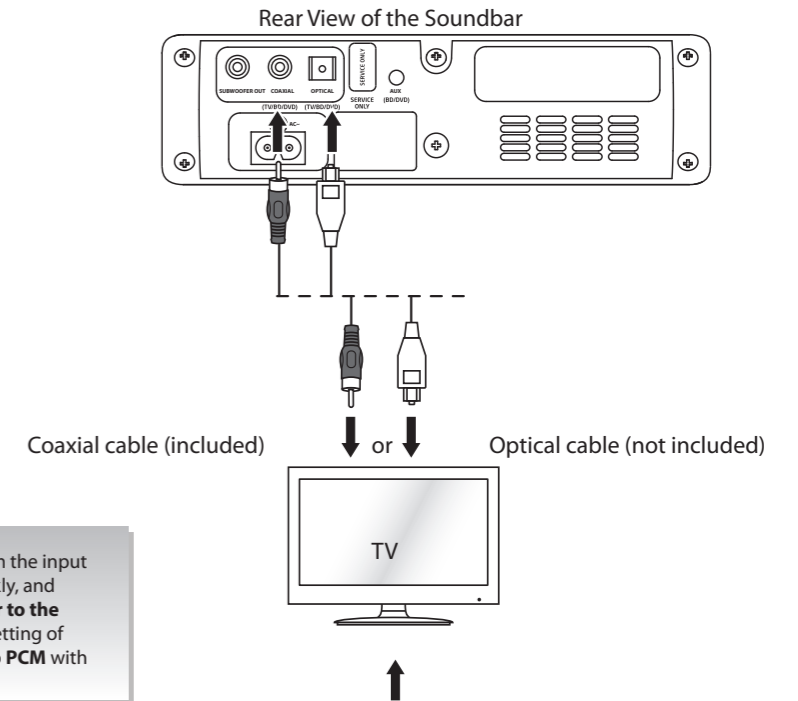

### Connecting an External Audio Device

#### Device

Use a 3.5mm to 3.5mm stereo audio cable (included) to connect the soundbar's **AUX** socket to the headphone socket of the external devices.

After the connection is complete,

- Press **⏻** on the unit or remote control to switch on the unit.
- Press **SOURCE** on the unit or remote control repeatedly to select **AUX IN** mode to play audio from your input device.



- Ensure the colours on the cable plugs match with the colours on the input and output sockets.
- DO NOT connect the soundbar and TV by using the **AUX** socket.

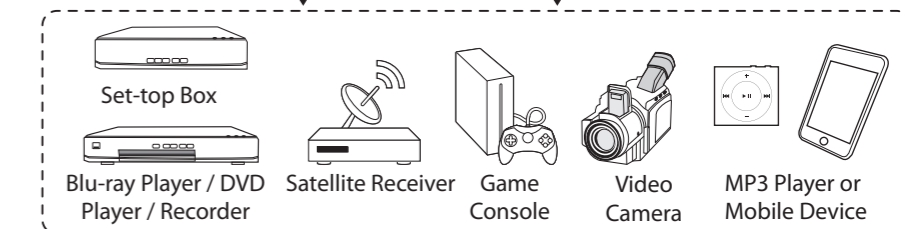
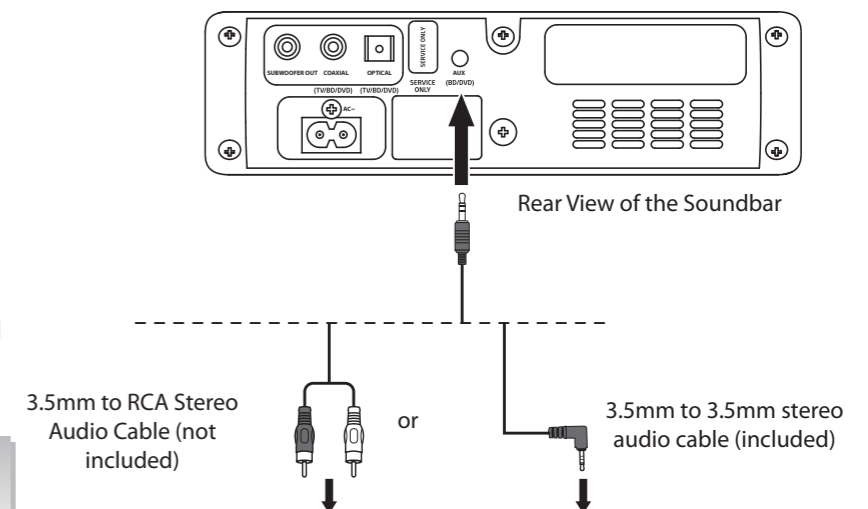

## • Connecting the Subwoofer

Use the Subwoofer cable to connect the Subwoofer to the **SUBWOOFER OUT** socket of the main unit.

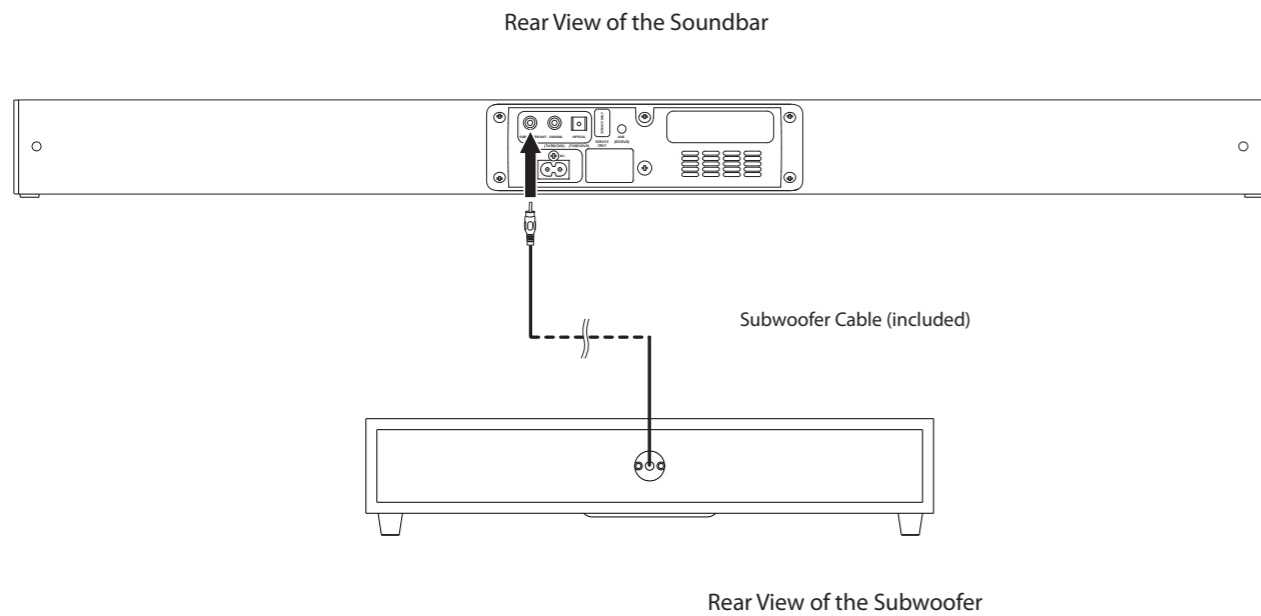

- For optimal sound, always use the supplied subwoofer.
- Make sure that the Subwoofer cable is connected firmly with the main unit and subwoofer. If there is no connection between the main unit and the subwoofer, the subwoofer indicator will flash.

## • EQ and Bass/Treble Level Settings

### Select Equaliser (EQ) Effect

Press the **EQ** button on the unit or the **CUSTOM/MOVIE/MUSIC** button on the remote control to select the preset equaliser effects.

- When **CUSTOM** (Default) is selected, the **COAXIAL** indicator will flash (**Orange**) once.
- When **MOVIE** EQ is selected, the **OPTICAL** indicator will flash (**White**) once.
- When **MUSIC** EQ is selected, the **Bluetooth** indicator will flash (**Blue**) once.



- While the unit is in **COAXIAL**, **OPTICAL**, or **AUDIO IN** mode, it will automatically switch into **MOVIE EQ** effect.
- While the unit is in **Bluetooth** mode, it will automatically switch into **MUSIC EQ** effect.

### Adjusting the Bass/Treble Level in CUSTOM EQ mode

1. Make sure that the EQ is set to **CUSTOM** mode.
2. Press **BASS/TREBLE** on the remote control. The **AUX IN**, **Bluetooth**, **OPTICAL** and **COAXIAL** indicators will flash once.
3. Press **VOL+/VOL-** to adjust the bass/treble level.
4. After about 5 seconds, the **AUX IN**, **Bluetooth**, **OPTICAL** and **COAXIAL** indicators will flash once again to indicate that the unit has exited **BASS/TREBLE** setup.
5. You may now press **VOL+/VOL-** to adjust volume.



- While adjusting the bass/treble level, the status indicator flashes quickly.
- While the **BASS/TREBLE** reaches its maximum or minimum level, the status will flash once if you press **VOL+/VOL-** again.

Front view of the main unit  
(while pressing **BASS/TREBLE** button)

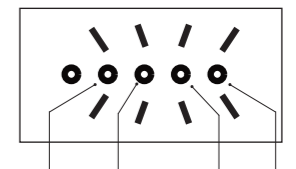

**AUX IN** Indicator (Green)   **Bluetooth** Indicator (Blue)   **OPTICAL** Indicator (White)   **COAXIAL** Indicator (Orange)

The table below also shows the EQ mode supporting bass/treble adjustment.

EQ Mode	Adjusting Bass Level?	Adjusting Treble Level?
<b>Custom</b>	✓	✓
<b>Movie</b>	N/A	N/A
<b>Music</b>	N/A	N/A

## • Connecting to the Mains Supply



- The mains cables are designed for this JVC soundbar only. **DO NOT** use the mains cable for other purposes. Connecting the unit to any other power source may damage the unit.
- Ensure all audio connections of the unit are connected before connecting to the mains power socket.
- Make sure the mains plug is firmly inserted into the mains socket.
- To switch the unit off completely, remove the mains plug from the mains socket.
- Please turn the unit off completely to save energy when not in use.

### Soundbar

Unwind the mains cable to its full length. Connect the end of the mains cable to the **AC~** socket at the rear of the soundbar then connect the mains plug to the mains socket.

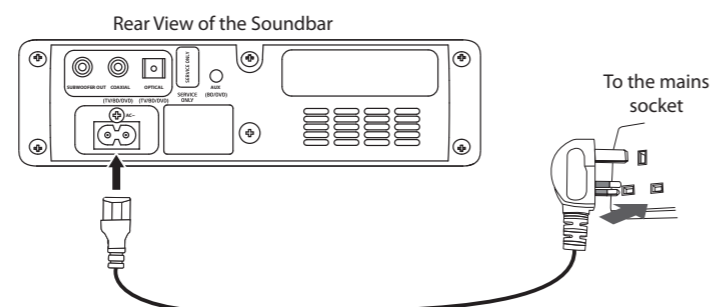

**Currys.co.uk**

**All the support you need.**

Whether it's a tech emergency or you need plain good advice, we're always on hand to help.  
UK: 0344 561 1234  
IRE: 1890818 575

**Partmaster**  
CO.UK

Visit [Partmaster.co.uk](http://Partmaster.co.uk) today for the easiest way to buy electrical spares and accessories. With over 1 million spares and accessories available we can deliver direct to your door the very next day. Visit [www.partmaster.co.uk](http://www.partmaster.co.uk) or call 0344 800 3456 (UK customers only). Calls charged at National Rate.

**Well done,** your new soundbar is now ready to use. You will find that there are many exciting features available. To get to know all these features, please take some time to read the instruction manual provided with your soundbar.

(QSG-TH-D337B-201013V6)