

ESSENTIALS

Freestanding Dishwasher

Installation / Instruction Manual

CDW45W18 / CDW45S18

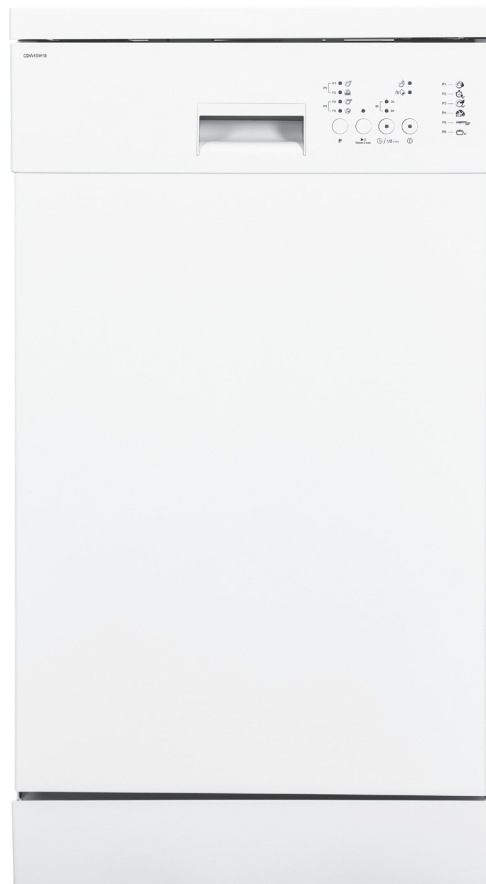

Currys  PC World

Contents

Safety Warnings	5
Unpacking	8
installation	9
Location	9
Product Overview	13
Front View	13
Upper Basket.....	13
Internal View.....	13
Lower Basket	13
Rear View	13
Cutlery Basket.....	13
Control Panel.....	14
Before Operating	15
To Open The Door	15
To Close The Door.....	15
Items Not Suitable for Use in the Dishwasher.....	15
Adding Detergent Or Detergent Tablet	16
Adding Rinse Aid	17
Adjusting the Rinse Aid Reservoir	18
Testing your Water Hardness.....	19
Setting the Salt Consumption Level	20
Adding Salt	21
Loading the Dishwasher	22
Before Loading the Dishwasher	22
Upper Basket.....	23
Adjusting the Upper Basket.....	23
Hinged Cup Rack	24
Loading the Upper Basket for 10 Place Settings	24
Lower Basket	24
Loading the Lower Basket for 10 Place Settings	25
Cutlery Basket.....	25
Loading the Cutlery Basket.....	25
Wash Cycle Table	26
Starting a Wash Cycle	27
Changing a Programme	27
Cancelling a Programme	27
Selecting Half Load Mode	28
Cancelling Half Load Mode.....	28
At the End of a Programme	28
Setting a Timer Delay	28
Switch off the Power and Water When Not in Use	29
Unloading The Dishwasher	29
Cleaning After Use	29
External Care	29

The Door and the Door Seal	29
The Control Panel	29
Internal Care	30
Filtering System.....	30
Spray Arms	31
Frost Precaution	31
Moving the Dishwasher	31
Maintenance for a Prolonged Period of Non-Operation	32
Hints and Tips	33
Fault Code	33
Technical Problems.....	34
Disposal of the Dishwasher	35
Disposal of Packing Material	35
Product Fiche and Specifications	36

Safety Warnings

IMPORTANT SAFETY INSTRUCTIONS READ CAREFULLY AND KEEP FOR FUTURE REFERENCE

- Read all instructions carefully before using the dishwasher and keep them for future reference.
- Retain the manual. If you pass the dishwasher onto a third party, make sure to include this manual.
- This appliance can be used by children aged from 8 years and above and persons with reduced physical, sensory and mental capabilities, or lack of experience and knowledge if they have been given supervision or instruction concerning use of the appliance in a safe way and understand the hazards involved. Children shall not play with the appliance. Cleaning and user maintenance shall not be made by children without supervision.
- Keep ventilation openings in the dishwasher enclosure clear of obstructions.
- Choose a location for your dishwasher away from heat sources such as radiators or fires.
- Young children should be supervised to ensure that they do not play with the dishwasher.
- Keep mains cable out of reach from children.
- Keep children away from detergents and rinse aids. These may cause chemical burns in the mouth, throat and eyes or asphyxiation.
- Keep children away from the dishwasher when the door is open.
- Switch off water and power and unplug before fitting or removing tools/attachments, after use and before cleaning.
- Keep your fingers away from moving parts and fitted attachments.
- Never use a damaged machine.
- If the mains cable is damaged, it must be replaced by the manufacturer, its service agent or a qualified technician in order to avoid a hazard.
- Keep the power unit, mains cable and plug away from water.
- Never exceed the maximum capacities.
- 2 people are required to lift this dishwasher.
- Only use the dishwasher for its intended domestic use.
- This appliance is for indoor domestic use only.
- Do not use with an extension lead or external timer.

WARNING



IT IS HAZARDOUS FOR ANYONE OTHER THAN AUTHORISED SERVICE PERSONNEL TO CARRY OUT SERVICING OF REPAIRS WHICH INVOLVE THE REMOVAL OF COVERS.



TO AVOID THE RISK OF AN ELECTRICAL SHOCK DO NOT ATTEMPT REPAIRS YOURSELF.

- Do not sit or stand on the door or dish rack.
- Do not move your dishwasher by holding the door or its edges. Hold the dishwasher around its sides or base when moving it.
- Do not touch the heating element during or immediately after use.
- Do not operate your dishwasher unless all enclosure panels are properly in place. Open the door very carefully when there is a programme running, as there is a risk of hot water spraying out of the appliance.
- Do not place any heavy objects on the open door. The appliance could tip.
- When loading items to be washed:
 1. Locate sharp items so that they will not damage the door seal;
 2. Warning: Knives and other utensils with sharp points must be loaded in the basket with the points downwards or placed horizontally.
- Do not allow plastic items to come into contact with heating element.
- Check that the detergent receptacle is empty after completion of the wash cycle.
- Do not wash plastic items unless they are marked dishwasher safe or equivalent.
- Use only detergent and rinse aids designed for an automatic dishwasher.
- The mains plug must be made easily accessible or an easily accessible switch must be incorporated in the fixed wiring with at least 3mm contact separation in all poles.
- The door should not be left in the open position since this could present a tripping hazard.
- For energy saving, always remember to switch the dishwasher off when you have finished using it.
- The dishwasher should not be left unattended when in use.

- Remove the door to the washing compartment when removing an old dishwasher from service or discarding it.
- During installation, the power supply cord must not be excessively or dangerously bent or flattened.
- Do not tamper with controls.
- The appliance is to be connected to the water mains using new hose sets.
- The maximum number of place settings to be washed is 10.
- The maximum permissible inlet water pressure is 1Mpa, and the minimum permissible inlet water pressure is 0.03Mpa.
- It is recommended to switch off the power and water when the appliance is not in use.
- Capacity - 10 place settings
- Product dimensions - 820 mm - 850 mm (H) x 448 mm (W) x 598 mm (D)
- Aperture dimensions - 820 mm - 850 mm (H) x 450 mm (W) x 570 mm (D)
- For supporting and fixing the appliance see the Installation section.

Earthing Instructions



WARNING: THIS APPLIANCE MUST BE EARTHED.

- This appliance is equipped with a mains cable having an equipment-earthing conductor and an earthing plug.
- The plug must be plugged into an appropriate outlet that is installed and earthed in accordance with local standards and requirements.



- Improper connection of the equipment-earthing conductor could result in a risk of electric shock.
- The wires in the cord are coloured as follows:
 - Green and Yellow = Earth,
 - Blue = Neutral,
 - Brown = Live.
- Check with a qualified electrician or service representative if you are in doubt whether the appliance is properly earthed or the plug does not fit correctly.
- Never modify the plug provided with the appliance.

Thank you for purchasing your new Currys Essentials Dishwasher.

These operating instructions will help you use it properly and safely.

We recommend that you spend some time reading this installation/instruction manual in order that you fully understand all the operational features it offers.

Read all the safety instructions carefully before use and keep this installation/instruction manual for future reference.

Unpacking

Remove all packaging from the unit. Retain the packaging. If you dispose of it please do so according to local regulations.

The following items are included:

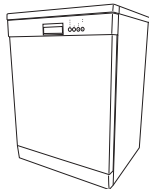

Main Unit



Cutlery Basket



Salt Funnel



U-Shape Hose Holder X 1



Water Supply Hose X 1



Instruction Manual x 1



Water Hardness Testing Strip



This product has been wet tested to ensure correct operation. As a result some water may remain inside the unit. This is normal and safe. Remove any water droplets from the exterior if necessary.



If items are missing or damaged please contact Partmaster (UK only).
Tel: 0344 800 3456 for assistance.

8 * All images are for indication only; please refer to your individual unit for actual item.

INSTALLATION

Location

When selecting a position for your freestanding dishwasher you should make sure the installation surface is flat and firm, and the room is well ventilated. Avoid locating your dishwasher near a heat source, eg. cooker, boiler or radiator. Extreme cold ambient temperatures may also cause the appliance not to perform properly. This dishwasher is not designed for use in a garage or outdoor installation.



All parts removed must be saved to do the reinstallation in the future. Ensure the dishwasher is unplugged and empty. We recommend that 2 people handle the dishwasher during installation.

1. Please ensure the dishwasher is installed by a qualified technician.
2. Ensure there is sufficient clearance on each side of the unit to allow slight sideways movement for servicing when required. Good levelling is essential for correct closure and sealing of the door. When the unit is correctly levelled, the door should not catch the inner liner on either side of the cabinet. The adjustable feet may be loosened or tightened in order to obtain the optimum levelling of the unit.

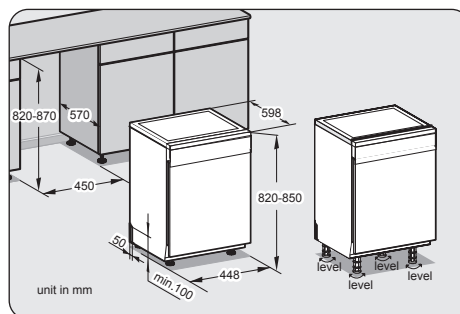
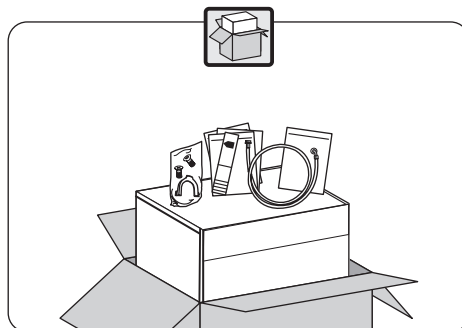

* All images are for indication only; please refer to your individual unit for actual item.

INSTALLATION

3. Do not connect the unit to the mains socket before installation. Ensure you are not installing the unit right in front of the mains socket. This is to avoid potential damage to the back of the unit.

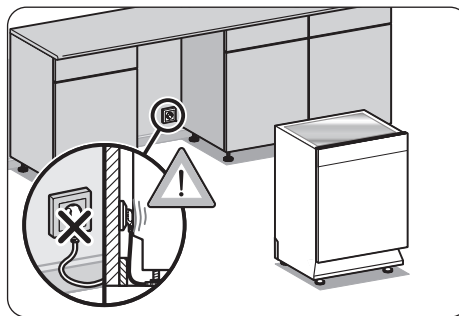

4. Position the dishwasher next to a water tap and a drain. Ensure the water inlet and drain hoses are not kinked or squashed. The unit must not stand on the mains cable.

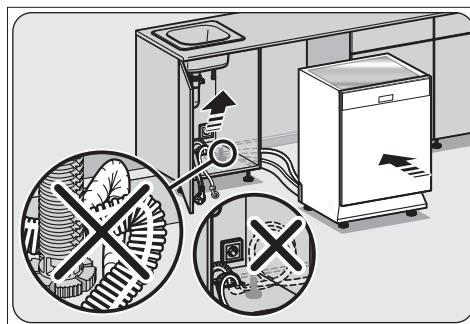

5. Adjust the adjustable feet to obtain the optimum levelling of the unit. The adjustment of the rear feet is via a centre screw at the front.



Making sure the dishwasher is level is very important. If its not level the door may not seal properly and it may leak.

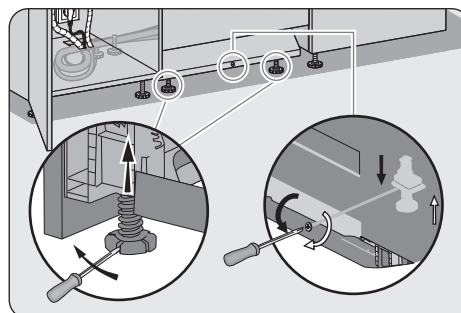

* All images are for indication only; please refer to your individual unit for actual item.

INSTALLATION

6. Make sure your plumbing is suitable for use with the dishwasher. If in doubt contact a qualified plumber. This unit **MUST BE** connected to **COLD WATER MAINS** using the new water supply hose. **OLD HOSE SETS MUST NOT BE RE-USED**. The water pressure from the water mains needs to be at a minimum of 0.03 MPa and a maximum of 1.00MPa.

- Connect one end of the water supply hose to your dishwasher, and then connect the other end of the hose to your water mains. Please ensure the black rubber seal is in place.
- After connecting the hose, turn on your water mains and check for leaks.
- Connect the dishwasher to the mains socket.



You may use a Y-adaptor (not included) for an additional water feed for another appliance, for example a washing machine. This is only applicable for cold water mains. A Y-adaptor is available from most DIY stores.

- Do not bend or kink your drain hose.

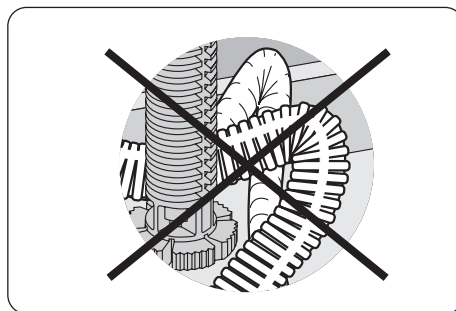
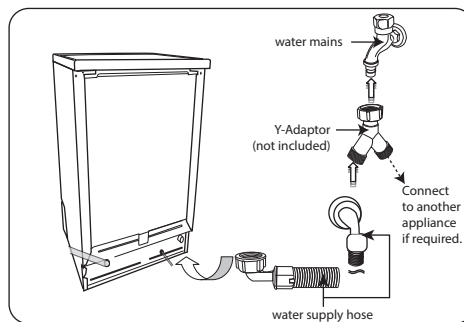

* All images are for indication only; please refer to your individual unit for actual item.

INSTALLATION

- You may use the U-shaped drain hose holder to secure your drain hose and to avoid kinking it.

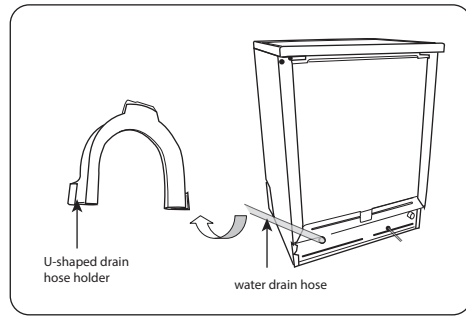

- Secure the water drain hose to the waste pipe to avoid it coming off during the washing process.



- The waste pipe must only be connected to the foul drains and not the surface water drainage system.
- The water drain hose should be placed between 40 cm and 100 cm from the floor level and must not be extended, otherwise the unit may not be able to expel the waste water properly.

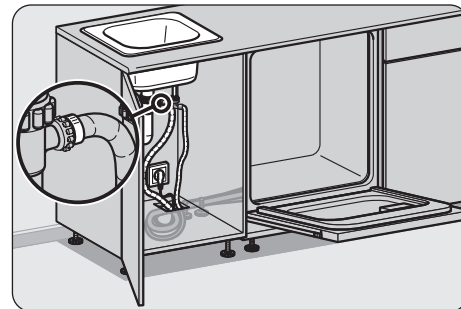
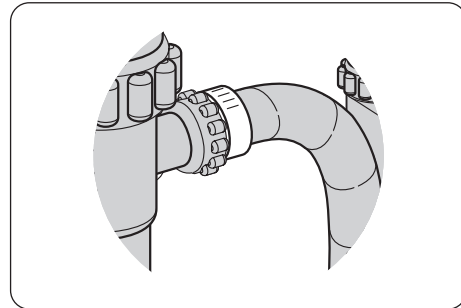

* All images are for indication only; please refer to your individual unit for actual item.

Product Overview

Front View

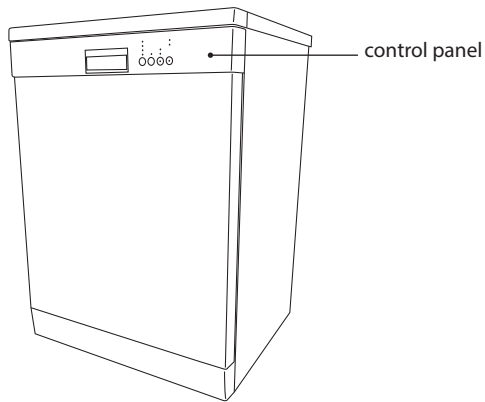

Rear View

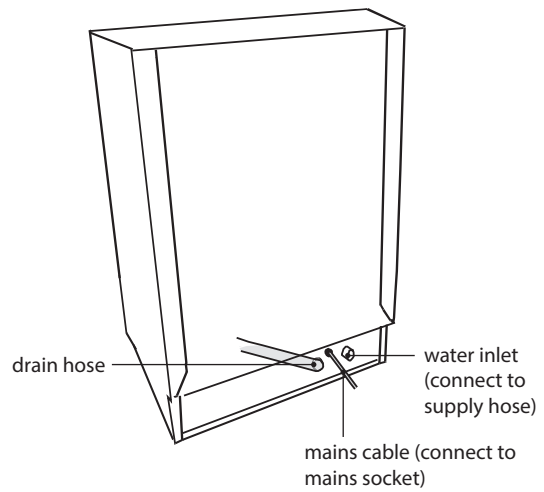

Upper Basket

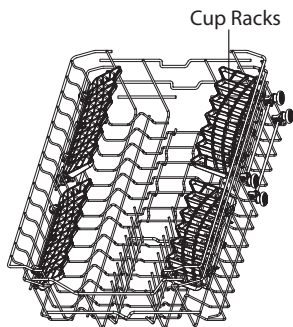

Lower Basket

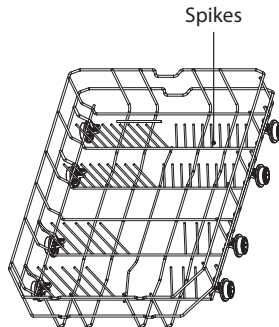

Cutlery Basket

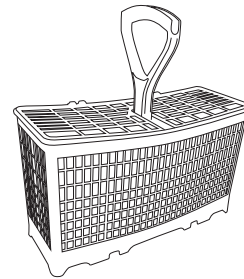

Internal View

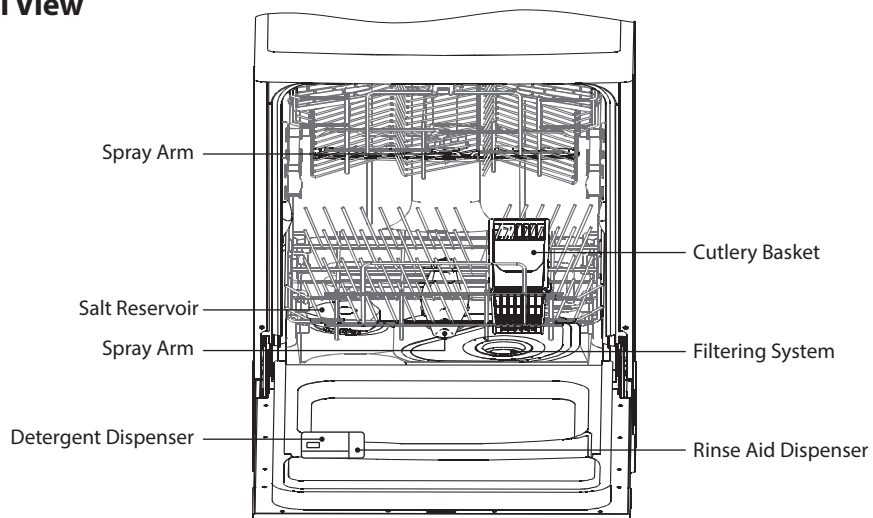

* All images are for indication only; please refer to your individual unit for actual item.

Control Panel

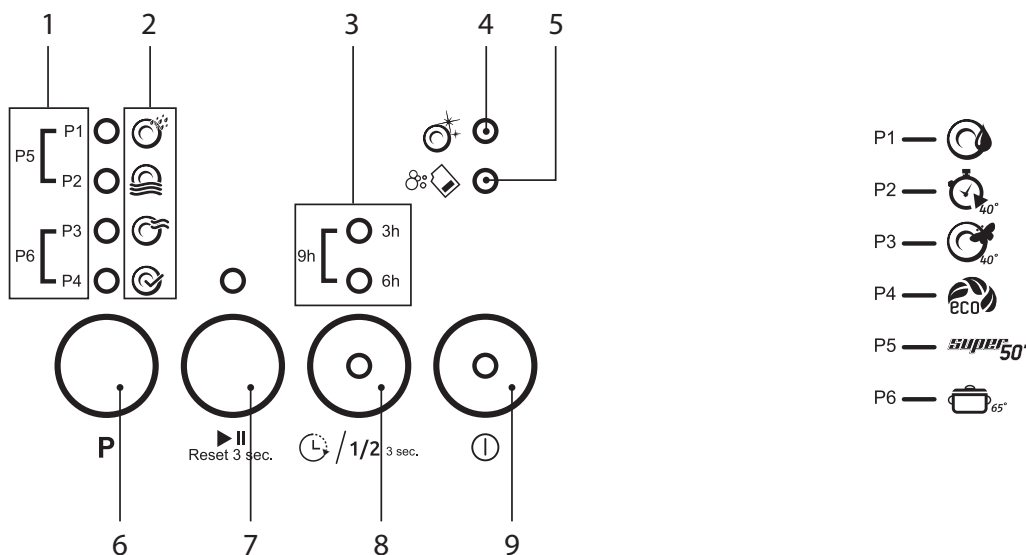

1. Program Settings Indicator

- The LED indicates which program you are selecting when pressing the **P** button.

2. Wash Cycle Status Indicator

- The LED indicates the progress of the wash cycle.
Filling - Heating & Washing - Rinsing - Drying/Finished.

3. Delay Timer Indicator

- Shows if a delay timer is set for 3, 6 or 9 hours.

4. Rinse Aid Indicator

- Shows if rinse aid needs adding.

5. Salt Indicator

- Shows if salt needs adding.

6. Program Button

- Press to select one of the 6 wash programs.

7. Start/Pause and Reset Button

- Press to start or pause the wash cycle.
- Press and hold for 3 seconds to reset the wash cycle.

8. Timer Delay/ Half Load Button

- Press to select a timer delay of 3, 6 or 9 hours.
- Press and hold for 3 seconds to select half load.

9. ON/OFF Button

- Press to turn the dishwasher power on and off.

10. Door Handle

* All images are for indication only; please refer to your individual unit for actual item.

Before Operating

To Open The Door

- Pull the door handle.
- If the door is opened during operation, open the door slightly to avoid water spillage.



If the door is opened during operation, all functions are automatically interrupted.

To Close The Door

- After loading the dishes, push the baskets fully into the dishwasher.
- Lift the door upwards and push until it clicks into position.
- Do not slam the dishwasher door.

Items Not Suitable for Use in the Dishwasher

When purchasing new crockery and cutlery, please make sure they are dishwasher-proof. Some items are not suitable for dishwashers.

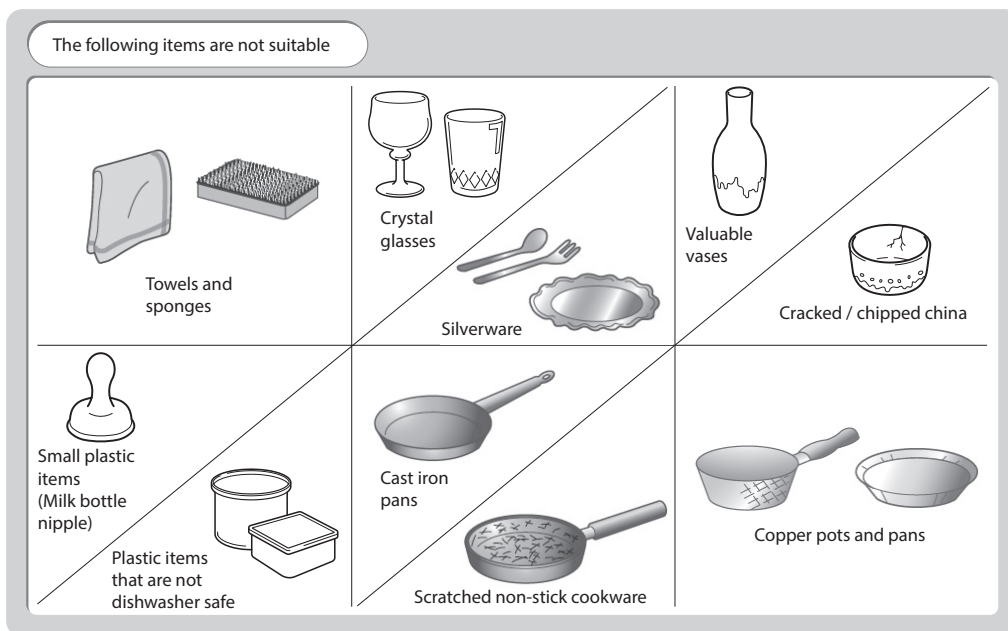

- Wooden cutlery and crockery or items with wooden parts may discolour and fade. The glue used in these items is not dishwasher-proof and wooden handles may come loose after being washed in a dishwasher.
- Craft items, antiques, valuable vases and decorative glassware are also not suitable for dishwashers.
- Plastic items (e.g. tupperware) which are not heat resistant may melt or loose shape due to the high temperature in the dishwasher.
- Copper, brass, tin and aluminium items may discolour or become matt.
- Clouding may occur on glasses and delicate glassware after frequent washing. Do not wash delicate glassware or glassware containing lead crystal, in a dishwasher. Wash delicate glassware by hand instead.
- Silver and aluminium parts have a tendency to discolour during washing. Residues like egg white, egg yolk and mustard often cause discolouring and staining on silver. Therefore, please clean the residues from silver immediately after use.

* All images are for indication only; please refer to your individual unit for actual item.

Adding Detergent Or Detergent Tablet

Only use detergents specifically designed for use in dishwashers. To be more environmentally friendly, please use no more than the correct amount of detergent. Fill the detergent dispenser with detergent power or tablet.

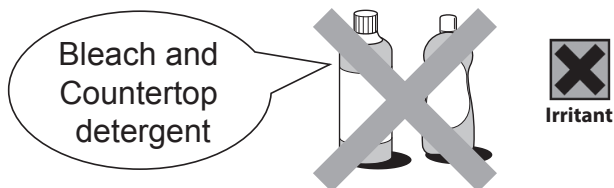

- Keep detergents and bleaches out of the reach of children.
- Irritating to eyes.
- Avoid contact with eyes. In case of contact with eyes, rinse immediately with plenty of water and seek medical advice.
- If swallowed, seek medical advice immediately.

Please follow the steps below to fill the detergent dispenser.

1. Push the button on the lid of the detergent dispenser the flap with slide open.

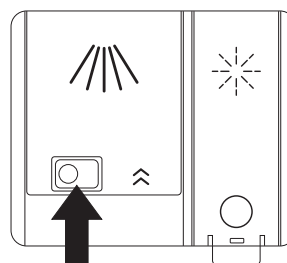

Push to open

2. Fill the detergent dispenser with detergent powder or insert the detergent tablet. The marking indicates the filling level.

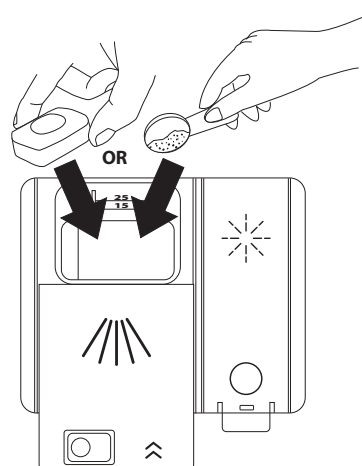

Slide to close

3. Slide the lid firmly so that it clicks into place.

* All images are for reference only; please refer to your individual unit for actual item.

Adding Rinse Aid

Rinse aid helps to ensure water does not cling and leave marks on crockery during the drying phase and helps crockery dry faster after it has been washed. Only pour rinse aid that is for domestic dishwashers into the reservoir. This model is designed to use liquid rinse aids only.

Please follow the steps below to pour the rinse aid into the storage reservoir. The amount will dispense automatically.

1. Open the rinse aid compartment.
2. Fill with the compartment with rinse aid up to the MAX level mark. Be careful not to overfill the reservoir. Wipe up any spills.
3. Close the rinse aid compartment.
 - Rinse aid warning light will illuminate when the reservoir is running out of rinse aid and requires refilling.

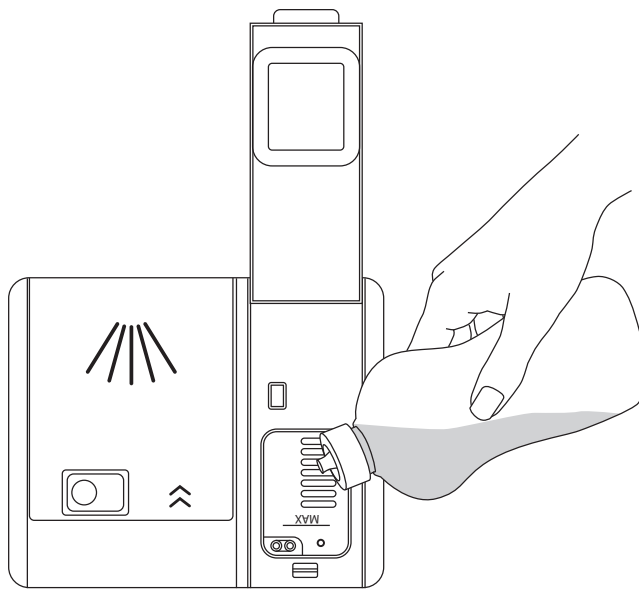

If the water hardness in your area is soft, you may not need rinse aid as it may cause white film to develop on your dishes.



If you decide to use a detergent tablet, you may not need to add rinse aid into the rinse aid reservoir.

Adjusting the Rinse Aid Reservoir

The rinse aid reservoir has five settings. Both the recommended setting and the factory setting is "4." If the dishes are not drying properly or are spotted, adjust to the next higher number until your dishes are spot-free. If you find they are spotted with rinse aid when the cycle has finished, reduce the level.

1. With the dishwasher switched off press and hold the **PROGRAM** button, while holding the **PROGRAM** button down press the **ON/OFF** button.
2. Keep holding the **PROGRAM** button (approx 5 seconds) until all the lights flash twice. One or more of the Program Indicator light will be on, which indicates which rinse aid level is currently set.
3. Press the **PROGRAM** button to scroll through the levels, see the rinse aid table.
4. When the desired level is selected press the **ON/OFF** button. The level is now saved.







Rinse Aid level	Rinse Aid Dose	Rinse Aid level indicator
1	No rinse aid released	
2	1 dose is dispensed	
3	2 doses are dispensed	
4	3 doses are dispensed	
5	4 doses are dispensed	

Testing your Water Hardness

The washing effectiveness of your machine depends on the softness of the tap water. For this reason, your machine is equipped with a system that reduces the hardness in mains water supply. The washing effectiveness will increase when the system is correctly set. To find out the water hardness level of water in your area, contact your local water board or determine water hardness level by using the test strip (if available).

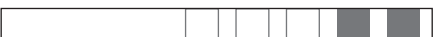
1. Open the testing strip.
2. Run your cold tap for a minute then fill a cup/glass with water.
3. Dip the testing strip into the water for 1 second.
4. Shake off the excess water and wait 1 minute for the result.

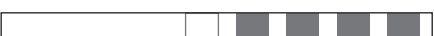
Results Table

Level 1		No Lime
Level 2		Very low lime content
Level 3		Low lime content
Level 4		Medium lime content
Level 5		Medium/High lime content
Level 6		High lime content

Now you have your water hardness result you can set your dishwashers salt consumption level to match.

Setting the Salt Consumption Level

Salt consumption must be adjusted to correspond to the water hardness level in your area. If you don't know how hard the water in your home is, please ask the company that supplies water in your area.

It is recommended that adjustments should be made in accordance with the following chart.

Water Hardness level	German Hardness dH	French Hardness dF	British Hardness dE	Hardness level indicator
1	0-5	0-9	0-6	
2	6-11	10-20	7-14	
3	12-17	21-30	15-21	
4	18-22	31-40	22-28	
5	23-31	41-55	29-39	
6	32-50	56-90	40-63	



1°dh (German degree) = 0.18 mmol/l
 1°fh (French degree) = 0.1 mmol/l
 1°Clark (British degree) = 0.142 mmol/l

Your dishwasher is set to water hardness level 3 in the factory, to change the level follow the instructions below:

1. With the dishwasher switched off press and hold the **PROGRAM** button, while holding the **PROGRAM** button down press the **ON/OFF** button.
2. Keep holding the **PROGRAM** button until all the lights flash on once then release.
One or more of the Program Indicator light will be on, which indicates which hardness level is currently set.
3. Press the **PROGRAM** button to scroll through the levels, see the salt consumption table above.
4. When the desired level is selected press the **ON/OFF** button. The level is now saved.

Adding Salt

If the water in your area is hard, deposits will form on your dishes and utensils. This appliance contains a salt reservoir for you to reduce the hardness of the water.

Please follow the steps below to pour the salt into the salt reservoir. It must be set to correspond to the water hardness level in your area.

1. Remove the lower basket and unscrew the reservoir cap.

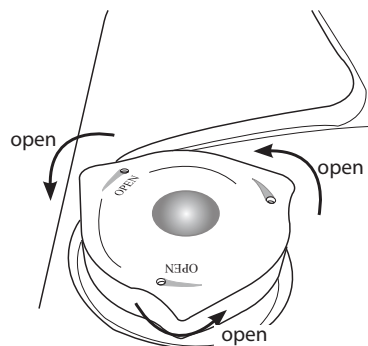

2. Place a funnel over the salt reservoir. Pour in approximately 1 kg to 2 kg of dishwasher salt.
3. Fill the reservoir with water until it overflows (first use only).
4. Clean any excess salt from around the reservoir opening and then screw the cap on again firmly.
5. Run the "Prewash" programme P4 immediately (without any crockery in the dishwasher) to remove any traces of salt from the compartment.

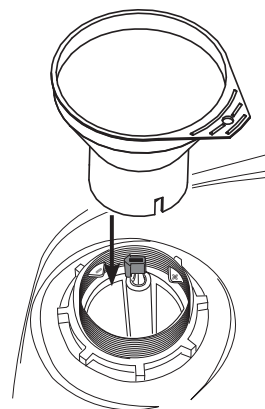

- The salt low warning indicator on the control panel will illuminate when the reservoir is running out of salt and requires refilling.
- The salt low warning indicator will cease to illuminate within a few days (after re-filling), depending on how quickly the salt dissolves.



- Do not use everyday table salt or cooking salt as they contain insoluble substances which could damage the dishwasher.
- Do not pour detergent into the salt container. This will damage the dishwasher.

* All images are for reference only; please refer to your individual unit for actual item.

Loading the Dishwasher

Before Loading the Dishwasher

Please observe the following notes before loading your cutlery and crockery into the basket.

- Remove lipstick stains and any food residues from crockery and dishes. Rinse if necessary.

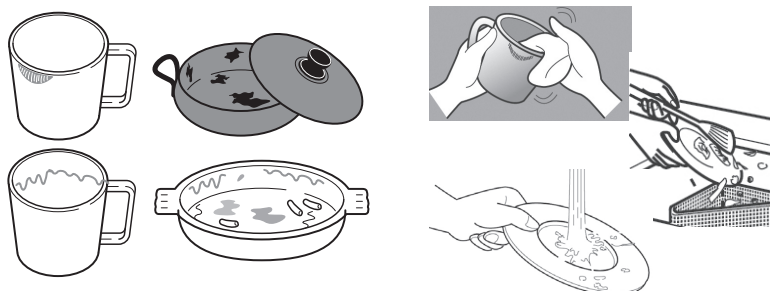

- Dishes and cutlery must not lay inside one another, or cover each other.
- Load your cutlery and crockery so that water can access all surfaces.

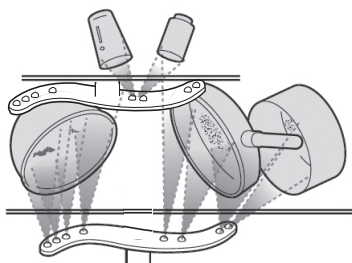

- Ensure all items are securely positioned.
- Hollow items such as cups, glasses, pans, etc. must be placed upside down in the basket.
- Wide based items should be placed at an angle so that water can run off them freely.
- The spray arms must not be blocked by items which are too tall or hang through the baskets. If in doubt, test for free movement by manually rotating the spray arms.
- Ensure that small items cannot fall through the holders in the baskets.



Do not wash items soiled with ash, sand, wax, lubricating grease or paint in the dishwasher. Ash does not dissolve and can distribute in the dishwasher. Wax, sand, lubricating grease and paint can cause damage to the dishwasher.

* All images are for indication only; please refer to your individual unit for actual item.



For safety reasons, do not operate the dishwasher without the upper and lower baskets in place.

Upper Basket

Please use the upper basket for small and lightweight items such as cups, saucers, glasses, dessert bowls, etc. Shallow pans or casserole dishes can also be placed in the upper basket.

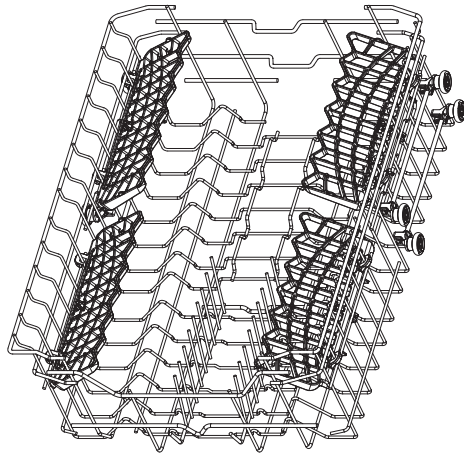

Long items such as soup ladles, mixing spoons and long knives should be placed lying down across the front of the upper basket.

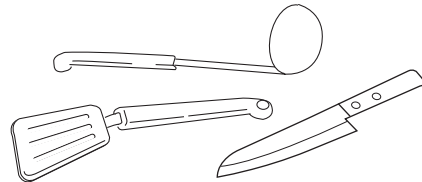

Adjusting the Upper Basket

More space can be created for large items on the upper or lower baskets by adjusting the height of the upper basket.

To adjust the height of the upper basket:

1. Push back the rail stops on both sides.
2. Slide the basket out from the rails and replace at the desired height.
3. Replace the rail stops to their original positions.

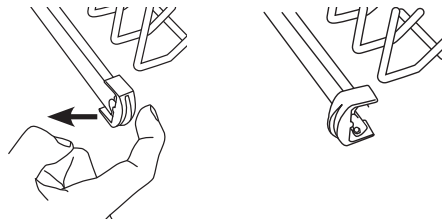

Position of upper basket	Maximum plate diameter	
	Top basket	Bottom basket
Upper position	190 mm	300 mm
Lower position	240 mm	250 mm

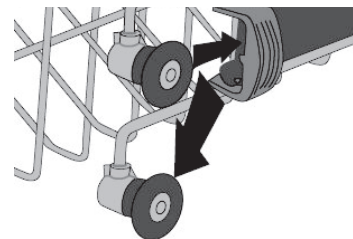

* All images are for indication only; please refer to your individual unit for actual item.

Hinged Cup Rack

To make room for taller items in the upper basket, raise the cup rack upwards. You can then lean the tall glasses against it. You can also remove it when it is not required for use.



To prevent water dripping from the upper basket onto the dishes in the lower basket, we recommend that you empty the lower basket first and then the upper basket.

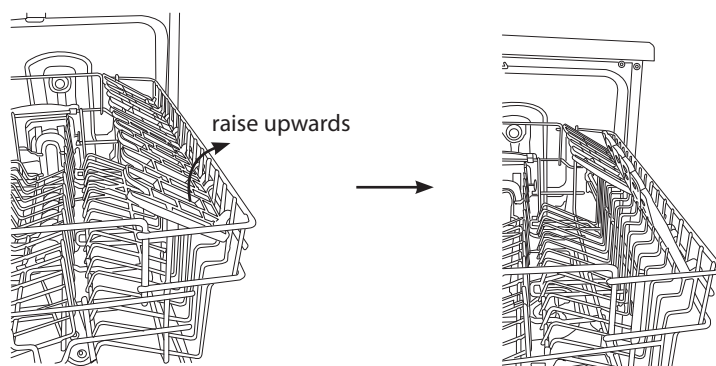

Loading the Upper Basket for 10 Place Settings

For optimum loading of crockery in the upper basket, please refer to the below table and image.

Number	Item
1	Cups
2	Large serving bowl
3	Medium serving bowl
4	Glasses
5	Saucers
6	Small serving bowl

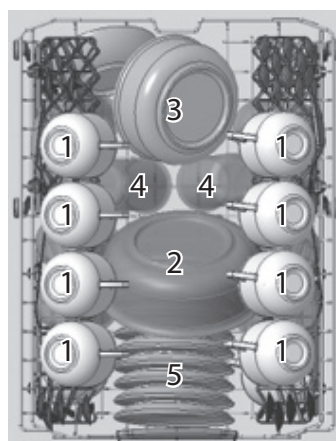

Lower Basket

We recommend that large items and the most difficult to clean items are placed in the lower basket, such as plates, serving platters, saucepans, serving bowls, pots, pans, lids etc. We recommend placing serving dishes and lids at the side of the basket to avoid blocking the rotation of the spray arms.

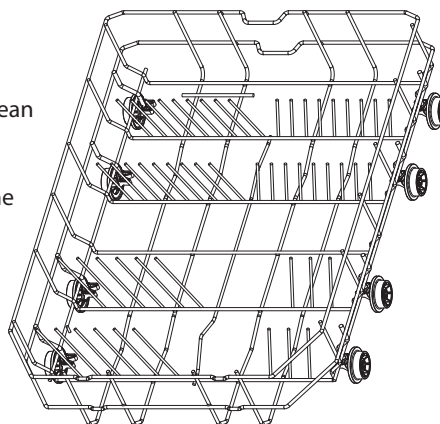

* All images are for indication only; please refer to your individual unit for actual item.

Loading the Lower Basket for 10 Place Settings

For optimum loading of crockery in the lower basket, please refer to the below table and image.

Number	Item
1	Oval platter
2	Dessert dishes
3	Soup plates
4	Dinner plates
5	Cutlery basket

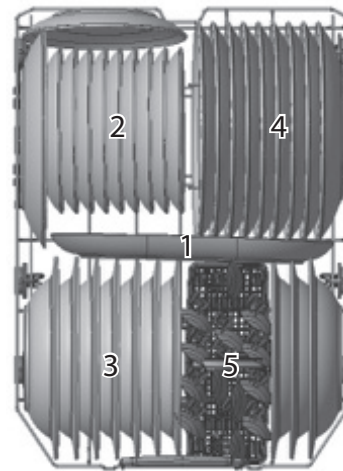

Cutlery Basket

Loading the Cutlery Basket

To make unloading much easier, cutlery should be grouped in zones and placed in the cutlery basket. Please refer to the table below for placement method.

Number	Item
1	Spoons
2	Forks
3	Knives
4	Teaspoons
5	Dessert spoons
6	Gravy ladle
7	Serving spoons
8	Serving fork





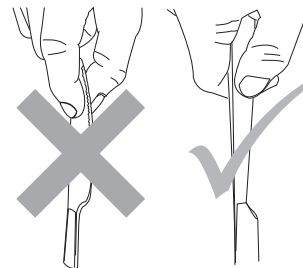
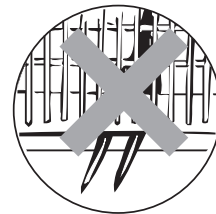



- Do not let any items extend through the bottom of baskets.
- To avoid the risk of injury, please load your knives and forks with handles upwards. Do not hold them by their sharp edges.
- The cutlery basket comes with covers, and they are designed for you to load the cutlery into the appropriate slots. If you use the basket without the cover, it may reduce the washing results of your cutlery.
- Please ensure the cover is securely locked to the basket before operation.
- To comply with Standards of Performance, all cutlery must be loaded according to the instructions in this manual.



* All images are for indication only; please refer to your individual unit for actual item.

Wash Cycle Table

Programme	Cycle Selection Information	Process	Detergent Amount	Running Time (min.)	Energy Consumption (kWh)	Water Consumption (L)
P1 Prewash 	Pre-wash to rinse and loosen residue on soiled dishes. A wash programme is needed when Prewash is finished.	Pre-wash End	None	15	0.02	3.5
P2 Quick 	Coffee, milk, tea, cold meats, vegetables not dried on.	Wash (40°C) Cold Rinse Hot Rinse End	25g	30	0.72	10
P3 Delicate 	Coffee, milk, tea, cold meats, vegetables not dried on.	Prewash Wash (40°C) Cold Rinse Hot Rinse Dry End	25g	74 Half load 65	0.80 Half load 0.78	14.1 Half load 10.3
P4 Eco 	Coffee, milk, tea, cold meats, vegetables not dried on.	Prewash 50°C Wash Hot Rinse Dry End	25g	198 Half load 145	0.73 Half load 0.73	11.0
P5 Super 	Soups, sauces, pasta, eggs, pilaf, potato and oven dishes, fried foods.	Wash (65°C) Warm Rinse Hot Rinse End	25g	50 Half load 46	1.31 Half load 1.21	10.5
P6 Intensive 	Soups, sauces, pasta, eggs, pilaf, potato and oven dishes, fried foods.	Wash (45°C) Wash (65°C) Cold Rinse Hot Rinse Dry End	25g	117 Half load 96	1.50 Half load 1.32	17.6 Half load 13.8

The values declared above are the values obtained under laboratory conditions according to relevant standards. These values can change depending on conditions of product's use and environment (network tension, water pressure, water input temperature and environment temperature).



Condensing dry technology

- Energy is saved by drying the dishes using the remaining heat after the last rinse cycle.
- Wash cycle times are extended due to this drying method.
- Some wash programmes do not have a drying function, please refer to the Wash Cycle Table for more details.

Starting a Wash Cycle

1. Ensure the unit is connected to the mains power and the water supply is on (water pressure between 0.03MPa and 1.00MPa).
2. Open the door. Pull out the lower and upper baskets, load the dishes and push the baskets back. It is recommended that the lower basket is loaded first, and then the upper basket.
3. Pour in the detergent or place the detergent tablet in the detergent compartment and close firmly afterwards.
4. Close the dishwasher door. A click should be heard when the door is closed correctly. Do not slam the door.
5. Press the **ON/OFF** button the LED will light on the button to show the dishwasher is switched on.
6. Select the wash cycle programme based on the loading and soil requirements by pressing the **PROGRAM** button. Please refer to the section "Wash Cycle Table".
7. Press the **START/PAUSE** button the LED will switch off and the LED next to the  will light. The washing cycle will begin shortly.



If you open the dishwasher door during the washing cycle and then close it, the dishwasher will continue the current washing programme once the door is closed.

Changing a Programme

To change the programme if the washing cycle has already started, follow the steps below.

1. Open the door slightly to avoid water spillage before opening the door fully. Check if the unit has dispensed the detergent or detergent tablet. This will depend on how long the washing cycle was running for.
2. If the detergent dispenser is opened, we suggest that you allow the wash cycle to finish.
3. If the detergent dispenser is still closed, close the door then press the **START/PAUSE** button the programme will pause.
4. Press the **PROGRAM** button to select a new programme.
5. Press the **START/PAUSE** to start the new programme.

Cancelling a Programme

To cancel a programme and drain the dishwasher follow the steps below.

1. Press and hold the **START/PAUSE** button for 3 seconds. The current programme will stop and the dishwasher will drain. The  LED will flash while the dishwasher is draining.

At the End of a Programme

At the end of the programme, the end of cycle indicator  will turn on.



It is advisable to leave the door closed until you are ready to unload the crockery. However, leaving the dishwasher door ajar which will speed up the drying process.

Setting a Timer Delay

You can set a delay timer on your dishwasher, this will start the wash programme 3, 6 or 9 hours after setting the timer.

1. After selecting your desired programme, press the  **DELAY TIMER** button, press once for a 3 hour delay, twice for a 6 hour delay and three times for a 9 hour delay. If you continue pressing the button the delay will switch off.
2. Press the **START/PAUSE** button to start the programme the delay LED will flash once to indicate the programme has started, and in 3, 6 or 9 hours the dishwasher will start.

Selecting Half Load Mode

Your dishwasher has a half load setting for when you haven't filled your dishwasher and you just want to wash a few items. The half load mode isn't available on programmes 1 and 2. This will still wash the top and bottom basket, it will reduce the programme time and in some cases it will reduce the water used.

1. Select your desired programme then press and hold the  $1/2$ button for 3 seconds the LED will light on the button to show half load is selected.
2. Press **START/PAUSE** to start the programme.

Cancelling Half Load Mode

If you don't cancel the half load mode it will remain on next time you select a programme.

- Press and hold the  $1/2$ button for 3 seconds, when the LED on the button switches off the mode is off, or press the **ON/OFF** button.

Switch off the Power and Water When Not in Use

To save energy, remember to switch the dishwasher off using the **ON/OFF** button. The dishwasher will continue to use electricity until it is switched off with the **ON/OFF** button.



If the dishwasher is not going to be used for a long period of time, e.g., you are going on holiday, please disconnect the dishwasher from the mains supply and switch off the water supply.

Unloading The Dishwasher

Allowing dishes to cool down before unloading is important as dishes tend to break and chip more easily when they are hot. Therefore, if you open the dishwasher door fully after switching off, it will allow the dishes to cool down much faster.



Unload the lower basket first, followed by the cutlery basket and then the upper basket. This will prevent water drops from the upper basket from falling onto the dishes in the lower basket.

Cleaning After Use

External Care

The Door and the Door Seal

- Clean the door seals regularly with a soft damp cloth to remove food deposits.
- When the dishwasher is being loaded, food and drink residues may drip onto the sides of the dishwasher door. These surfaces are outside the wash cabinet and are not accessed by water from the spray arms. Any deposits should be wiped off before the door is closed.

The Control Panel

If cleaning is required, the control panel should be wiped with a soft damp cloth **ONLY**.



- To avoid penetration of water into the door lock and electrical components, do not use a spray cleaner of any kind.
- Never use abrasive cleaners or scouring pads on the outer surfaces because they may scratch the finish. Some paper towels may also scratch or leave marks on the surface.

Internal Care

Filtering System

The filtering system in the base of the wash cabinet retains coarse debris from the washing cycle. The collected coarse debris may cause the filters to clog. Check the condition of the filters regularly and clean them if necessary under running water.

Follow the steps below to clean the filters in the wash cabinet.

1. Ensure the dishwasher is switched off.
2. Turn the coarse filter anti-clockwise and gently lift it out.

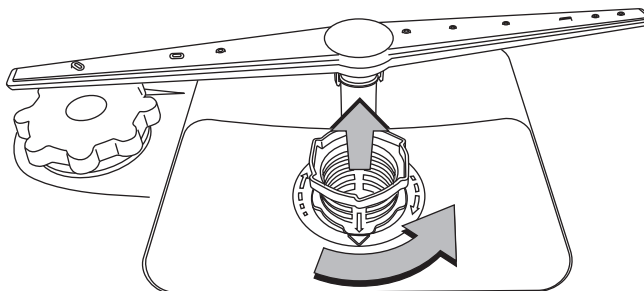

3. Gently lift the main filter and the fine filter with care.

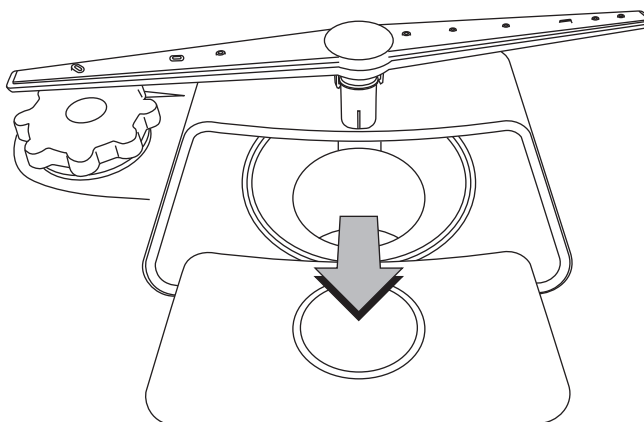

4. Rinse all the filters under running water, including the filter cylinder, and then refit all filters in the reverse order.
5. Gently refit the main filter back with care.
6. Gently re-screw the coarse filter in clockwise direction.

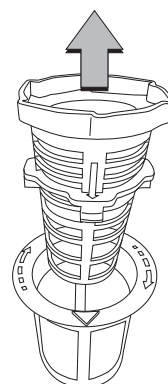

- Do not over tighten the filters.
- Put the filters back in sequence securely, otherwise coarse debris could get into the system and cause a blockage.
- **NEVER** use the dishwasher without the filters in place. Improper replacement of the filters may reduce the performance level of the appliance and damage dishes and utensils.

* Images are for reference only. Please refer to your individual model for details.

Spray Arms

Particles of food can get stuck in the spray arm jets and bearings. The spray arms should be checked and cleaned regularly.

1. Ensure the dishwasher is switched off.
2. Check whether or not the holes for the upper and lower spray arms are clogged. If there is any clogging, remove the spray arms and clean them under running water.
3. You can remove the lower spray arm by pulling it upwards, while the upper spray arm nut can be removed by turning the nut to the left.
4. Be sure that the nut is perfectly tightened when refitting the upper spray arm.

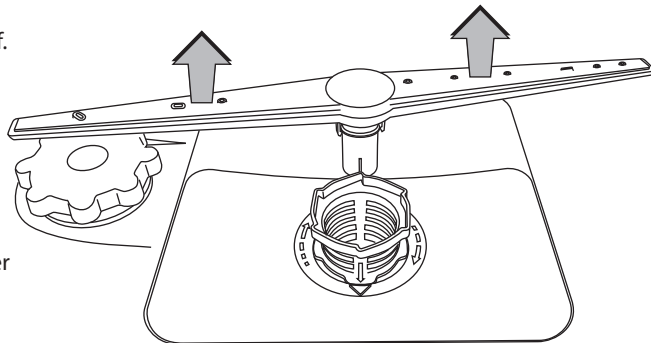

Frost Precaution

Avoid placing the dishwasher in a location where the temperature is below 0°C. If your appliance is left in an unheated place over the winter, you are advised to:

1. Disconnect the unit from the water inlet.
2. Turn on the unit. Select any washing cycle and let it run for 1 minute only. This will allow all the excessive water that remains in the unit to drain out.
3. Disconnect from the mains.
4. Empty the dishwasher.
5. Close the dishwashers door.
6. Disconnect the unit from the water drain. Use a suitable receptacle to catch any residual water in the pipes.

Should you encounter any difficulties with the above steps, please ask a service technician for assistance.

Moving the Dishwasher

If you have to move the unit, for instance due to moving house, you are advised to:

1. Disconnect the dishwasher from the mains.
2. Disconnect the unit from the water inlet and drain. Use a suitable receptacle to catch the water.
3. Remove the unit from the current location with the hoses discharged.
4. Pull the unit out together with the hoses.



- Avoid over tilting the unit during transportation.
- We recommend that 2 people handle the dishwasher during installation.

* Images are for reference only. Please refer to your individual model for details.

Maintenance for a Prolonged Period of Non-Operation

If you are not going to use the unit for a prolonged period of time, you are advised to:

1. Disconnect the dishwasher from the mains.
2. Disconnect the dishwasher from the water inlet and drain. Use a suitable receptacle to catch any residual water in the pipes.
3. Slightly open the door to prevent unpleasant smells building up in the compartment.
4. Ensure the washing compartment of the dishwasher is clean.



















Should you encounter difficulties to do the above steps, please ask a service technician for assistance.

Hints and Tips



- Repairs should only be carried out by a qualified technician in strict accordance with current local and national safety regulations. Unauthorised or incorrect repairs could cause personal injury or damage to the unit.
- Before calling for service, please refer to Hints and Tips to solve some general problems by yourself.

Fault Code

Indicator light flashes					Possible Causes	Remedy
				START/ PAUSE		
					Inadequate water supply	<ul style="list-style-type: none"> • Make sure the water input tap is totally open and that there is no water cut. • Close the water input tap, separate the water input hose from the tap and clean the filter at the connection end of the hose. • Restart your machine, contact your service agent if the error resumes.
					Shut off valve fault	<ul style="list-style-type: none"> • Close the tap. • Contact the service.
					The waste water in the machine cannot be discharged	<ul style="list-style-type: none"> • Water discharge hose is clogged. • The filters of your machine might be clogged. • Power off-on your machine and activate the program cancellation command. • If the error continues, contact your service agent.
					Intended water temperature could not be reached faulty heater and heater sensor	<ul style="list-style-type: none"> • Contact your service agent.
					Alarm is active against water overflow	<ul style="list-style-type: none"> • Power off your machine and close the tap. • Contact your service agent.
					Faulty electronic card	<ul style="list-style-type: none"> • Contact your service agent.

Technical Problems

Technical Problems		
Problem	Possible Causes	Remedy
The dishwasher does not start.	The door is not properly closed.	Close the door firmly.
	The unit is not connected to the mains.	Insert the plug to the mains.
	The unit is not switched on.	Press the ON/OFF button and select a programme.
	No water.	Turn the inlet valve on
	Filters are clogged.	Remove and clean the filters
	A delay timer is set.	Switch the delay time off.
The drain pump is not working properly.	The anti-flooding system has operated.	<ul style="list-style-type: none"> • Disconnect from the mains. • Disconnect the water inlet. • Call a qualified technician.
General Problems		
Problem	Possible Causes	Remedy
Detergent residue is left at the end of the programme.	The detergent slot was still damp when detergent was added.	Make sure the slot is dry before adding detergent.
The detergent dispenser lid cannot be closed properly.	Clogged detergent residue is blocking the catch.	Clean the catch.
Knocking noise in the wash cabinet.	A spray arms is knocking against an item in a basket.	Interrupt the programme, and rearrange the items which are obstructing the spray arm. See the section "Loading the dishwasher".
Smearing appears on glassware and cutlery.	The rinse aid dosage is set too high.	Adjust the rinse aid dispenser to a lower setting.
Dishes, cutlery and glasses are not dry.	The amount of rinse aid may be insufficient, or the rinse aid reservoir is almost empty.	Replenish the reservoir, adjust the rinse aid to a higher setting or change the brand of rinse aid.
	Crockery was taken out of the dishwasher too soon.	Leave the crockery in the dishwasher longer or open the door ajar to help drying once the programme has ended.
White residue is visible on cutlery and crockery, clouding occurs on glassware; film can be wiped off.	Not enough rinse aid was used.	Replenish the reservoir, adjust the rinse aid to a higher setting or change the brand of rinse aid.
	There is not enough salt in the salt reservoir.	Fill the salt reservoir.
	The salt reservoir cap has not been screwed on correctly.	Ensure that it screws back on correctly.
	Unsuitable detergent has been used.	Change your detergent. Use a dishwasher standard powder detergent or tablet.

General Problems (Continue)		
Problem	Possible Causes	Remedy
Glassware is dull and discoloured; film cannot be wiped off.	The glassware is not dishwasher proof. The surfaces are affected.	Wash the non-dishwasher proof glassware by hand instead.
Tea or lipstick stains have not been completely removed.	The wash temperature of the selected programme was too low.	Select a programme with a higher wash temperature.
	The bleaching effect of the detergent used is too low.	Change your detergent.
	Forgot to pre-rinse or remove the stains with napkin prior washing.	Pre-rinse or remove the stains with napkin prior washing.
The door won't close.	The product is not level.	Adjust the feet to make sure the product is level.
The door is leaking slightly.	The product is not level so the door isn't sealing properly.	Adjust the feet to make sure the product is level. Use a spirit level if necessary.

Disposal of the Dishwasher

- When disposing of your old dishwasher, first make it unusable. Disconnect from the electricity and water suppliers, cut off the cable and the plug from the cable. Make the door lock inoperative, so that children cannot accidentally shut themselves in. Make appropriate arrangements for the disposal of the dishwasher.
- At the end of its working life, the product must not be disposed of as urban waste. It must be taken to a special local authority differentiated waste collection centre or to a dealer providing this service. Disposing of a household appliance separately avoids possible negative consequences for the environment and health deriving from an inappropriate disposal and enables the constituent materials to be recovered to obtain significant savings in energy and resources. As a reminder of the need to dispose of household appliances separately, the product is marked with a crossed-out wheeled dustbin.
- Please ensure that it presents no danger to children while being stored for disposal.

Disposal of Packing Material

Please dispose of the plastic wrappings and bags safely and keep out of the reach of babies and young children.

Product Fiche and Specifications

Brand	Essentials
Model	CDW45W18 / CDW45S18
Product Type	Dishwasher
Mass of the Appliance	40kg
Dimensions	820 mm - 850 mm (H) x 598 mm (W) x 450 mm (D)
Capacity	10 Place Settings
Water Pressure Required	0.03 - 1.00MPa
Rated Voltage	230-240V~50Hz
Energy Efficiency Class ¹	A++
Annual Energy Consumption ²	211 kWh
Energy Consumption	0.73 kWh
Off Mode Power Consumption	0.50 W
Left-on Mode Power Consumption	1.00 W
Annual Water Consumption ²	3080 litres
Drying Efficiency Class ³	A
Standard Programme Name ⁴	ECO
Programme Time for Standard Cycle	198 min
Noise Level	49 dB(A)
Mounting	Freestanding

Features and specifications are subject to change without prior notice.

Note:

- 1 A + + + (highest efficiency) to D (lowest efficiency)
 - 2 Energy consumption 211 kWh per year, based on 280 standard cleaning cycles using cold water fill and the consumption of the low power modes. Actual energy consumption will depend on how the appliance is used. Water consumption 3080 liters per year based on 280 standard cleaning cycles. Actual water consumption will depend on how appliance is used.
 - 3 Drying efficiency class A on a scale from G (least efficient) to A (most efficient).
 - 4 The "Eco 50 °C" is the standard cleaning cycle to which the information in the label and the fiche relates. This programme is suitable to clean normally soiled tableware and it is the most efficient programme in terms of combined energy and water consumption.
- The device meets the European standards and the directives in the current version at delivery:
 - LVD 2006/95/EC
 - EMC 2004/108/EC
 - ERP 2009/125/EC
 - The above values have been measured in accordance with standards under specified operating conditions. Results may vary greatly according to quantity and pollution of the dishes, water hardness, amount of detergent, etc.

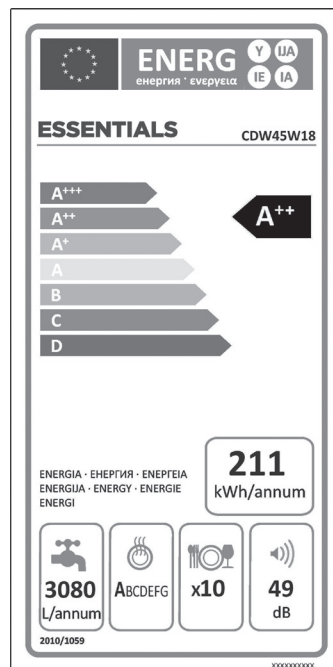
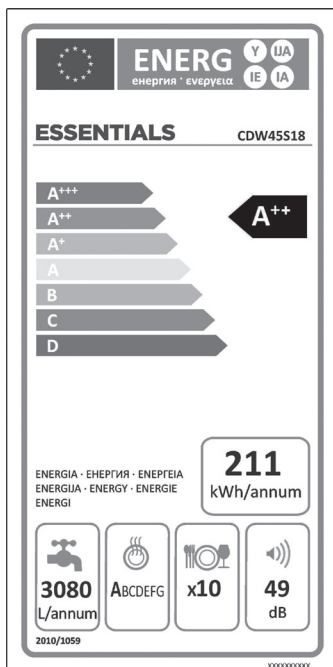



Team Knowhow

Help with all life's kit

For general information about this appliance
and handy hints and tips, please visit

www.TeamKnowhow.com/discover or call **0344 561 1234**.

Partmaster
_____.co.uk

Visit Partmaster.co.uk today for the easiest way to buy electrical spares and accessories. With over 1 million spares and accessories available we can deliver direct to your door the very next day.

Visit www.partmaster.co.uk or call 0344 800 3456 (UK customers only). Calls charged at National Rate.



The symbol on the product or its packaging indicates that this product must not be disposed of with your other household waste. Instead, it is your responsibility to dispose of your waste equipment by handing it over to a designated collection point for the recycling of waste electrical and electronic equipment. The separate collection and recycling of your waste equipment at the time of disposal will help conserve natural resources and ensure that it is recycled in a manner that protects human health and the environment.

For more information about where you can drop off your waste for recycling, please contact your local authority, or where you purchased your product.

DSG Retail Ltd. (co. no. 504877)
1 Portal Way, London, W3 6RS, UK

CDW45W18/S18_180328V1